



**FAHRZEUGEINRICHTUNGEN**  
**FITTINGS FOR COMMERCIAL VEHICLES**



# IVECO DAILY







StoreVan ist weltweit der einzige Hersteller von Nutzfahrzeugeinrichtungen, der mit dieser Technologie arbeitet.

StoreVan is the sole LCV's equipment manufacturer worldwide to make use of this technology.

## TECHNOLOGIE

### GALVANNEALED STAHL

Galvannealed Blech ist eine Variante von feuerverzinktem Blech. Das Produkt unterliegt einem Feuerbeschichtungsprozess und wird bis ca. 550 °C erhitzt. Dies ermöglicht es dem Zink mit dem Stahlblech eine Legierung einzugehen. Das Ergebnis ist eine Beschichtung mit einer gleichförmigen, feinkörnigen Kristallstruktur an der Beschichtungsfläche und einer **sehr hohen Oberflächenqualität und Korrosionsbeständigkeit**.

Dieses Verfahren ist ideal für Automotive Anwendungen. StoreVan hat diese Technik nun auch im Bereich Nutzfahrzeugeinrichtungen implementiert.

### DAS VERFAHREN DER KATHODISCHEN ACRYL-TAUCHLACKIERUNG

Die kathodische Acryl-Beschichtung ist eine Oberflächenbehandlung, die den einzelnen Teilen der Einrichtung eine **extrem hohe Korrosionsbeständigkeit** verleiht. Das Tauchverfahren gewährleistet eine **gleichmäßige Beschichtung** und einen lang anhaltenden Schutz egal gegen welche Stoffe. Das Acrylharz schützt den Lack bei direkter Belichtung durch die Witterung gegen Ausbleichen und gegen Veränderungen der Korrosionsbeständigkeit.

- Korrosionsbeständigkeit von über 500 Stunden (ASTM D1735 Luftfeuchtigkeit)
- Ausgezeichnete Härte mit einem Mindestrating von 2H





#### STORE VAN ORANGE PLANET

Nachhaltigkeit und ökologische Entwicklung sind Themen von großem, aktuellem Interesse, entstanden durch das steigende Bewusstsein, dass auf die Umweltbalance aufgrund der zyklischen Veränderungen und Erneuerungen geachtet werden muss.

#### STORE VAN ORANGE PLANET

Environmental sustainability and eco-compatible development are topics of great interest and relevance, arising from the growing awareness that it is important to pay attention to the environmental balance.

## TECHNOLOGIES

### GALVANNEALED STEEL

Galvannealed sheet is a variant of hot-dip galvanized sheet. The product is subject to a hot-dip galvanization process and subsequently heated to approximately 550°C, combining the zinc with the sheet surface to make an alloy with iron. The result is a uniform zinc coating with a fine-grained crystalline structure along with a **much higher surface quality and corrosion resistance**. This process is ideal for automotive applications. StoreVan has introduced and implemented this technology in the commercial vehicles equipment field.

### CATHODIC DIP PAINTING WITH ACRYLIC RESIN

Cataphoresis painting is a paint surface treatment able to give the equipment elements a **remarkable resistance to corrosion**; characterized by **uniform deposit** of an acrylic resin on the element surface, it ensures long lasting, high protection against chemical agents and other types of surface attacks. The acrylic resin allows a direct exposure to atmospheric agents without altering its technical features. This process ensures an increased protection against rust.

- Corrosion resistance of more than 500 hours (humidity ASTM D1735)
- Excellent hardness with a minimum rating of 2H





# FLEXIBLES BEFESTIGUNGSSYSTEM

## FLEXIBLE FIXING SYSTEM

### DIE FLEXIBILITÄT UND DAUERHAFTIGKEIT DER STORE VAN TRANSPORTEREINRICHTUNGEN

Store Van benutzt zur Befestigung der Transporterregale am Fahrgestell des Nutzfahrzeuges ein spezielles Schienensystem und sorgt damit für eine besonders flexible Positionierbarkeit der Module und eine maximale Nutzung der Innenräume des ausgestatteten Transporters.

Bei diesem System werden Bügel benutzt, die in der Gesamtlänge der Schiene gleiten, anstatt direkt an den Verstärkungen des Fahrgestells angenietet zu sein, was beim Entwurf der Transportereinrichtung grundsätzlich zu einer starren Raumnutzung zwingt. Die von Store Van verwendete Schiene wird an die vertikalen Pfosten der mobilen Werkstatt befestigt und hat die doppelte Funktion einer gleichmäßigen Verbindung der Transporterregale am Fahrzeugrahmen und einer homogenen Verteilung aller dynamischen Kräfte, denen die Einrichtung während der Fahrt ausgesetzt ist.

Die Befestigungsbügel für die Verbindung der Schiene am Modul besitzen ein spezielles Gelenk, das die bei der Fahrt verursachten Vibrationen dämpft, indem es sich den Torsionsbewegungen des Fahrgestells anpasst, vor allem beim Kurvenfahren.

Dieses System bietet beim Entwurf unserer Transportereinrichtungen eine erhebliche Gestaltungsfreiheit, wobei in jedem Fall hohe Sicherheits-, Stabilitäts- und Dauerhaftigkeitsstandards garantiert werden.

Bei allen unseren Befestigungssystemen können für die Module Schnellankupplungs- und -loskupplungssysteme mit Feststellgriffen eingesetzt werden, die eine werkzeuglose Demontage der Einrichtung ermöglichen. Dadurch kann das Regal Ihrer mobilen Werkstatt, wie in der RICHTLINIE 2014/47 EU, KAP. 1, Artikel 3, Absatz 5 beschrieben, als transportiertes Material oder als Hilfsmittel für die Sicherheit der nicht dauerhaft am Fahrzeug befestigten Ladung erklärt werden.

### FLEXIBILITY AND DURABILITY OF STORE VAN EQUIPMENT

Store Van uses a special rail anchoring system to secure shelving units for vans to the chassis of your vehicle, improving the flexibility of module arrangement and maximising the internal spaces of your van.

This system is based on brackets sliding all along the rail rather than being riveted to chassis reinforcements, thus offering great flexibility in the management of internal spaces. The Store Van rail is secured to the uprights of your mobile workshop and has a two-fold function: it connects shelving units uniformly to the frame of your vehicle, and it evenly distributes all the dynamic forces your van equipment is subject to while travelling. Special vibration damping joints, fitted on the brackets connecting the rail to the module, absorb the torsional vibration applied on the chassis especially when driving on a curve.

Thanks to this system, our fittings for vans can be designed with maximum freedom, always ensuring high safety, stability and durability standards.

Our anchoring systems are fitted with quick locking/unlocking devices with adjustable handles, so users can remove the fittings with no need of tools. Hence the shelving units of your mobile workshop may be considered as transported goods or load securing fittings not permanently fixed to the vehicle, in compliance with Directive 2014/47EU, Chapter 1, Article 3, Item 5.





# ZERTIFIZIERUNGEN CERTIFICATIONS

## ZERTIFIZIERTE PRODUKTION

- Nach ISO 9001:2015 zertifiziert.
- Erfolgreicher CRASH TEST durchgeführt nach ECE-R17 mit einer Aufprallgeschwindigkeit von 50 Km/h.
- GS-Zertifizierung für Inneneinrichtungen und Laderampen.
- GS-Zertifizierung für Dachträger und Leiterträger.

## CERTIFIED PRODUCTION

- ISO 9001:2015 certified.
- Brilliantly passed the CRASH TEST carried out according to the most recent European regulations ECE-R17 with impact at 50 Km/h.
- GS certification for interior fittings and loading ramps.
- GS certification for roof and ladder racks.

**CRASH TEST**  
ECE-R17





## Die Grundlage für den sicheren Schutz von Fahrzeugen

The basis for the safe  
protection of vehicles





## LADUNGSSICHERUNG FÜR TRANSPORTER UND SICHERE BEFESTIGUNG DER WAREN

Durch die Umsetzung der Richtlinie 2014/47/EU wird eine Intensivierung der Kontrollen an Kraftfahrzeugen für die Güterbeförderung der Klassen N2 und N3 und eine aufmerksamere Kontrolle der Ladungssicherung erfolgen. Die Richtlinie ermöglicht es den Mitgliedsstaaten, Fahrzeuge, die über den Anwendungsbereich hinausgehen, wie z.B. Nutzfahrzeuge der Klasse N1, technischen Kontrollen zu unterziehen, sowie weitere Aspekte des Transports und der Straßenverkehrssicherheit zu kontrollieren.

### SCHUTZSYSTEM DES LADERAUMS UND LADUNGSSICHERUNG

Das neue integrierte Transporter-Schutzsystem von Store Van folgt den Leitlinien der neuen Richtlinie 2014/47/EU und erlaubt eine **flexible und sichere Befestigung** der Ladung an den Ladeflächen und Innenwänden des Fahrzeugs.

Mit den „Airline“ Festhaltekomponenten und dem Einbau zahlreicher Zubehörteile wie Riemen, Netze und teleskopische Spannstrangen kann der Fahrzeugbenutzer seine Festhalteplattform einfach, ergonomisch und in Entsprechung der europäischen Richtlinien gestalten.

Das System umfasst die folgenden Bestandteile:

- Mehrschichtige Bodenplatten für Transporter mit Phenolharzverleimung, mit eingelassenen Aufnahmen für die Originalverankerungen des Fahrzeugs und mit zusätzlichen bodenplattenflächigen Verankerungen (S. 10) mit einer Zugkraft von 200 daN;
- am Fahrgestell verankerte „Airline“ Aluminiumschienen (S. 11);
- hochflexible und hochresistente Polypropylenpaneele für den internen Schutz der Karosserie vor Stößen (S. 8).

### DAS ANBRINGEN DES NEUEN SCHUTZSETS SORGT FÜR EINE LANGE REIHE VON VORTEILEN:

- Der Fahrzeugbenutzer kann die Ladung schon mit den Zurrgurten sicher an den „Airline“ Schienen befestigen.
- Das integrierte Befestigungsset hält die Karosserie länger in gutem Zustand.
- Das Schutzsystem verleiht einen Mehrwert, der schon auf dem Markt der Neufahrzeuge sehr wichtig erscheint und bei Gebrauchtfahrzeugen, die normalerweise Karosserieschäden aufweisen, sogar von grundlegender Bedeutung ist.



## VAN LOAD SECURING AND CARGO RESTRAINT

Transposition of directive 2014/47/EU will intensify control of N2 and N3 category transport vehicles and cargo securement enforcement. Under this Directive, the Member States can subject vehicles that are beyond the scope of the Directive, such as N1 category vehicles, to technical inspections, and also monitor other transport and road safety aspects.

### CARGO AREA PROTECTION SYSTEM AND CARGO RESTRAINT

The new Store Van integrated system for van protection follows the guidelines of Directive 2014/47/EU while making the **anchoring of the cargo to the van floor and walls flexible and safe.**

With the use of „Airline“ securing components and integration of many different accessories such as belts, nets and telescopic load restraining bars, final users may configure their cargo platform easily and cheaply and in conformity with the European Directive.

The system uses:

- phenolic resin plywood floor panels, arranged to fit original anchoring fittings and additional 200 daN strength lashing points (page 10), flush with the floor panel;
- aluminium „Airline“ bars anchored to the chassis (page 11);
- highly flexible and resistant polypropylene panelling to protect the internal body shell from accidental impacts (page 8).

### THE NEW LOAD SECURING SYSTEM OFFERS NUMEROUS ADVANTAGES:

- users can safely secure the load to the „Airline“ bars with load restraining belts;
- the integrated load securing system extends the body's good condition over the time;
- the protection system offers new added value, an important economic aspect for a new vehicle and a fundamental characteristic for a second-hand vehicle, that is usually exposed to damage.

SAFETY CROSS: Fixierpunkte in Längs- und Querrichtung nach Anfrage.  
SAFETY CROSS: longitudinal and transversal fixing points upon request.

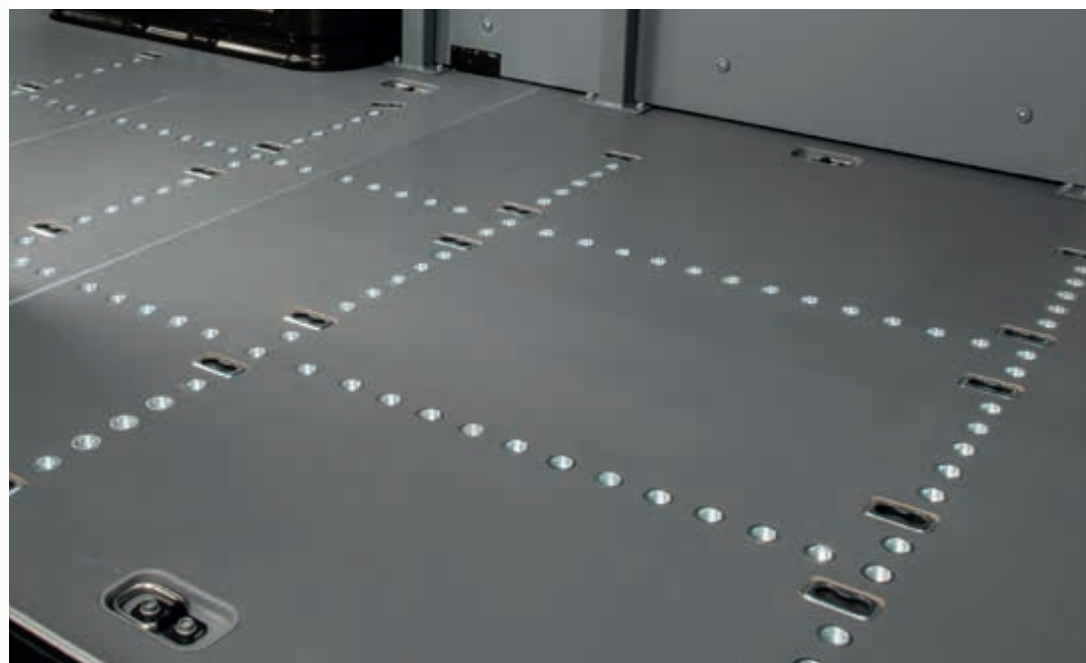





- Seitenverkleidungen für Fahrzeug mit rechter Schiebetür und Seitenwänden aus Vollblech.
- Linings for right side door vehicle with metal sheet sidewalls.

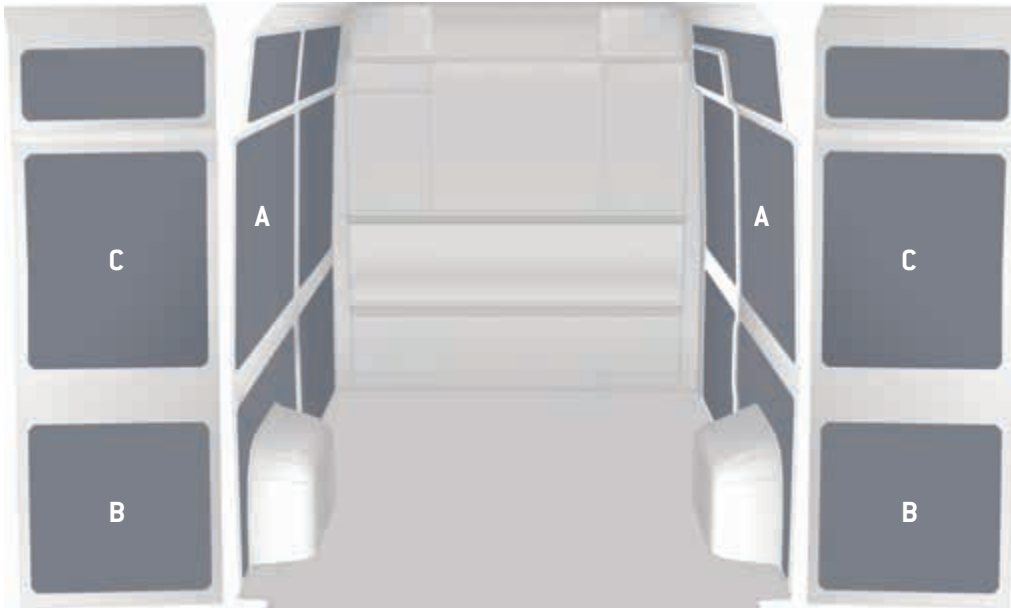
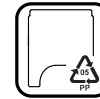

**HONEYCOMB PANEL - A**

- Seitenverkleidung aus Polypropylen für:
  - linke Seitenwand
  - rechte Seitenwand und Schiebetür
- Polypropylene linings for:
  - LH sidewall
  - RH sidewall and sliding door

**HONEYCOMB PANEL - B**

- Seitenverkleidung aus Polypropylen für:
  - unteren Teil der Heckflügeltüren
- Polypropylene linings for:
  - lower part of rear hinged doors

**HONEYCOMB PANEL - C**

- Seitenverkleidung aus Polypropylen für:
  - oberen Teil der Heckflügeltüren
- Polypropylene linings for:
  - upper part of rear hinged doors

FAHRZEUG VEHICLE	SEITENVERKLEIDUNG LINING	
	A+B	C
	ART.	ART.
Fahrzeugtyp - Model L1 H1 · 3000 H1 <sup>A</sup>	<b>F22 HP DA10H1 JO 01</b> 14,35 kg	<b>F22 HP DADRH1 JO 01</b> 1,93 kg
Fahrzeugtyp - Model L2 H1 · 3520 H1 <sup>A</sup>	<b>F22 HP DA20H1 JO 01</b> 16,15 kg	<b>F22 HP DADRH1 JO 01</b> 1,93 kg
Fahrzeugtyp - Model L2 H2 · 3520 H2 <sup>A</sup>	<b>F22 HP DA20H2 JO 01</b> 19,86 kg	<b>F22 HP DADRH2 JO 01</b> 2,77 kg
Fahrzeugtyp - Model L2L H2 · 3520L H2 <sup>A</sup>	<b>F22 HP DA2LH2 JO 01</b> 22,55 kg	<b>F22 HP DADRH2 JO 01</b> 2,77 kg
Fahrzeugtyp - Model L2L H3 · 3520L H3 <sup>A</sup>	<b>F22 HP DA2LH3 JO 01</b> 24,43 kg	<b>F22 HP DADRH3 JO 01</b> 3,14 kg
Fahrzeugtyp - Model L3 H2 · 4100 H2 <sup>A</sup>	<b>F22 HP DA30H2 JO 01</b> 29,92 kg	<b>F22 HP DADRH2 JO 01</b> 2,77 kg
Fahrzeugtyp - Model L3 H3 · 4100 H3 <sup>A</sup>	<b>F22 HP DA30H3 JO 01</b> 34,61 kg	<b>F22 HP DADRH3 JO 01</b> 3,14 kg
Fahrzeugtyp - Model L3L H2 · 4100L H2 <sup>B</sup>	<b>F22 HP DA3LH2 SO 01</b> 32,87 kg	<b>F22 HP DADRH2 JO 01</b> 2,77 kg
Fahrzeugtyp - Model L3L H3 · 4100L H3 <sup>B</sup>	<b>F22 HP DA3LH3 SO 01</b> 37,77 kg	<b>F22 HP DADRH3 JO 01</b> 3,14 kg



<sup>A</sup> Heckantrieb, Einzelbereifung  
Rear-wheel drive, single wheels

<sup>B</sup> Heckantrieb, Zwillingsbereifung  
Rear-wheel drive, twin wheels





- Bodenplatte für Fahrzeug mit rechter Schiebetür und Seitenwänden aus Vollblech.
- Flooring for right side door vehicle with metal sheet sidewalls.

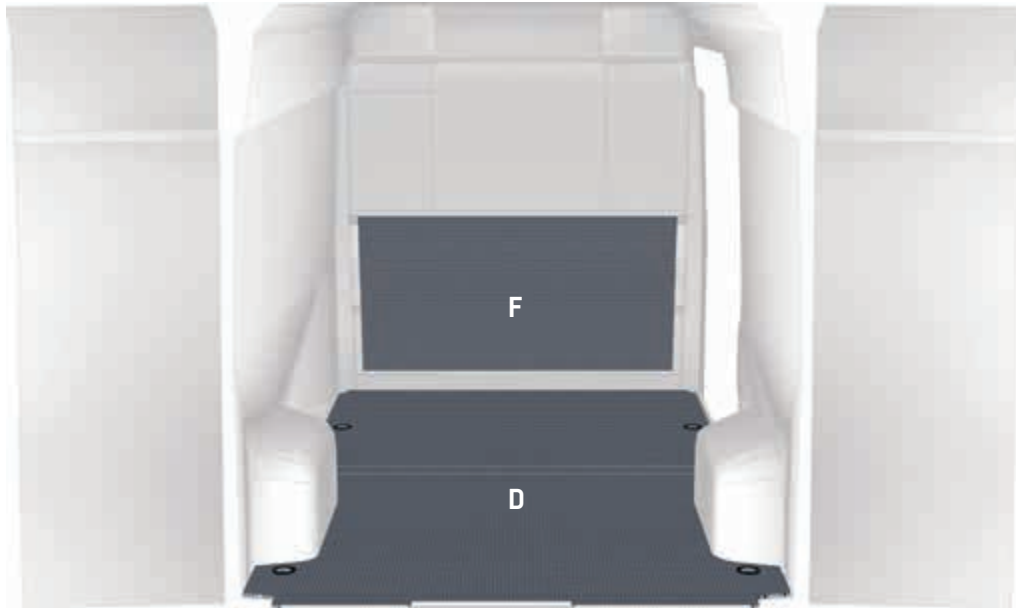

**WOOD FLOOR - D**

- Bodenplatte aus Multiplex mit Phenolbeschichtung, Stärke 9/12 mm, für das Originalverankerungssystem des Fahrzeugs vorgebohrt.
- 9/12 mm thick wooden flooring with phenolic coating set for the vehicle original anchoring system

**WOOD FLOOR - F**

- Kabinenrückwandplatte aus Multiplex mit Phenolbeschichtung, Stärke 12 mm
- 12 mm thick wooden bulkhead panel with phenolic coating

FAHRZEUG VEHICLE	BODENPLATTE 9 mm 9 mm FLOORING	BODENPLATTE 12 mm 12 mm FLOORING	RÜCKWANDPLATTE BULKHEAD
	D	D	F (1670x670x12 mm)
	ART.	ART.	ART.
Fahrzeugtyp - Model L1 · 3000 <sup>A</sup>	<b>F22 WF DA10D1 JO 1S</b> 28,45 kg	<b>F22 WF DA10T1 JO 1S</b> 35,55 kg	<b>F22 WF DAWBT1 JO 1S</b> 9,18 kg
Fahrzeugtyp - Model L2 · 3520 <sup>A</sup>	<b>F22 WF DA20D1 JO 1S</b> 35,12 kg	<b>F22 WF DA20T1 JO 1S</b> 43,80 kg	<b>F22 WF DAWBT1 JO 1S</b> 9,18 kg
Fahrzeugtyp - Model L2 · 3520 <sup>B</sup>	<b>F22 WF DA20D1 SO 1S</b> 35,03 kg	<b>F22 WF DA20T1 SO 1S</b> 43,71 kg	<b>F22 WF DAWBT1 JO 1S</b> 9,18 kg
Fahrzeugtyp - Model L2L · 3520L <sup>A</sup>	<b>F22 WF DA2LD1 JO 1S</b> 39,80 kg	<b>F22 WF DA2LT1 JO 1S</b> 49,69 kg	<b>F22 WF DAWBT1 JO 1S</b> 9,18 kg
Fahrzeugtyp - Model L2L · 3520L <sup>B</sup>	<b>F22 WF DA2LD1 SO 1S</b> 38,63 kg	<b>F22 WF DA2LT1 SO 1S</b> 49,68 kg	<b>F22 WF DAWBT1 JO 1S</b> 9,18 kg
Fahrzeugtyp - Model L3 · 4100 <sup>A</sup>	<b>F22 WF DA30D1 JO 1S</b> 54,25 kg	<b>F22 WF DA30T1 JO 1S</b> 67,07 kg	<b>F22 WF DAWBT1 JO 1S</b> 9,18 kg
Fahrzeugtyp - Model L3 · 4100 <sup>B</sup>	<b>F22 WF DA30D1 SO 1S</b> 52,55 kg	<b>F22 WF DA30T1 SO 1S</b> 64,93 kg	<b>F22 WF DAWBT1 JO 1S</b> 9,18 kg
Fahrzeugtyp - Model L3L · 4100L <sup>B</sup>	<b>F22 WF DA3LD1 SO 1S</b> 56,63 kg	<b>F22 WF DA3LT1 SO 1S</b> 70,68 kg	<b>F22 WF DAWBT1 JO 1S</b> 9,18 kg



<sup>A</sup> Heckantrieb, Einzelbereifung - Rear-wheel drive, single wheels  
<sup>B</sup> Heckantrieb, Zwillingsbereifung - Rear-wheel drive, twin wheels







- Seitenverkleidungen für Fahrzeug mit rechter Schiebetür und Seitenwänden aus Vollblech.
- Linings for right side door vehicle with metal sheet sidewalls.

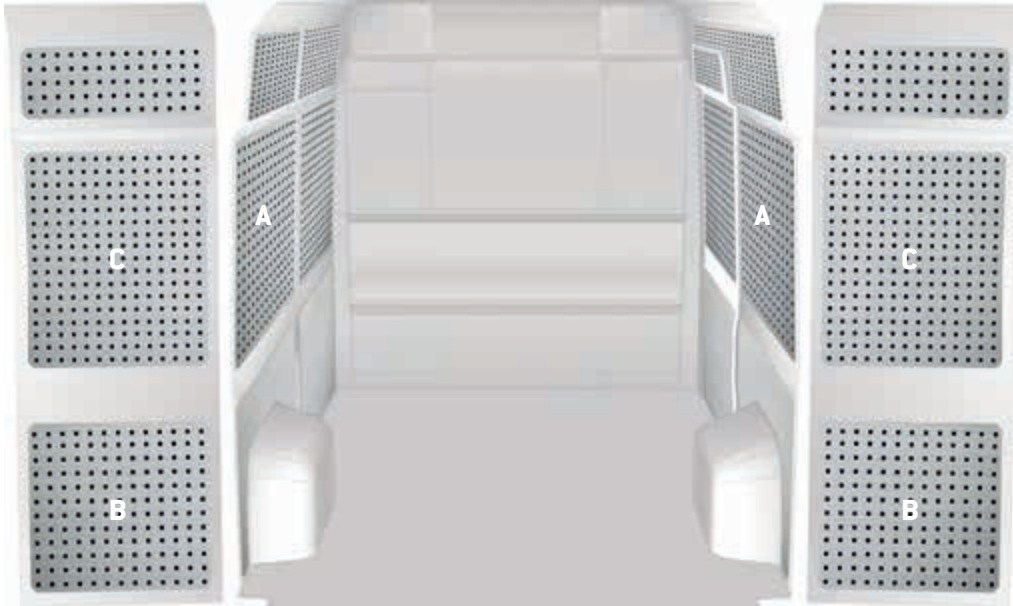
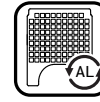

**ALUMINIUM PANEL - A**

- Seitenverkleidungen aus Aluminium für:
  - linke Seitenwand
  - rechte Seitenwand und Schiebetür
- Aluminium side panelling for:
  - LH sidewall
  - RH sidewall and sliding door

**ALUMINIUM PANEL - B**

- Seitenverkleidungen aus Aluminium für:
  - unteren Teil der Heckflügeltüren
- Aluminium side panelling for:
  - lower part of rear hinged doors

**ALUMINIUM PANEL - C**

- Seitenverkleidungen aus Aluminium für:
  - oberen Teil der Heckflügeltüren
- Aluminium side panelling for:
  - upper part of rear hinged doors

**FAHRZEUG  
VEHICLE**

**SEITENVERKLEIDUNG AUS ALUMINIUM  
ALUMINIUM SIDE PANNELLING**

	A+B	C
	ART.	ART.
Fahrzeugtyp - Model L1 H1 · 3000 H1 <sup>A</sup>	F22 AP DA10H1 J0 00 22,46 kg	F22 AP DADRH1 J0 00 4,38 kg
Fahrzeugtyp - Model L2 H1 · 3520 H1 <sup>A</sup>	F22 AP DA20H1 J0 00 27,99 kg	F22 AP DADRH1 J0 00 4,38 kg
Fahrzeugtyp - Model L2 H2 · 3520 H2 <sup>A</sup>	F22 AP DA20H2 J0 00 34,37 kg	F22 AP DADRH2 J0 00 4,67 kg
Fahrzeugtyp - Model L2L H2 · 3520L H2 <sup>A</sup>	F22 AP DA2LH2 J0 00 39,04 kg	F22 AP DADRH2 J0 00 4,67 kg
Fahrzeugtyp - Model L2L H3 · 3520L H3 <sup>A</sup>	F22 AP DA2LH3 J0 00 44,93 kg	F22 AP DADRH3 J0 00 6,52 kg
Fahrzeugtyp - Model L3 H2 · 4100 H2 <sup>A</sup>	F22 AP DA30H2 J0 00 51,77 kg	F22 AP DADRH2 J0 00 4,67 kg
Fahrzeugtyp - Model L3 H3 · 4100 H3 <sup>A</sup>	F22 AP DA30H3 J0 00 60,10 kg	F22 AP DADRH3 J0 00 6,52 kg
Fahrzeugtyp - Model L3L H2 · 4100L H2 <sup>B</sup>	F22 AP DA3LH2 S0 00 56,72 kg	F22 AP DADRH2 J0 00 4,67 kg
Fahrzeugtyp - Model L3L H3 · 4100L H3 <sup>B</sup>	F22 AP DA3LH3 S0 00 65,31 kg	F22 AP DADRH3 J0 00 6,52 kg



<sup>A</sup> Heckantrieb, Einzelbereifung  
Rear-wheel drive, single wheels

<sup>B</sup> Heckantrieb, Zwillingsbereifung  
Rear-wheel drive, twin wheels

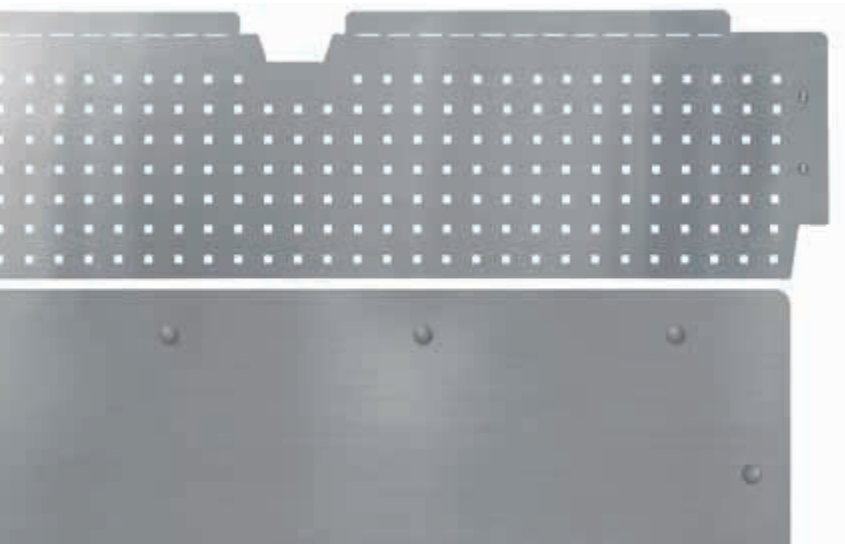



- Bodenplatte für Fahrzeug mit rechter Schiebetür und Seitenwänden aus Vollblech.
- Flooring for right side door vehicle with metal sheet sidewalls.

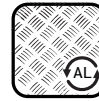

**ALUMINIUM FLOOR - D**

- Bodenplatte aus 9 mm dickem Holz mit 2 mm dicker Aluminium-Riffblechverkleidung und Vorbereitung für die Originalzurrpunkte des Fahrzeuges
- Aluminium flooring, 9 mm thickness, coated with aluminium diamond plate 2 mm thick and shaped to fit around the vehicle's original anchor points

FAHRZEUG VEHICLE	BODENPLATTE AUS ALUMINIUM (Holz + Aluminium) ALUMINIUM FLOORING (Wood + Aluminium)
	D
	ART.
Fahrzeugtyp - Model L1 · 3000 <sup>A</sup>	<b>F22 AF DA10A1 JO 00 + F22 AF DA10B1 JO 00</b> 31,76 kg + 32,68 kg
Fahrzeugtyp - Model L2 · 3520 <sup>A</sup>	<b>F22 AF DA20A1 JO 00 + F22 AF DA20B1 JO 00</b> 37,70 kg + 39,01 kg
Fahrzeugtyp - Model L2 · 3520 <sup>B</sup>	<b>F22 AF DA20A1 SO 00 + F22 AF DA20B1 SO 00</b> 36,05 kg + 37,37 kg
Fahrzeugtyp - Model L2L · 3520L <sup>A</sup>	<b>F22 AF DA2LA1 JO 00 + F22 AF DA2LB1 JO 00</b> 42,20 kg + 43,46 kg
Fahrzeugtyp - Model L2L · 3520L <sup>B</sup>	<b>F22 AF DA2LA1 SO 00 + F22 AF DA2LB1 SO 00</b> 41,60 kg + 43,50 kg
Fahrzeugtyp - Model L3 · 4100 <sup>A</sup>	<b>F22 AF DA30A1 JO 00 + F22 AF DA30B1 JO 00</b> 55,40 kg + 56,71 kg
Fahrzeugtyp - Model L3 · 4100 <sup>B</sup>	<b>F22 AF DA30A1 SO 00 + F22 AF DA30B1 SO 00</b> 53,75 kg + 55,23 kg
Fahrzeugtyp - Model L3L · 4100L <sup>A</sup>	<b>F22 AF DA3LA1 JO 00 + F22 AF DA3LB1 JO 00</b> 61,15 kg + 61,31 kg
Fahrzeugtyp - Model L3L · 4100L <sup>B</sup>	<b>F22 AF DA3LA1 SO 00 + F22 AF DA3LB1 SO 00</b> 57,83 kg + 59,83 kg

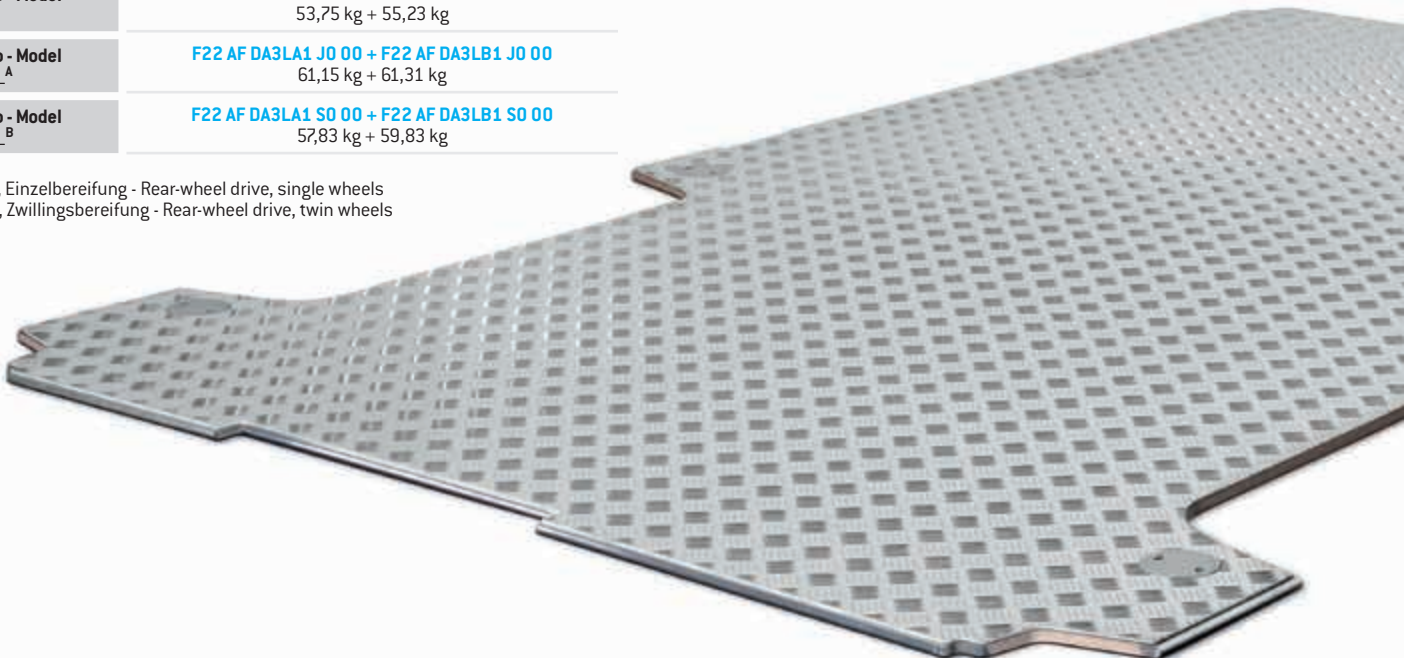
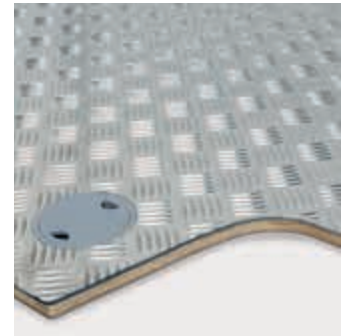

<sup>A</sup> Heckantrieb, Einzelbereifung - Rear-wheel drive, single wheels  
<sup>B</sup> Heckantrieb, Zwillingsbereifung - Rear-wheel drive, twin wheels





- Bodenplatte für Fahrzeug mit rechter Schiebetür und Seitenwänden aus Vollblech.
- Flooring for right side door vehicle with metal sheet sidewalls.

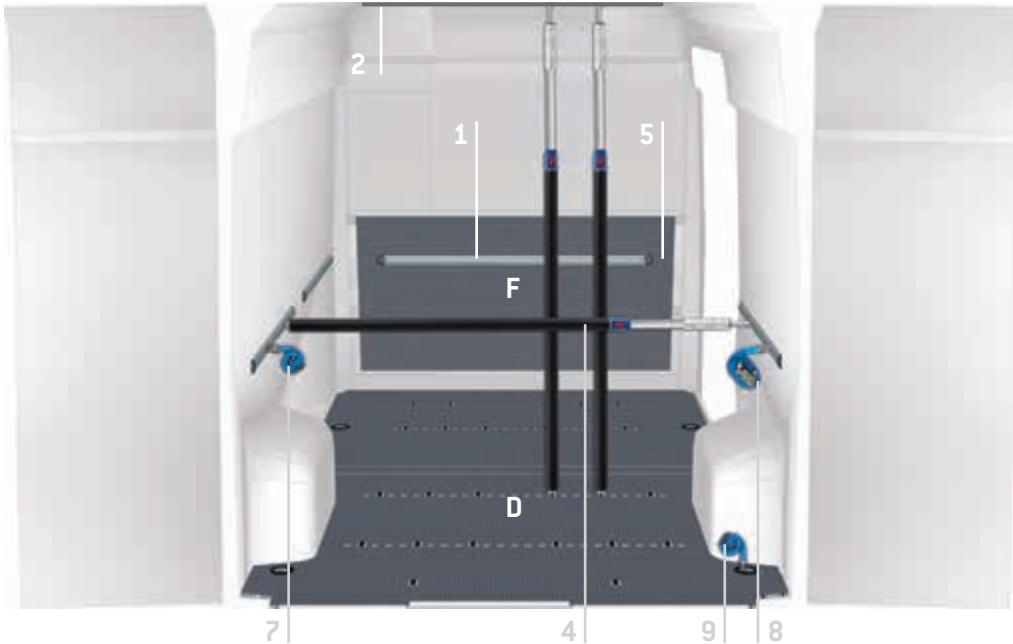

SAFETY FLOOR - D

- Bodenplatte 9 mm aus phenolbeschichtetem Holz mit zusätzlichem Einzelzurrpunktensystem.
- 9 mm phenol faced plywood flooring with additional lashing points

WOOD FLOOR - F

- Kabinenrückwandplatte aus Multiplex mit Phenolbeschichtung, Stärke 12 mm
- 12 mm thick wooden bulkhead panel with phenolic coating

FAHRZEUG VEHICLE	BODENPLATTE 9 mm FLOORING 9 mm	RÜCKWANDPLATTE BULKHEAD
	D	F [1670x670x12 mm]
	ART.	ART.
Fahrzeugtyp - Model L2 · 3520 <sup>A</sup>	F22 SF DA20G1 J0 1S 38,22 kg	F22 WF DAWBT1 J0 1S 9,18 kg
Fahrzeugtyp - Model L2 · 3520 <sup>B</sup>	F22 SF DA20G1 S0 1S 38,08 kg	F22 WF DAWBT1 J0 1S 9,18 kg
Fahrzeugtyp - Model L2L · 3520L <sup>A</sup>	F22 SF DA2LG1 J0 1S 43,62 kg	F22 WF DAWBT1 J0 1S 9,18 kg
Fahrzeugtyp - Model L2L · 3520L <sup>B</sup>	F22 SF DA2LG1 S0 1S 43,48 kg	F22 WF DAWBT1 J0 1S 9,18 kg
Fahrzeugtyp - Model L3 · 4100 <sup>A</sup>	F22 SF DA30G1 J0 1S 58,14 kg	F22 WF DAWBT1 J0 1S 9,18 kg
Fahrzeugtyp - Model L3 · 4100 <sup>B</sup>	F22 SF DA30G1 S0 1S 58,14 kg	F22 WF DAWBT1 J0 1S 9,18 kg

<sup>A</sup> Heckantrieb, Einzelbereifung - Rear-wheel drive, single wheels  
<sup>B</sup> Heckantrieb, Zwillingsbereifung - Rear-wheel drive, twin wheels

⚠ Die Bodenplatte muss auf den Fahrzeugboden aufgeklebt sein.  
 The floor must be glued to the vehicle

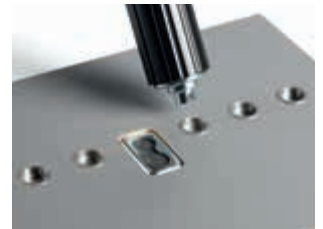

- Silikonklebstoff für Bodenplatten.
- Silicone glue for flooring.

ART.

F22 VT V22585 00 08

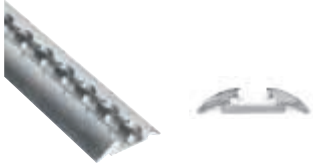
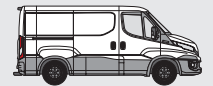

1

- Horizontale Aluschiene.
- Horizontal aluminium bar.

ART. **F22 FC V18029 05 00** L. 500 mm  
**F22 FC V18029 10 00** L. 1000 mm  
**F22 FC V18029 15 00** L. 1500 mm  
**F22 FC V18029 20 00** L. 2000 mm  
**F22 FC V18029 25 00** L. 2500 mm

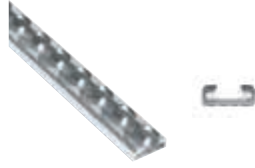

2

- Horizontale Aluschiene.
- Horizontal aluminium bar.

ART. **F22 FC V18025 05 00** L. 500 mm  
**F22 FC V18025 10 00** L. 1000 mm  
**F22 FC V18025 15 00** L. 1500 mm  
**F22 FC V18025 20 00** L. 2000 mm



KASTENWAGEN - PANEL VAN  
**IVECO DAILY**

**FC**



5

- Endstück aus Kunststoff für Aluschiene Serie V18029.
- Plastic end cap for bar series V18029.

ART. **F22 FC V22106 00 00**



10

- Endstück aus Kunststoff für Aluschiene Serie V18025.
- Plastic end cap for bar series V18025.

ART. **F22 FC V23389 00 00**

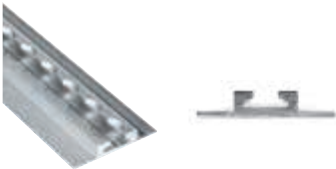

3

- Horizontale Aluschiene.
- Horizontal aluminium bar.

ART. **F22 FC V18030 10 00** L. 1000 mm  
**F22 FC V18030 15 00** L. 1500 mm  
**F22 FC V18030 20 00** L. 2000 mm  
**F22 FC V18030 25 00** L. 2500 mm  
**F22 FC V18030 30 00** L. 3000 mm



4

- Teleskopische Spannstange.
- Telescopic load restraining bar.

ART. **F22 FC V22149 00 00** L. 650-900 mm  
**F22 FC V22734 00 00** L. 850-1100 mm  
**F22 FC V22735 00 00** L. 1050-1300 mm  
**F22 FC V22131 00 00** L. 1250-1750 mm  
**F22 FC V22017 00 00** L. 1550-2050 mm  
**F22 FC V22086 00 00** L. 2000-2500 mm



- Beispiel von Ladungssicherungskoffer-kit.
- Example of tool case for load securing.



6

- Zurring.
- Ring stud fitting.

ART. **F22 FC V22582 00 00**



7

- Zurring mit Hebelspannschloss 2500+500.
- Load restraining belt with clamp 2500+500.

ART. **F22 FC V22136 00 00**



**F22 SB BOX080 00 01**  
**1 ART.**  
 B=440 T=350 H=80 mm  
 W=440 D=350 H=80 mm



**F22 SB CPV080 00 01**  
**1 ART.**



**F22 SB YELLOW 63 05**  
**1 ART. YELLOW**



**F22 FC V22582 00 00**  
**4 ART.**



**F22 FC V22136 00 00**  
**2 ART.**



8

- Zurring mit Ratschenschloss 2500+500.
- Load restraining belt with ratchet 2500+500.

ART. **F22 FC V22124 00 00**



9

- Zurring mit Ratschenschloss 4500+500.
- Load restraining belt with ratchet 4500+500.

ART. **F22 FC V22148 00 00**



**F22 FC V22124 00 00**  
**2 ART.**



**F22 FC V22148 00 00**  
**2 ART.**





# BESTANDTEILELISTE SEITENWANDVERKLEIDUNGEN - LININGS LEGEND

IVECO DAILY  
KASTENWAGEN - PANEL VAN

HP  
HONEYCOMB  
PANEL

- Für Fahrzeug mit rechter Schiebetür und Seitenwänden aus Vollblech.
- For right side door vehicle with metal sheet sidewalls.

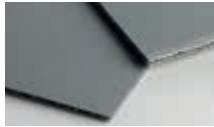

<sup>A</sup> Heckantrieb, Einzelbereifung  
Rear-wheel drive, single wheels

<sup>B</sup> Heckantrieb, Zwillingsbereifung  
Rear-wheel drive, twin wheels

Fahrzeugtyp - Model  
L1 H1 - 3000 H1<sup>A</sup>

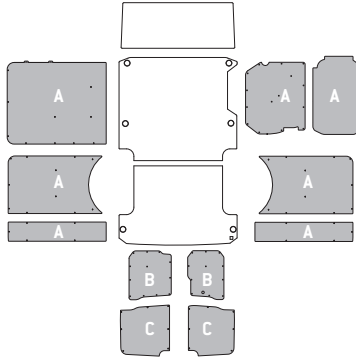

Fahrzeugtyp - Model  
L2 H1 - 3520 H1<sup>A</sup>

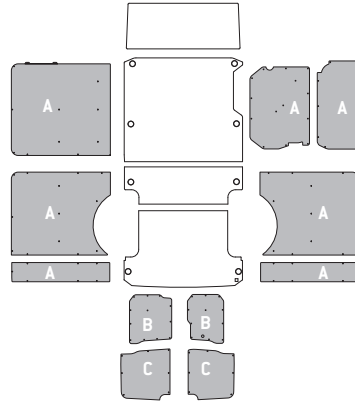

Fahrzeugtyp - Model  
L2 H2 - 3520 H2<sup>A</sup>

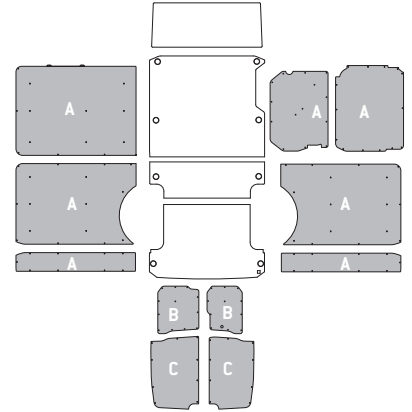

Fahrzeugtyp - Model  
L2L H2 - 3520L H2<sup>A</sup>

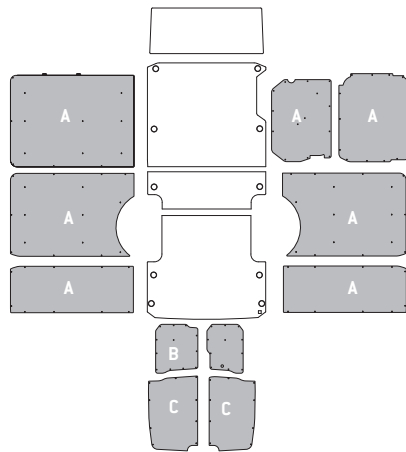

Fahrzeugtyp - Model  
L2L H3 - 3520L H3<sup>A</sup>

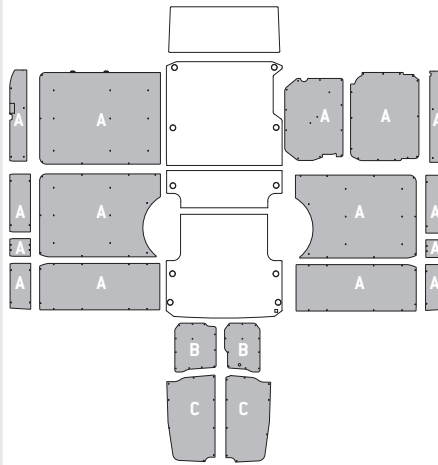

Fahrzeugtyp - Model  
L3 H2 - 4100 H2<sup>A</sup>

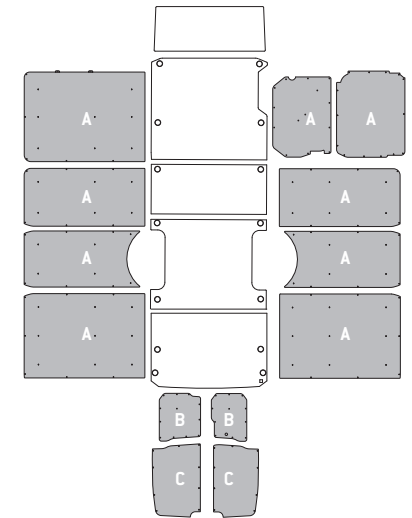

Fahrzeugtyp - Model  
L3 H3 - 4100 H3<sup>A</sup>

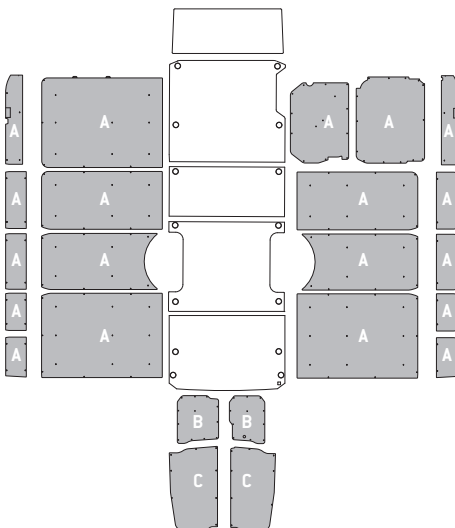

Fahrzeugtyp - Model  
L3L H2 - 4100L H2<sup>B</sup>

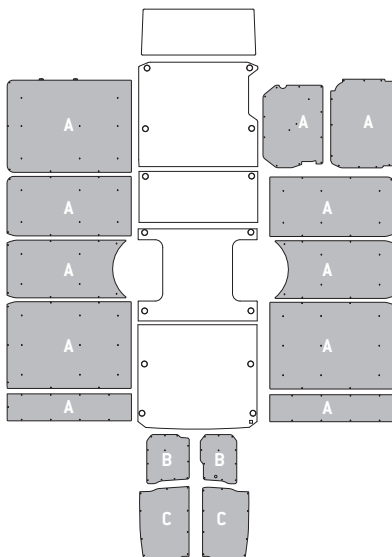

Fahrzeugtyp - Model  
L3L H3 - 4100L H3<sup>B</sup>

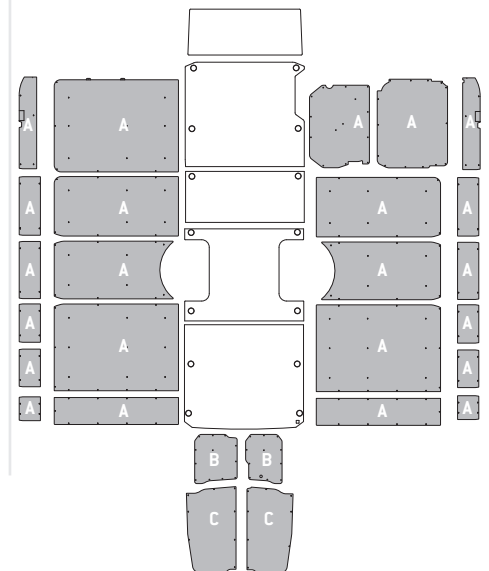

# BESTANDTEILELISTE BODENPLATTE - FLOORING LEGEND

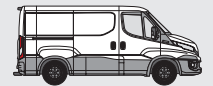

- Für Fahrzeug mit rechter Schiebetür und Seitenwänden aus Vollblech.
- For right side door vehicle with metal sheet sidewalls.

Fahrzeugtyp - Model L1 · 3000 <sup>A</sup>	Fahrzeugtyp - Model L2 · 3520 <sup>A</sup>	Fahrzeugtyp - Model L2 · 3520 <sup>B</sup>	Fahrzeugtyp - Model L2L · 3520L <sup>A</sup>	Fahrzeugtyp - Model L2L · 3520L <sup>B</sup>	Fahrzeugtyp - Model L3 · 4100 <sup>A</sup>	Fahrzeugtyp - Model L3 · 4100 <sup>B</sup>
<b>Fahrzeugtyp - Model L3L · 4100L<sup>B</sup></b>						
	<ul style="list-style-type: none"> <li>• Kabinenrückwandplatte.</li> <li>• Bulkhead panel</li> </ul>					
	<ul style="list-style-type: none"> <li><sup>A</sup> Heckantrieb, Einzelbereifung - Rear-wheel drive, single wheels</li> <li><sup>B</sup> Heckantrieb, Zwillingsbereifung - Rear-wheel drive, twin wheels</li> </ul>					

KASTENWAGEN - PANEL VAN  
IVECO DAILY

WOOD  
FLOOR

WF

- Für Fahrzeug mit rechter Schiebetür und Seitenwänden aus Vollblech.
- For right side door vehicle with metal sheet sidewalls.

Fahrzeugtyp - Model L2 · 3520 <sup>A</sup>	Fahrzeugtyp - Model L2 · 3520 <sup>B</sup>	Fahrzeugtyp - Model L2L · 3520L <sup>A</sup>	Fahrzeugtyp - Model L2L · 3520L <sup>B</sup>	Fahrzeugtyp - Model L3 · 4100 <sup>A</sup>	Fahrzeugtyp - Model L3 · 4100 <sup>B</sup>

- <sup>A</sup> Heckantrieb, Einzelbereifung - Rear-wheel drive, single wheels
- <sup>B</sup> Heckantrieb, Zwillingsbereifung - Rear-wheel drive, twin wheels



3520<sup>A</sup> · 3520L<sup>A</sup> · 4100<sup>A</sup> · 4100<sup>B</sup>

- Jede Reihe von Verankerungspunkten für jede Bodenplatte besteht aus 6 "Airline" Einzelzurrpunkten und 16 Fixierspunkten für „Airline“ Sperrstangen.

- In each flooring, each lashing row is composed of 6 "Airline" lashing points and 16 fixing points for "Airline" shoring bars



3520<sup>B</sup> · 3520L<sup>B</sup>

- Jede Reihe von Verankerungspunkten für jede Bodenplatte besteht aus 6 "Airline" Einzelzurrpunkten und 16/12 Fixierspunkten für „Airline“ Sperrstangen.

- In each flooring, each lashing row is composed of 6 "Airline" lashing points and 16/12 fixing points for "Airline" shoring bars

SAFETY  
FLOOR

SF

- Für Fahrzeug mit rechter Schiebetür und Seitenwänden aus Vollblech.
- For right side door vehicle with metal sheet sidewalls.

Fahrzeugtyp - Model L1 · 3000 <sup>A</sup>	Fahrzeugtyp - Model L2 · 3520 <sup>A</sup>	Fahrzeugtyp - Model L2 · 3520 <sup>B</sup>	Fahrzeugtyp - Model L2L · 3520L <sup>A</sup>	Fahrzeugtyp - Model L2L · 3520L <sup>B</sup>	Fahrzeugtyp - Model L3 · 4100 <sup>A</sup>	Fahrzeugtyp - Model L3 · 4100 <sup>B</sup>
<b>Fahrzeugtyp - Model L3L · 4100L<sup>A</sup></b>	<b>Fahrzeugtyp - Model L3L · 4100L<sup>B</sup></b>					
	<ul style="list-style-type: none"> <li><sup>A</sup> Heckantrieb, Einzelbereifung - Rear-wheel drive, single wheels</li> <li><sup>B</sup> Heckantrieb, Zwillingsbereifung - Rear-wheel drive, twin wheels</li> </ul>					

ALUMINIUM  
FLOOR

AF





## SAFETY



**Serienmäßig mit  
Ladungssicherung**

**Factory-fitted load  
securing**



Die Lösungen der **SAFETY Transportereinrichtungen** von Store Van erfüllen die Erfordernisse der neuen Ladungssicherungsbestimmungen. In die Module werden Strukturelemente eingebaut, die eine Nutzung der „Airline“ Festhaltesysteme wie Gurte, Netze und teleskopische Spannstangen erlauben. Dieses neue Niveau der **Einrichtungen für Nutzfahrzeuge** erleichtert das Verankern von mittelgroßen und kleinen Gegenständen, selbst wenn die Transporter-Bodenplatten nicht mit Verankerungssystemen ausgestattet sind, und garantiert dadurch die Ladungssicherung. Die „Airline“ Verankerungselemente des SAFETY-Niveaus erhöhen die Stabilität der Module ohne Gewichtszunahme, denn sie in der Struktur der Einrichtung integriert sind.

The Store Van **SAFETY equipment solution** meets the requirements of the new cargo restraint regulations. Our modules are integrated with structural elements where “Airline” anchoring fittings, such as belts, nets and telescopic bars can easily fit. This new equipment for commercial vehicles simplifies the securing of medium-sized or small parts, even if the floor panel of your van has no anchoring systems, to guarantee maximum load securing. The “Airline” anchoring fittings for SAFETY equipment improve the stability of modules with no weight increase, because they are built in the equipment structure.







## PROFESSIONAL

**Die perfekte  
Integration zwischen  
Fahrzeug und mobiler  
Werkstatteinrichtung**

**Perfect integration  
between vehicle and  
mobile workshop  
equipment**



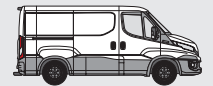

Die Transportereinrichtung **PROFESSIONAL** von Store Van ist perfekt im Fahrzeug integriert und eigens so entwickelt, dass sie die strukturellen und dynamischen Eigenschaften des Fahrzeugs hervorhebt. In den Modulen dieses neuen **Einrichtungsniveaus für Nutzfahrzeug**, z.B. in den Regalen für Transporter, sind für eine perfekte Befestigung der Ladung am Fahrzeugrahmen serienmäßig Elemente eingebaut, die „Airline“ Festhaltesysteme nutzen. Dank der neuen Bodenplatte SAFETY FLOOR stehen für die Ladungen vertikale und horizontale Festhaltesysteme zur Verfügung.

The Store Van **PROFESSIONAL equipment solution** is perfectly integrated in your vehicle and has been designed to enhance its structural and dynamic characteristics. The modules of this new **equipment for commercial vehicles**, such as shelving units for vans, are factory fitted with elements ensuring a perfect load anchoring to the chassis of your vehicle with „Airline“ anchoring systems.

Both vertical and horizontal load restraining elements can be installed in your van thanks to the new SAFETY FLOOR panel.







# MOBILE



**Nicht nur  
Fahrzeug,  
sondern auch  
Mobilität**

**All-out  
mobility**

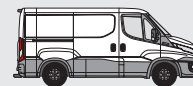

Die Lösung MOBILE ergänzt die Store Van Nutzfahrzeugeinrichtungen mit den Kleinteilekoffern der Serie STORE BOX 102 – 136 – 238 und den dazugehörigen Wagen, der den Benutzer der **mobilen Werkstatt** beim Transport der Waren und Ausrüstung vom Fahrzeug zur Arbeitsstelle unterstützt. Die neuen „Airline“ Verankerungselemente erhöhen die Stabilität des Moduls, ohne sein Gewicht zu beeinflussen. Auch in diesem Fall werden in den Regalen Elemente eingebaut, die eine Nutzung der „Airline“ Festhaltesysteme ermöglichen. Auch dank der Einführung der Bodenplatte SAFETY FLOOR können sowohl vertikale als auch horizontale Ladungssicherungssysteme gewählt werden.

The **MOBILE equipment solution** integrates Store Van fittings for commercial vehicles with small-parts cases, series STORE BOX 102 – 136 – 238, and trolleys by which **mobile workshop** users can easily carry their goods and tools from their van to the workplace.

The new “Airline” anchoring fittings improve the stability of modules with no weight increase. Here shelving units are integrated with elements where “Airline” anchoring systems can easily fit. Both vertical and horizontal load restraining elements can be installed in your van thanks to the new SAFETY FLOOR flooring panels.







3000 H1

Frontantrieb - Front wheel drive

IVECO DAILY  
KASTENWAGEN - PANEL VAN

SAFETY

L1 H1

SAFETY

FAHRZEUGEINRICHTUNGSBEISPIELE - FITTINGS EXAMPLES

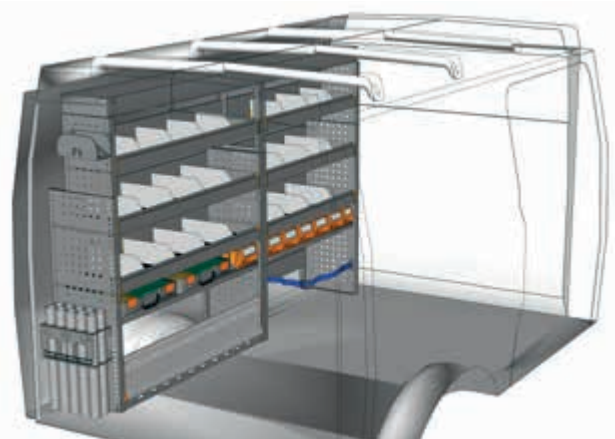

BEISPIEL - EXAMPLE

DA 2214 01\*

B=2241 T=365 H=1440 mm - W=2241 D=365 H=1440 mm

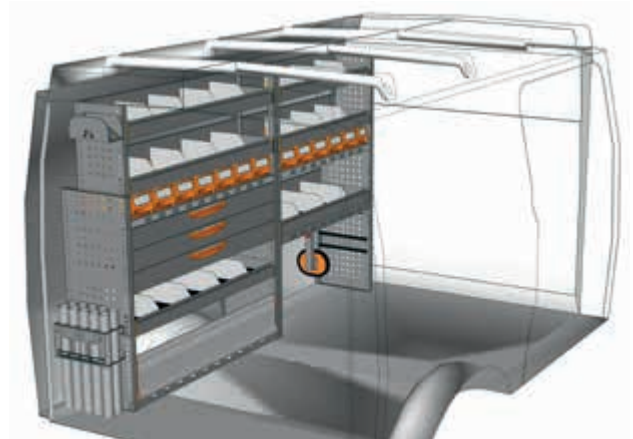
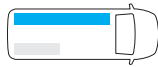

BEISPIEL - EXAMPLE

DA 2214 02\*

B=2241 T=365 H=1440 mm - W=2241 D=365 H=1440 mm

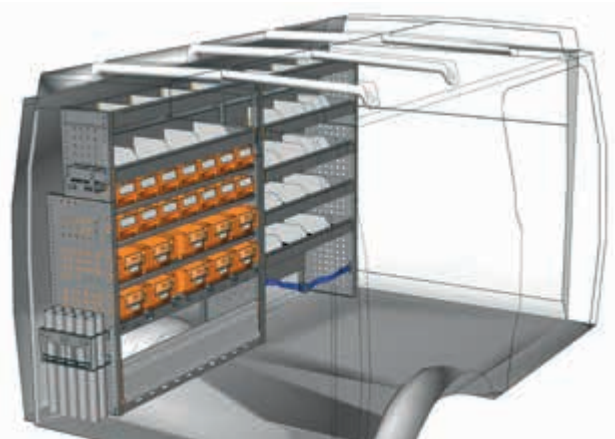

BEISPIEL - EXAMPLE

DA 2214 03\*

B=2241 T=365 H=1440 mm - W=2241 D=365 H=1440 mm

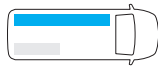

\* Einschließlich Befestigungs-Kit - Fixing kit included

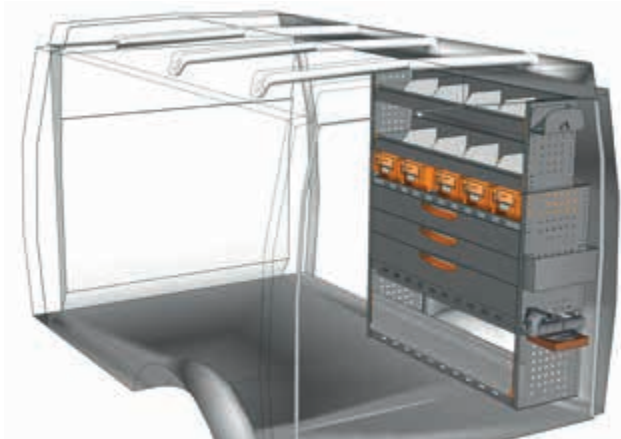

BEISPIEL - EXAMPLE

DA 1214 01\*

B=1225 T=365 H=1400 mm - W=1225 D=365 H=1400 mm

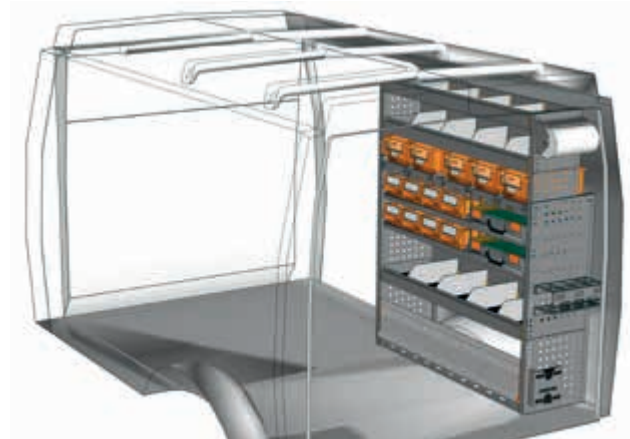

BEISPIEL - EXAMPLE

DA 1214 02\*

B=1225 T=365 H=1400 mm - W=1225 D=365 H=1400 mm

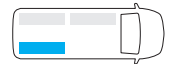

Ansicht von der Schiebetür  
View from side door



BEISPIEL - EXAMPLE

DA 1214 03\*

B=1225 T=365 H=1400 mm - W=1225 D=365 H=1400 mm



**Haben Sie Ihre Einrichtung nicht gefunden?**  
**Verlassen Sie sich auf die Profis für Fahrzeugeinrichtungen.**

Auf der Rückseite dieses Katalogs finden Sie die nächstgelegene StoreVan Niederlassung. Besuchen Sie unsere Web-Seite.

**Didn't find the equipment you're looking for?**  
**Leave it to our experts.**

See the back of this catalogue and contact the nearest StoreVan point or visit our website.





# L1 H1 PROFESSIONAL

FAHRZEUGEINRICHTUNGSBEISPIELE - FITTINGS EXAMPLES

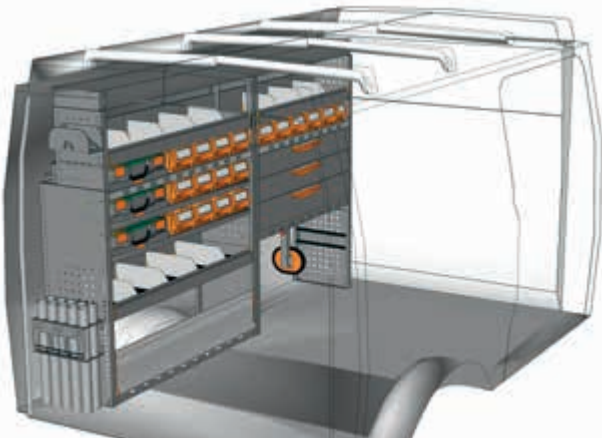

BEISPIEL - EXAMPLE

DA 2214 P1\*

B=2241 T=365 H=1440 mm - W=2241 D=365 H=1440 mm

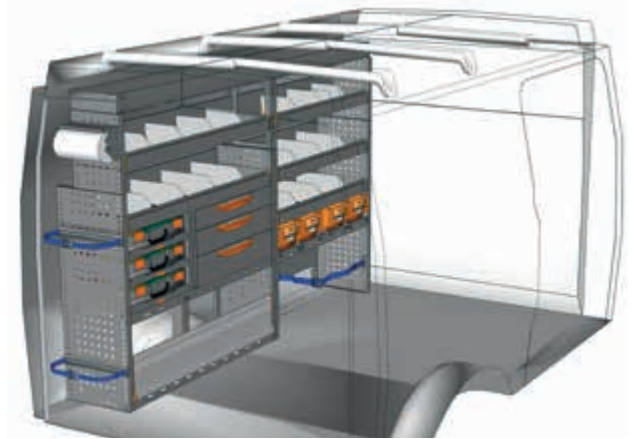
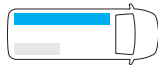

BEISPIEL - EXAMPLE

DA 2214 P2\*

B=2241 T=365 H=1440 mm - W=2241 D=365 H=1440 mm

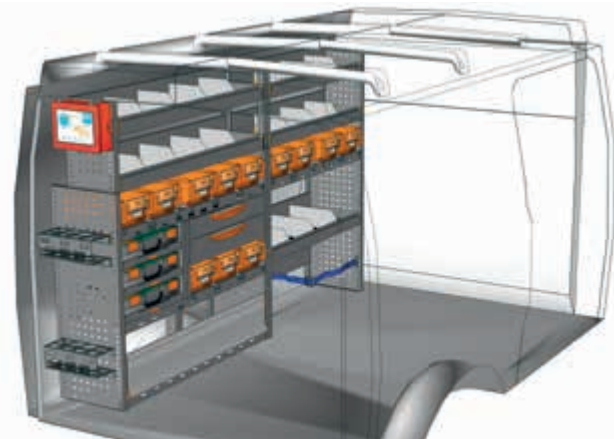
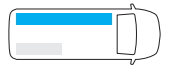

BEISPIEL - EXAMPLE

DA 2214 P3\*

B=2241 T=365 H=1440 mm - W=2241 D=365 H=1440 mm

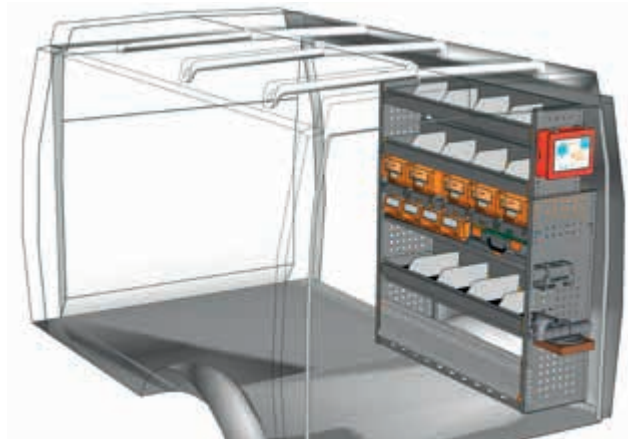
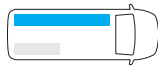

BEISPIEL - EXAMPLE

DA 1214 P1\*

B=1225 T=365 H=1400 mm - W=1225 D=365 H=1400 mm

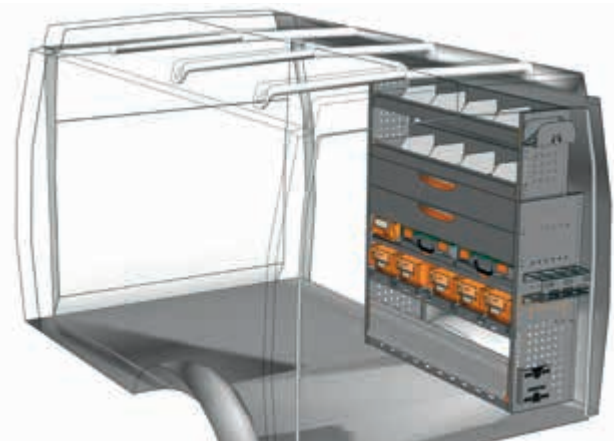

BEISPIEL - EXAMPLE

DA 1214 P2\*

B=1225 T=365 H=1400 mm - W=1225 D=365 H=1400 mm

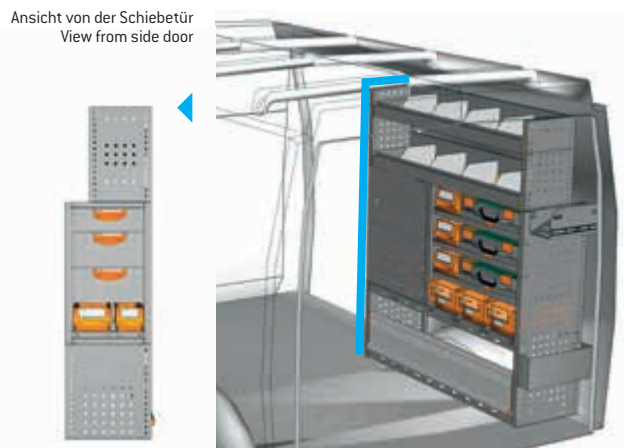

BEISPIEL - EXAMPLE

DA 1214 P3\*

B=1225 T=365 H=1400 mm - W=1225 D=365 H=1400 mm



\* Einschließlich Befestigungskit - Fixing kit included





FAHRZEUGEINRICHTUNGSBEISPIELE - FITTINGS EXAMPLES

MOBILE

L1 H1

KASTENWAGEN - PANEL VAN

MOBILE

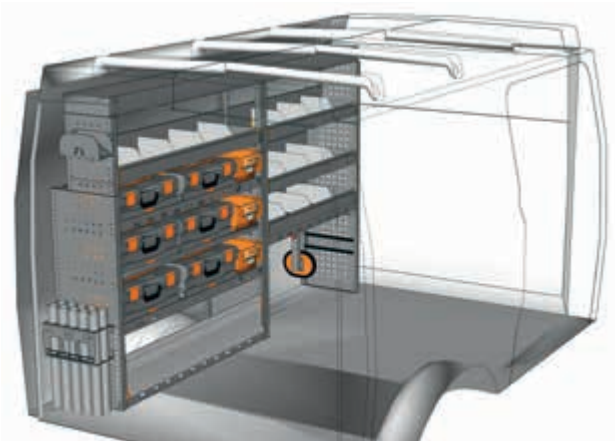

BEISPIEL - EXAMPLE

DA 2214 M1\*

B=2241 T=365 H=1440 mm - W=2241 D=365 H=1440 mm

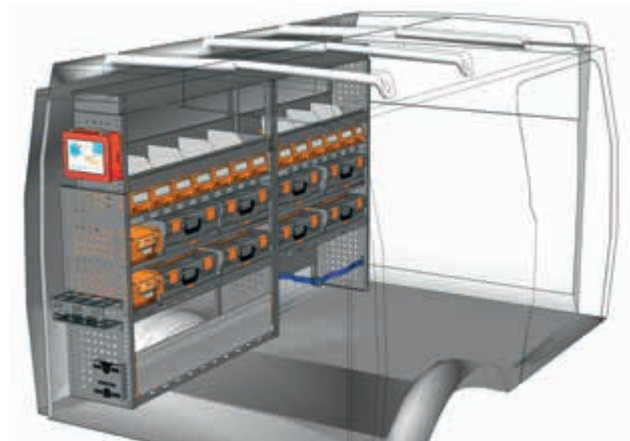
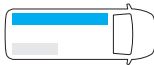

BEISPIEL - EXAMPLE

DA 2214 M2\*

B=2241 T=365 H=1440 mm - W=2241 D=365 H=1440 mm

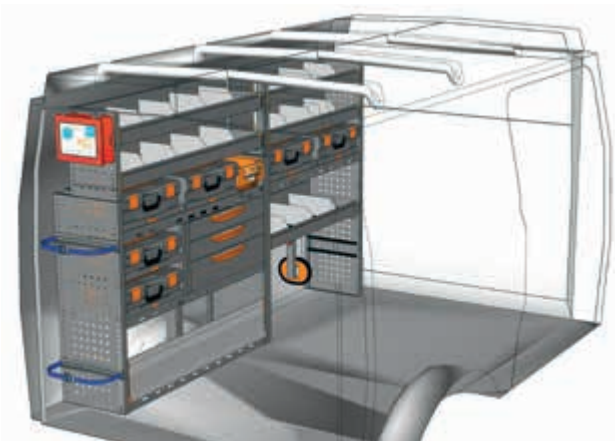
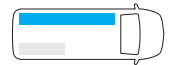

BEISPIEL - EXAMPLE

DA 2214 M3\*

B=2241 T=365 H=1440 mm - W=2241 D=365 H=1440 mm

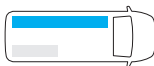

BEISPIEL - EXAMPLE

DA 1214 M1\*

B=1225 T=365 H=1400 mm - W=1225 D=365 H=1400 mm

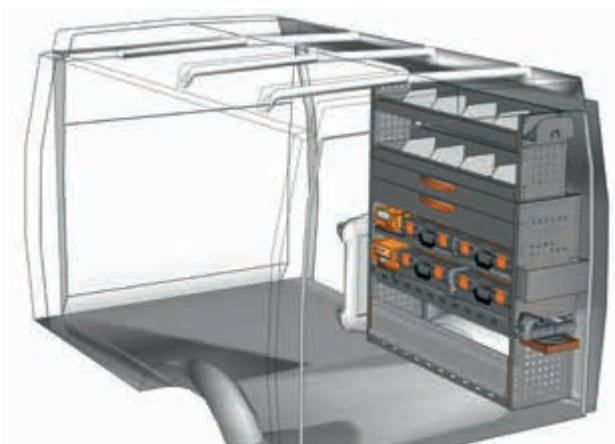
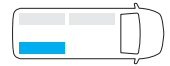

BEISPIEL - EXAMPLE

DA 1214 M2\*

B=1225 T=365 H=1400 mm - W=1225 D=365 H=1400 mm

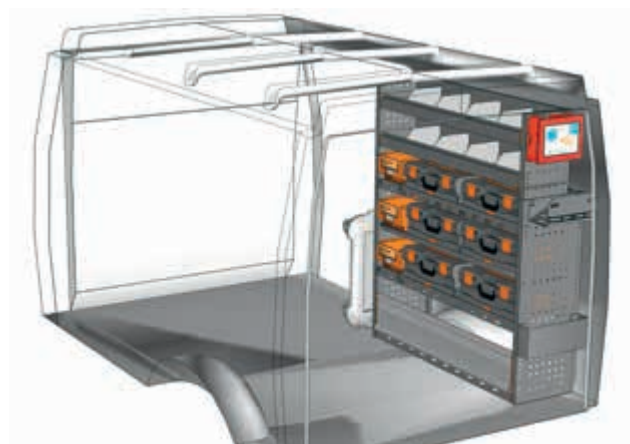
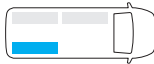

BEISPIEL - EXAMPLE

DA 1214 M3\*

B=1225 T=365 H=1400 mm - W=1225 D=365 H=1400 mm

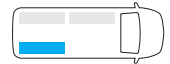

\* Einschließlich Befestigungskit - Fixing kit included

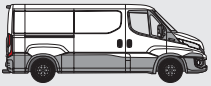

3520 H1

Frontantrieb - Front wheel drive

IVECO DAILY  
KASTENWAGEN - PANEL VAN

SAFETY

L2 H1

SAFETY

FAHRZEUGEINRICHTUNGSBEISPIELE - FITTINGS EXAMPLES

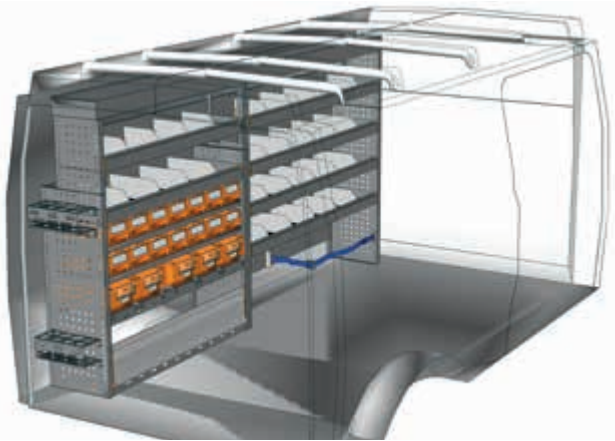

BEISPIEL - EXAMPLE

DA 2714 01\*

B=2749 T=365 H=1440 mm - W=2749 D=365 H=1440 mm

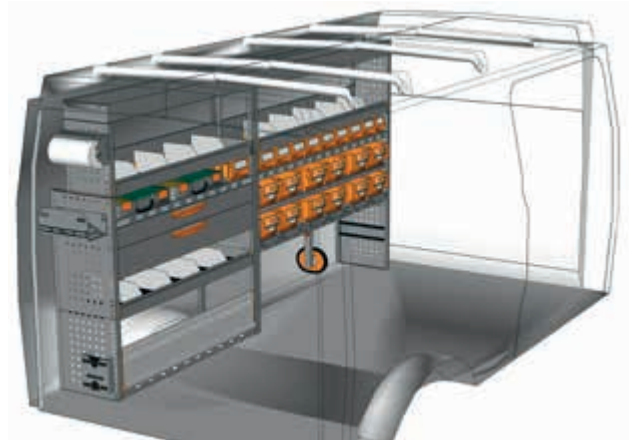
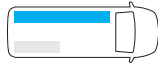

BEISPIEL - EXAMPLE

DA 2714 02\*

B=2749 T=365 H=1440 mm - W=2749 D=365 H=1440 mm

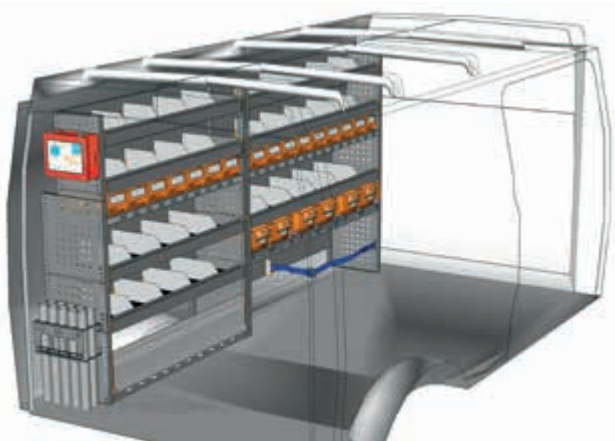
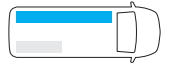

BEISPIEL - EXAMPLE

DA 2714 03\*

B=2749 T=365 H=1440 mm - W=2749 D=365 H=1440 mm

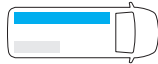

\* Einschließlich Befestigungskit - Fixing kit included



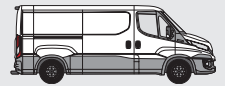

FAHRZEUGEINRICHTUNGSBEISPIELE - FITTINGS EXAMPLES

SAFETY

L2 H1

KASTENWAGEN - PANEL VAN  
IVECO DAILY

SAFETY

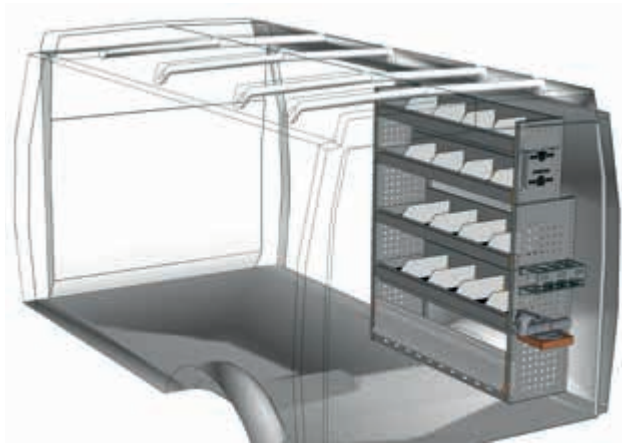

BEISPIEL - EXAMPLE

DA 1214 04\*

B=1225 T=365 H=1400 mm - W=1225 D=365 H=1400 mm

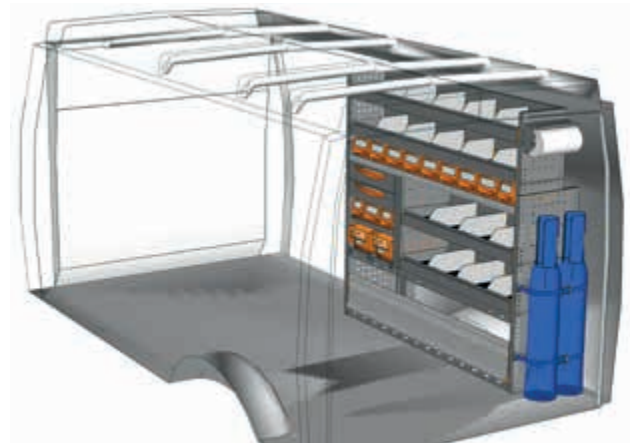
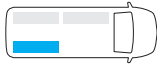

BEISPIEL - EXAMPLE

DA 1514 01\*

B=1524 T=365 H=1400 mm - W=1524 D=365 H=1400 mm

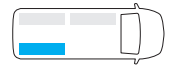

Ansicht von der Schiebetür  
View from side door

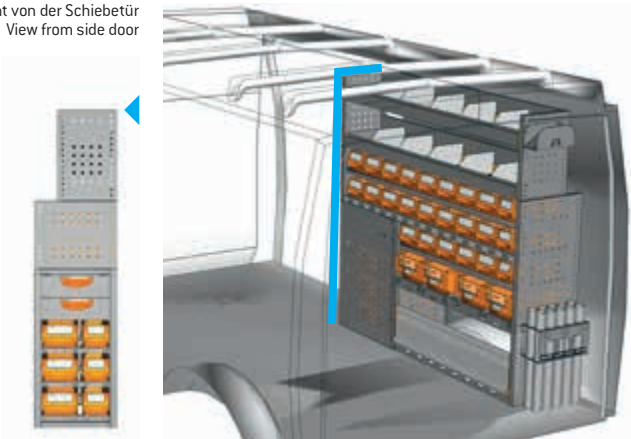

BEISPIEL - EXAMPLE

DA 1514 02\*

B=1524 T=365 H=1400 mm - W=1524 D=365 H=1400 mm



**Haben Sie Ihre Einrichtung nicht gefunden?**  
**Verlassen Sie sich auf die Profis für Fahrzeugeinrichtungen.**

Auf der Rückseite dieses Katalogs finden Sie die nächstgelegene StoreVan Niederlassung. Besuchen Sie unsere Web-Seite.

**Didn't find the equipment you're looking for?**  
**Leave it to our experts.**  
See the back of this catalogue and contact the nearest StoreVan point or visit our website.



\* Einschließlich Befestigungskit - Fixing kit included

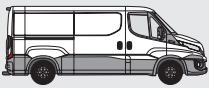

3520 H1

Frontantrieb - Front wheel drive

IVECO DAILY  
KASTENWAGEN - PANEL VAN

PROFESSIONAL

# L2 H1 PROFESSIONAL

FAHRZEUGEINRICHTUNGSBEISPIELE - FITTINGS EXAMPLES

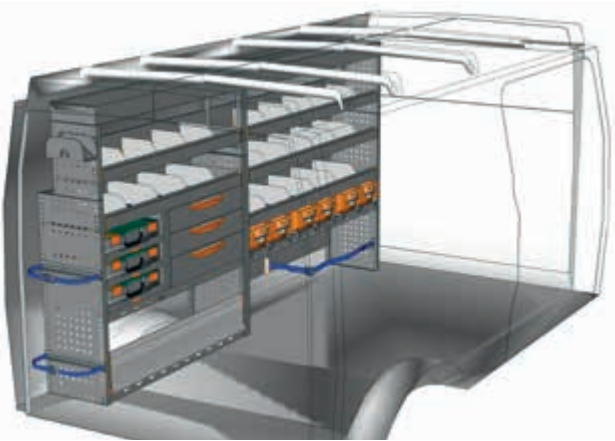

BEISPIEL - EXAMPLE

DA 2714 P1\*

B=2749 T=365 H=1440 mm - W=2749 D=365 H=1440 mm

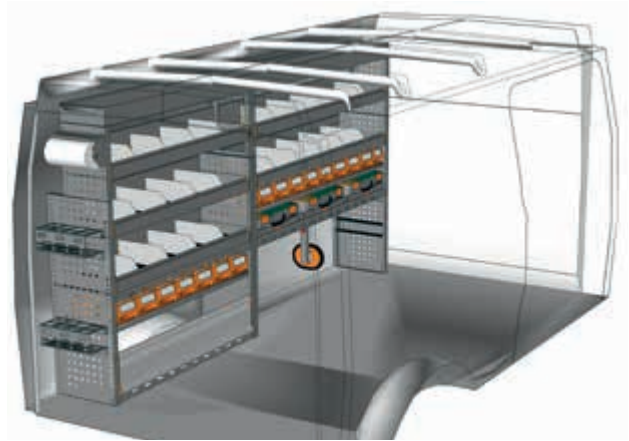
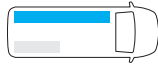

BEISPIEL - EXAMPLE

DA 2714 P2\*

B=2749 T=365 H=1440 mm - W=2749 D=365 H=1440 mm

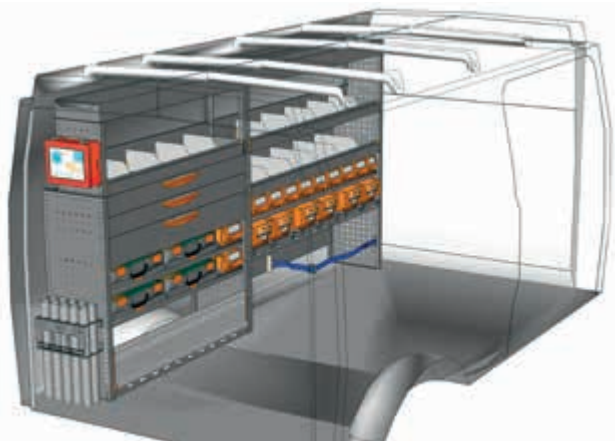
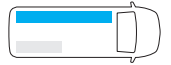

BEISPIEL - EXAMPLE

DA 2714 P3\*

B=2749 T=365 H=1440 mm - W=2749 D=365 H=1440 mm

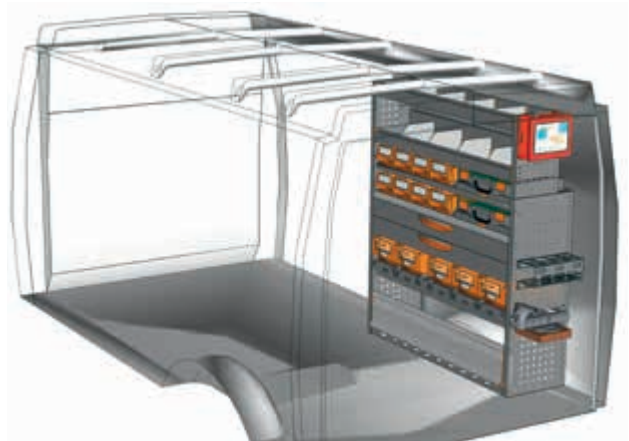
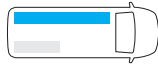

BEISPIEL - EXAMPLE

DA 1214 P4\*

B=1225 T=365 H=1400 mm - W=1225 D=365 H=1400 mm

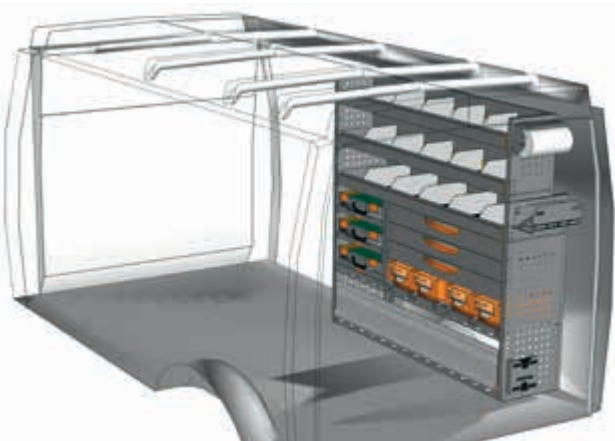
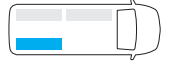

BEISPIEL - EXAMPLE

DA 1514 P1\*

B=1524 T=365 H=1400 mm - W=1524 D=365 H=1400 mm

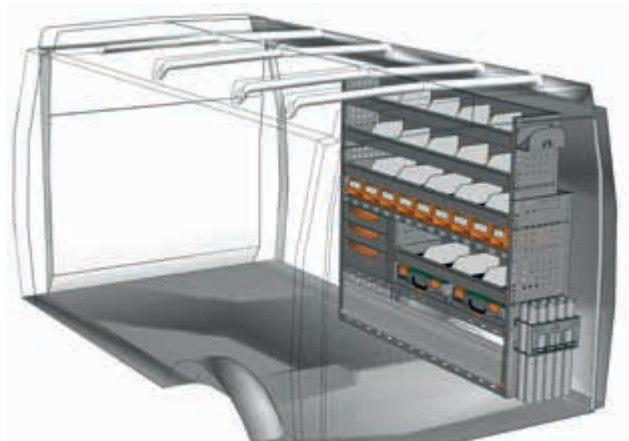
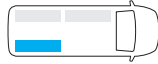

BEISPIEL - EXAMPLE

DA 1514 P2\*

B=1524 T=365 H=1400 mm - W=1524 D=365 H=1400 mm



\* Einschließlich Befestigungsset - Fixing kit included

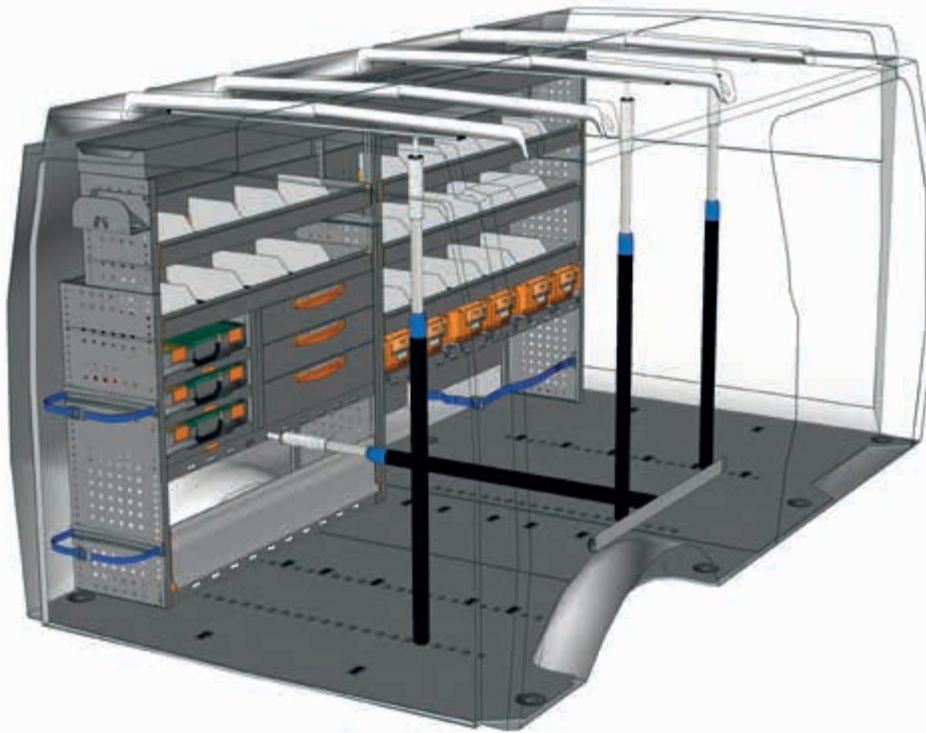
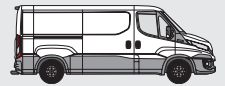

BEISPIEL - EXAMPLE

EXAMPLE DA L2H1 P1\*

- 1 x DA 2714 P1
- 1 x F22 SF DA20G1 J0 1S
- 4 x F22 FC V22131 00 00
- 1 x F22 FC V18029 10 00
- 2 x F22 FC V22106 00 00
- 3 x F22 FC V18025 10 00

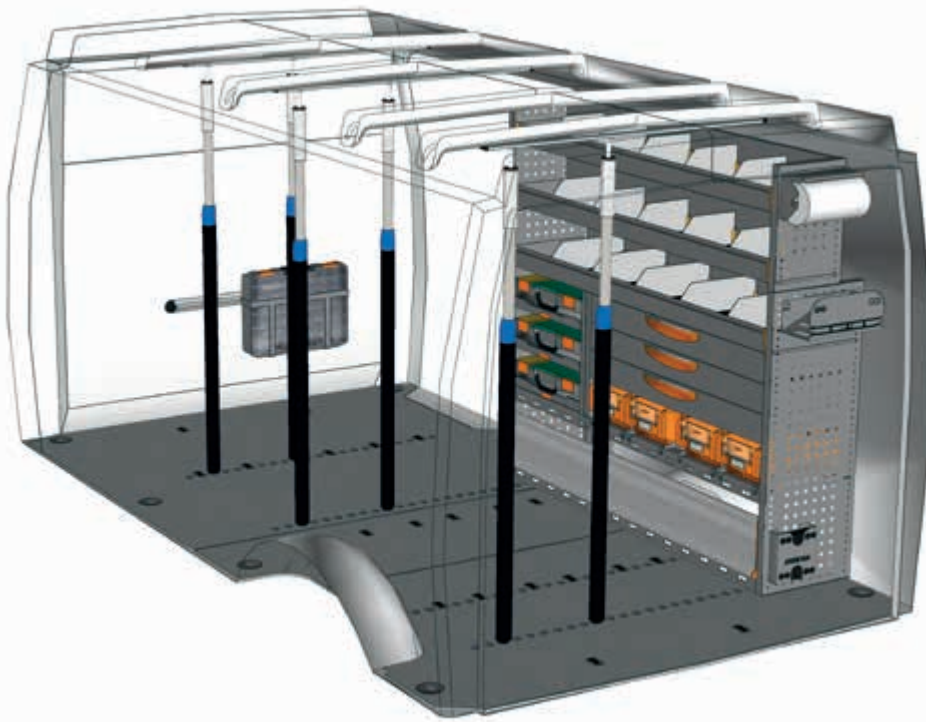

BEISPIEL - EXAMPLE

EXAMPLE DA L2H1 P2\*

- |                         |                         |
|-------------------------|-------------------------|
| 1 x DA 1514 P1          | 1 x F22 SB BOX080 00 01 |
| 1 x F22 SF DA20G1 J0 1S | 1 x F22 SB CPV080 00 01 |
| 6 x F22 FC V22131 00 00 | 2 x F22 FC V22136 00 00 |
| 1 x F22 FC V18029 10 00 | 2 x F22 FC V22124 00 00 |
| 2 x F22 FC V22106 00 00 | 2 x F22 FC V22148 00 00 |
| 3 x F22 FC V18025 10 00 | 1 x F22 SB YELLOW 63 05 |



siehe Seiten 12/13  
see pages 12/13

\* Einschließlich Befestigungskit - Fixing kit included

**Haben Sie Ihre Einrichtung nicht gefunden?**  
**Verlassen Sie sich auf die Profis für Fahrzeugeinrichtungen.**  
Auf der Rückseite dieses Katalogs finden Sie die nächstgelegene StoreVan Niederlassung. Besuchen Sie unsere Web-Seite.

**Didn't find the equipment you're looking for?**  
**Leave it to our experts.**  
See the back of this catalogue and contact the nearest StoreVan point or visit our website.





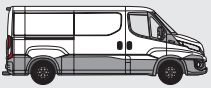

3520 H1

Frontantrieb - Front wheel drive

IVECO DAILY  
KASTENWAGEN - PANEL VAN

MOBILE

# L2 H1 MOBILE

FAHRZEUGEINRICHTUNGSBEISPIELE - FITTINGS EXAMPLES

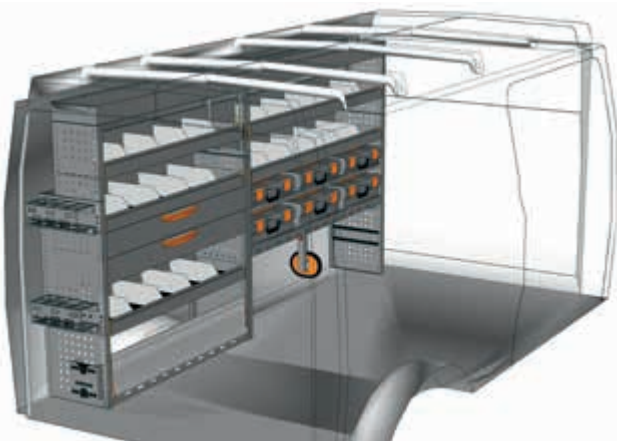

BEISPIEL - EXAMPLE

DA 2714 M1\*

B=2749 T=365 H=1440 mm - W=2749 D=365 H=1440 mm

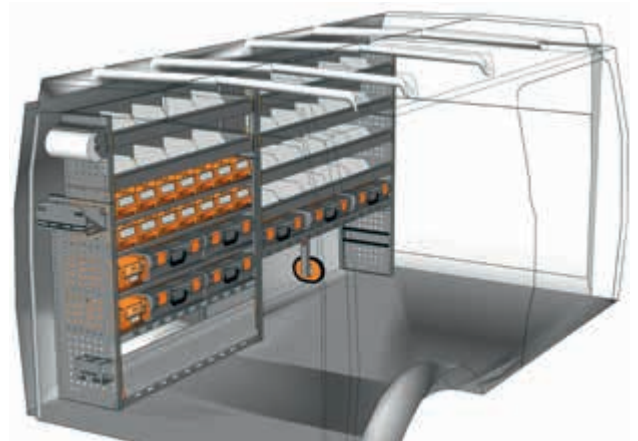
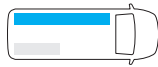

BEISPIEL - EXAMPLE

DA 2714 M2\*

B=2749 T=365 H=1440 mm - W=2749 D=365 H=1440 mm

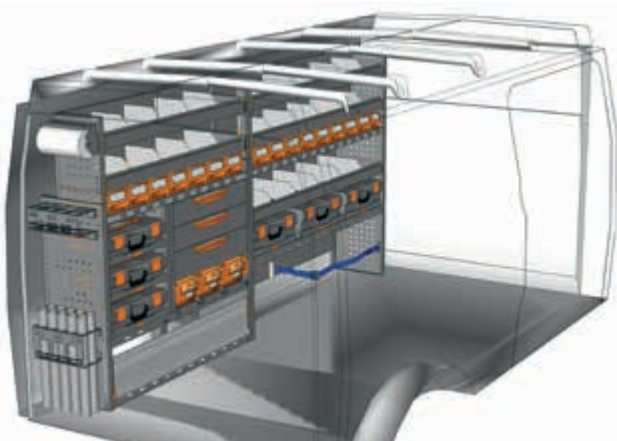

BEISPIEL - EXAMPLE

DA 2714 M3\*

B=2749 T=365 H=1440 mm - W=2749 D=365 H=1440 mm

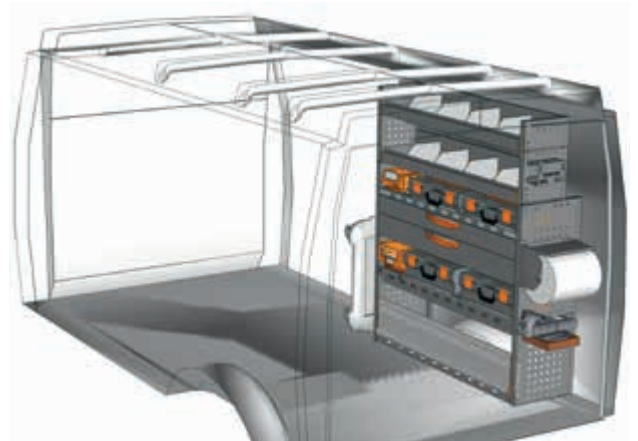
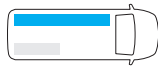

BEISPIEL - EXAMPLE

DA 1214 M4\*

B=1225 T=365 H=1400 mm - W=1225 D=365 H=1400 mm

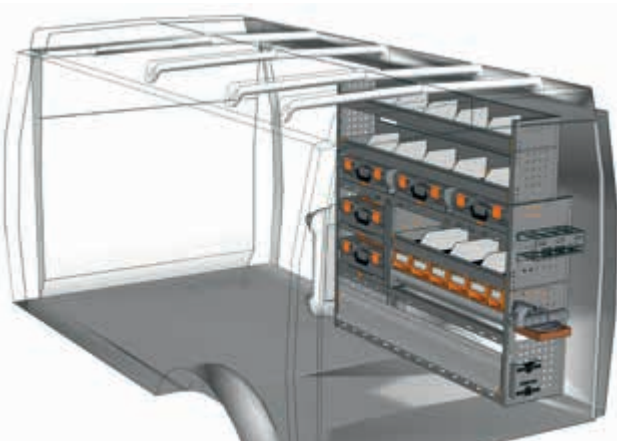

BEISPIEL - EXAMPLE

DA 1514 M1\*

B=1524 T=365 H=1400 mm - W=1524 D=365 H=1400 mm

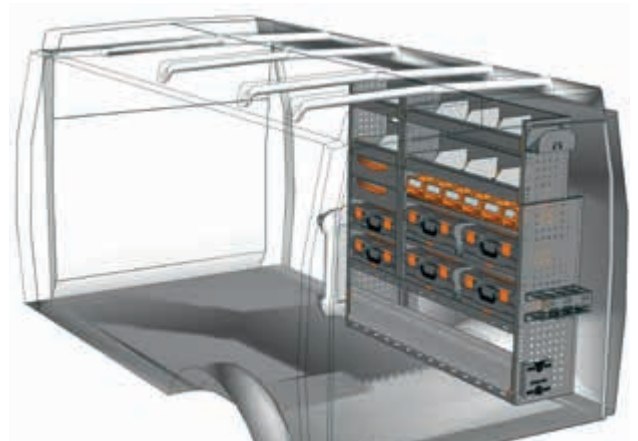
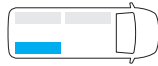

BEISPIEL - EXAMPLE

DA 1514 M2\*

B=1524 T=365 H=1400 mm - W=1524 D=365 H=1400 mm



\* Einschließlich Befestigungsset - Fixing kit included

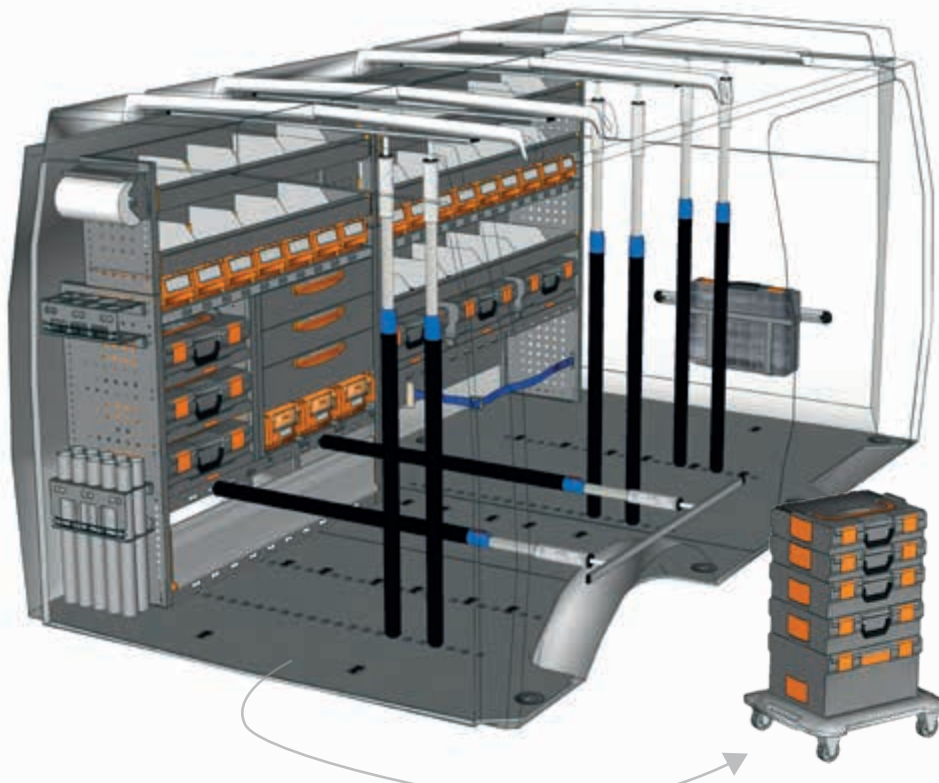
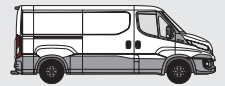

BEISPIEL - EXAMPLE

EXAMPLE DA L2H1 M1\*



- |                         |                         |
|-------------------------|-------------------------|
| 1 x DA 2714 M3          | 1 x F22 SB BOX080 00 01 |
| 1 x F22 SF DA20G1 J0 1S | 1 x F22 SB CPV080 00 01 |
| 8 x F22 FC V22131 00 00 | 2 x F22 FC V22136 00 00 |
| 1 x F22 FC V18029 10 00 | 2 x F22 FC V22124 00 00 |
| 2 x F22 FC V22106 00 00 | 2 x F22 FC V22148 00 00 |
| 5 x F22 FC V18025 15 00 | 1 x F22 SB YELLOW 63 05 |

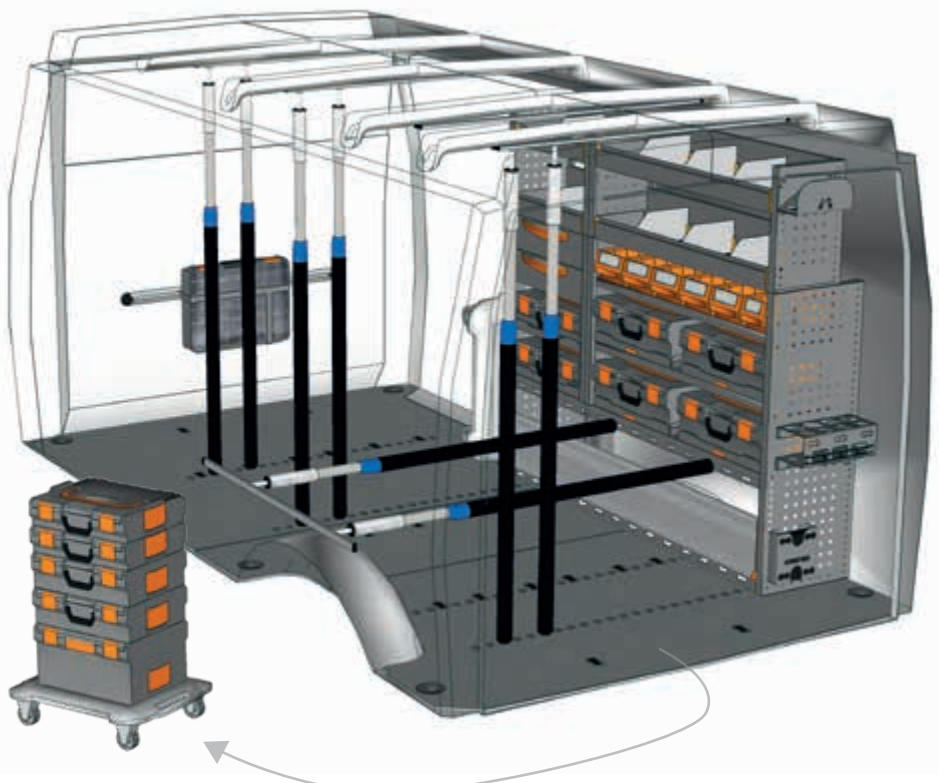

BEISPIEL - EXAMPLE

EXAMPLE DA L2H1 M2\*



- |                         |                         |
|-------------------------|-------------------------|
| 1 DA 1514 M2            | 1 x F22 SB BOX080 00 01 |
| 1 x F22 SF DA20G1 J0 1S | 1 x F22 SB CPV080 00 01 |
| 8 x F22 FC V22131 00 00 | 2 x F22 FC V22136 00 00 |
| 1 x F22 FC V18029 10 00 | 2 x F22 FC V22124 00 00 |
| 2 x F22 FC V22106 00 00 | 2 x F22 FC V22148 00 00 |
| 5 x F22 FC V18025 10 00 | 1 x F22 SB YELLOW 63 05 |



siehe Seiten 12/13  
see pages 12/13

\* Einschließlich Befestigungskit - Fixing kit included

**Haben Sie Ihre Einrichtung nicht gefunden?**  
**Verlassen Sie sich auf die Profis für Fahrzeugeinrichtungen.**  
Auf der Rückseite dieses Katalogs finden Sie die nächstgelegene StoreVan Niederlassung. Besuchen Sie unsere Web-Seite.

**Didn't find the equipment you're looking for?**  
**Leave it to our experts.**  
See the back of this catalogue and contact the nearest StoreVan point or visit our website.



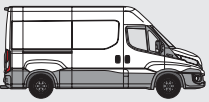

3520 H2

Frontantrieb - Front wheel drive

IVECO DAILY  
KASTENWAGEN - PANEL VAN

SAFETY

L2 H2

SAFETY

FAHRZEUGEINRICHTUNGSBEISPIELE - FITTINGS EXAMPLES

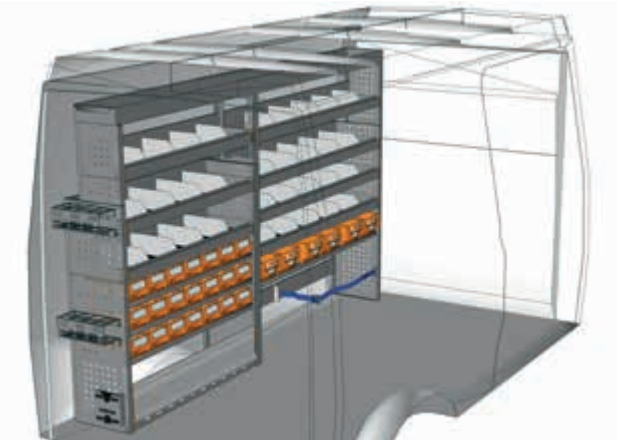

BEISPIEL - EXAMPLE

DA 2717 01\*

B=2749 T=365 H=1690 mm - W=2749 D=365 H=1690 mm

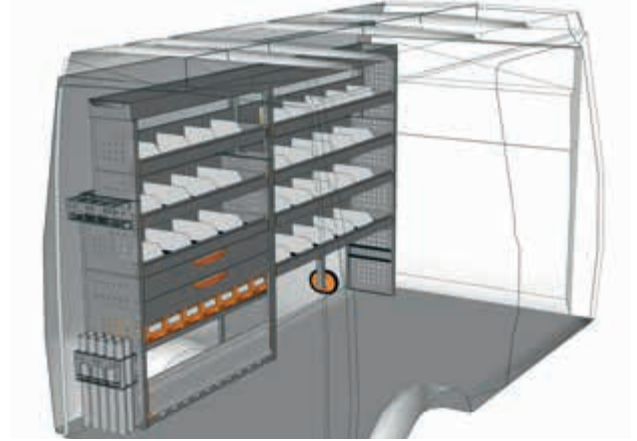
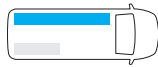

BEISPIEL - EXAMPLE

DA 2717 02\*

B=2749 T=365 H=1690 mm - W=2749 D=365 H=1690 mm

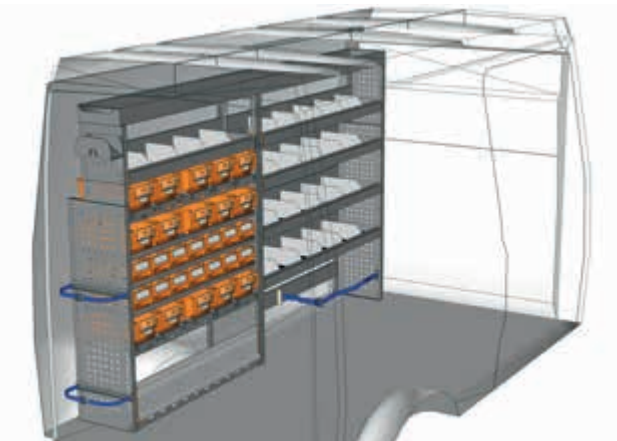

BEISPIEL - EXAMPLE

DA 2717 03\*

B=2749 T=365 H=1700 mm - W=2749 D=365 H=1700 mm

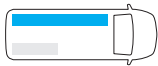

\* Einschließlich Befestigungs-Kit - Fixing kit included



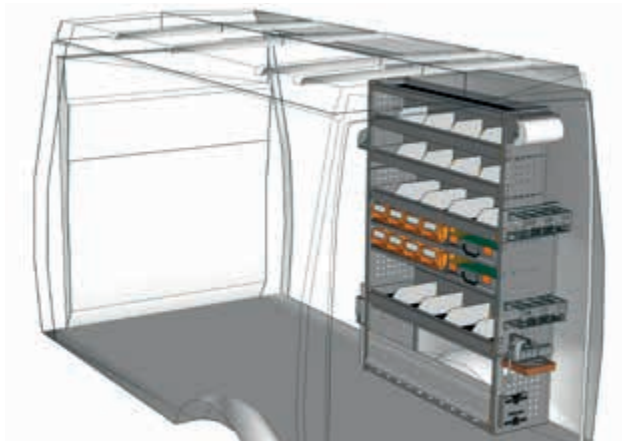

BEISPIEL - EXAMPLE

DA 1217 01\*

B=1225 T=365 H=1700 mm - W=1225 D=365 H=1700 mm

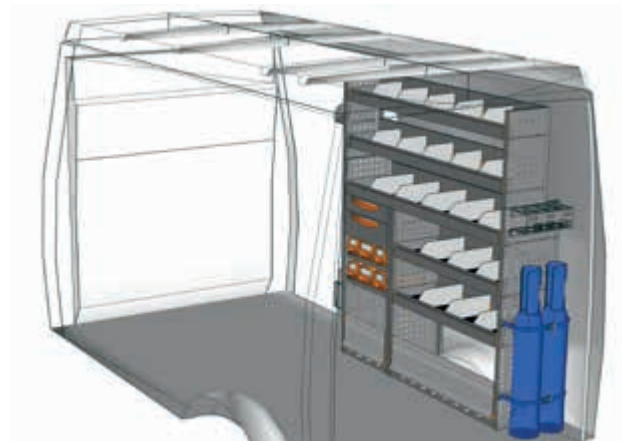
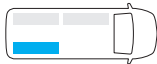

BEISPIEL - EXAMPLE

DA 1517 01\*

B=1524 T=365 H=1700 mm - W=1524 D=365 H=1700 mm

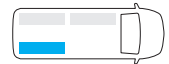

Ansicht von der Schiebetür  
View from side door

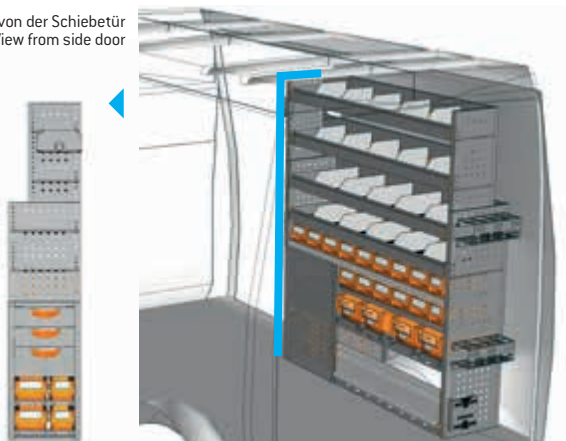

BEISPIEL - EXAMPLE

DA 1517 02\*

B=1524 T=365 H=1700 mm - W=1524 D=365 H=1700 mm

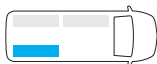

**Haben Sie Ihre Einrichtung nicht gefunden?**  
**Verlassen Sie sich auf die Profis für Fahrzeugeinrichtungen.**

Auf der Rückseite dieses Katalogs finden Sie die nächstgelegene StoreVan Niederlassung. Besuchen Sie unsere Web-Seite.

**Didn't find the equipment you're looking for?**  
**Leave it to our experts.**

See the back of this catalogue and contact the nearest StoreVan point or visit our website.



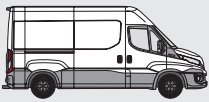

3520 H2

Frontantrieb - Front wheel drive

IVECO DAILY  
KASTENWAGEN - PANEL VAN

PROFESSIONAL

# L2 H2 PROFESSIONAL

FAHRZEUGEINRICHTUNGSBEISPIELE - FITTINGS EXAMPLES

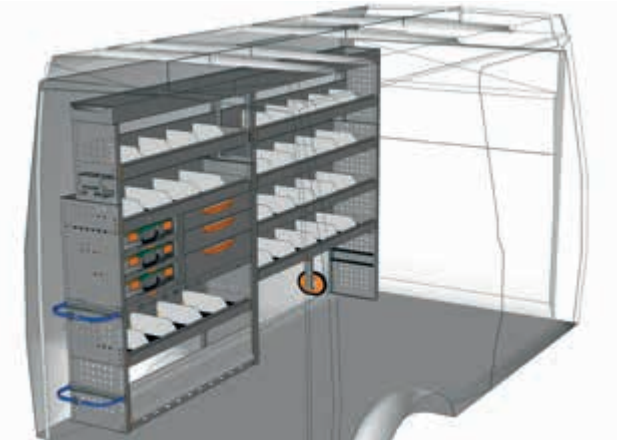

BEISPIEL - EXAMPLE

DA 2717 P1\*

B=2749 T=365 H=1690 mm - W=2749 D=365 H=1690 mm

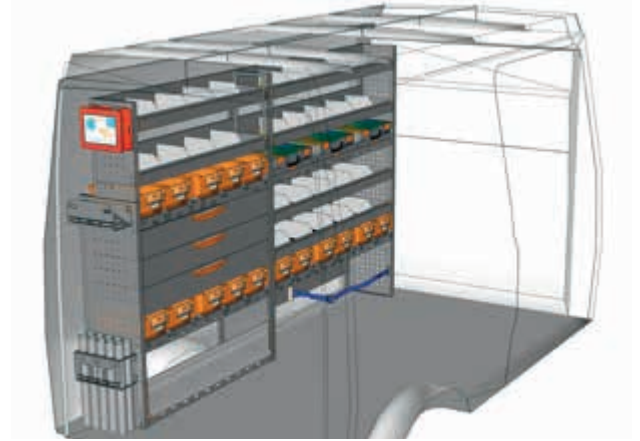
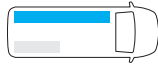

BEISPIEL - EXAMPLE

DA 2717 P2\*

B=2749 T=365 H=1690 mm - W=2749 D=365 H=1690 mm

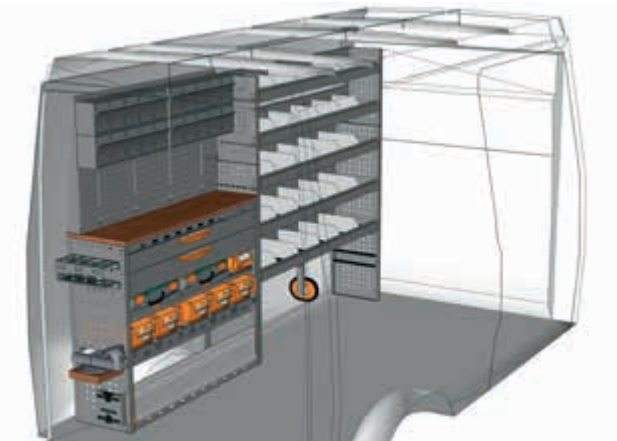
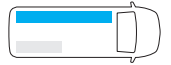

BEISPIEL - EXAMPLE

DA 2717 P3\*

B=2749 T=365 H=1700 mm - W=2749 D=365 H=1700 mm

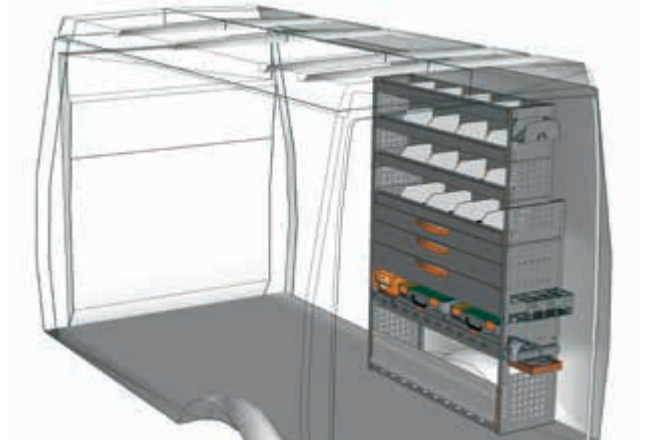
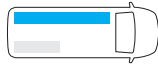

BEISPIEL - EXAMPLE

DA 1217 P1\*

B=1225 T=365 H=1700 mm - W=1225 D=365 H=1700 mm

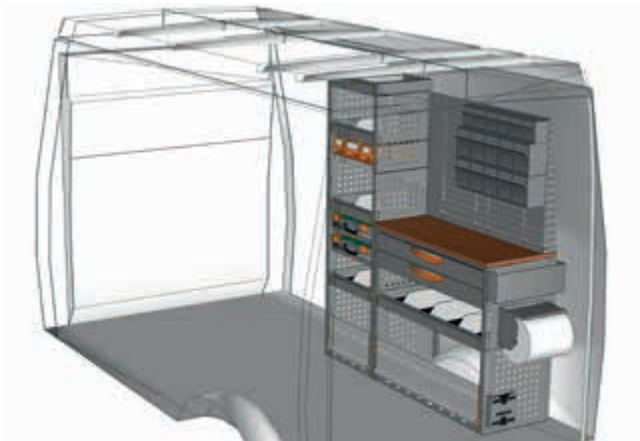
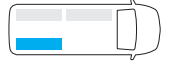

BEISPIEL - EXAMPLE

DA 1517 P2\*

B=1524 T=365 H=1700 mm - W=1524 D=365 H=1700 mm

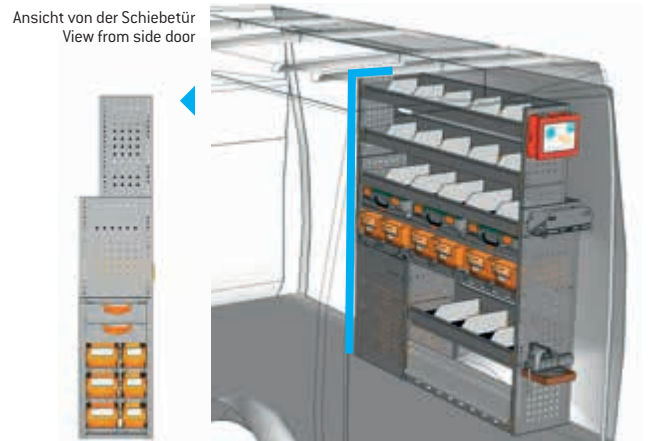
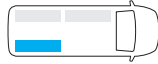

Ansicht von der Schiebetür  
View from side door

BEISPIEL - EXAMPLE

DA 1517 P3\*

B=1524 T=365 H=1700 mm - W=1524 D=365 H=1700 mm



\* Einschließlich Befestigungskit - Fixing kit included



BEISPIEL - EXAMPLE

EXAMPLE DA L2H2 P1\*



- |                         |                         |
|-------------------------|-------------------------|
| 1 x DA 2717 P2          | 1 x F22 SB BOX080 00 01 |
| 1 x F22 SF DA20G1 J0 1S | 1 x F22 SB CPV080 00 01 |
| 2 x F22 FC V22131 00 00 | 2 x F22 FC V22136 00 00 |
| 1 x F22 FC V18029 10 00 | 2 x F22 FC V22124 00 00 |
| 8 x F22 FC V22017 00 00 | 2 x F22 FC V22148 00 00 |
| 5 x F22 FC V18025 15 00 | 1 x F22 SB YELLOW 63 05 |

BEISPIEL - EXAMPLE

EXAMPLE DA L2H2 P2\*



- |                         |                         |
|-------------------------|-------------------------|
| 1 DA 1217 P1            | 1 x F22 SB BOX080 00 01 |
| 1 x F22 SF DA20G1 J0 1S | 1 x F22 SB CPV080 00 01 |
| 2 x F22 FC V22131 00 00 | 2 x F22 FC V22136 00 00 |
| 1 x F22 FC V18029 10 00 | 2 x F22 FC V22124 00 00 |
| 8 x F22 FC V22017 00 00 | 2 x F22 FC V22148 00 00 |
| 5 x F22 FC V18025 15 00 | 1 x F22 SB YELLOW 63 05 |

**Haben Sie Ihre Einrichtung nicht gefunden?  
Verlassen Sie sich auf die Profis für  
Fahrzeugeinrichtungen.**

Auf der Rückseite dieses Katalogs  
finden Sie die nächstgelegene  
StoreVan Niederlassung.  
Besuchen Sie unsere Web-Seite.

**Didn't find the equipment  
you're looking for?**

**Leave it to our experts.**  
See the back of this catalogue  
and contact the nearest  
StoreVan point or visit our website.



siehe Seiten 12/13  
see pages 12/13

\* Einschließlich Befestigungskit - Fixing kit included





3520 H2

Frontantrieb - Front wheel drive

IVECO DAILY  
KASTENWAGEN - PANEL VAN

MOBILE

# L2 H2 MOBILE

FAHRZEUGEINRICHTUNGSBEISPIELE - FITTINGS EXAMPLES

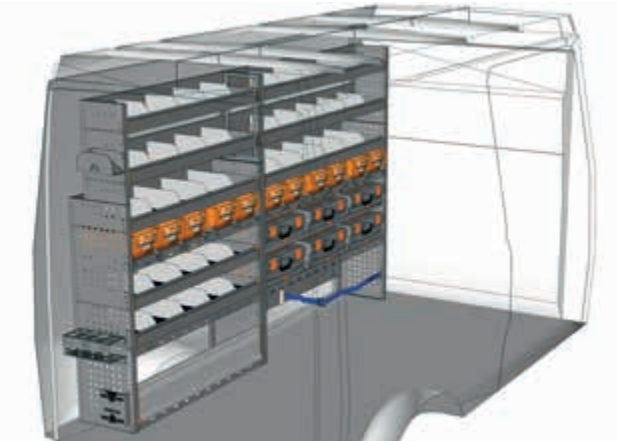

BEISPIEL - EXAMPLE

DA 2717 M1\*

B=2749 T=365 H=1690 mm - W=2749 D=365 H=1690 mm

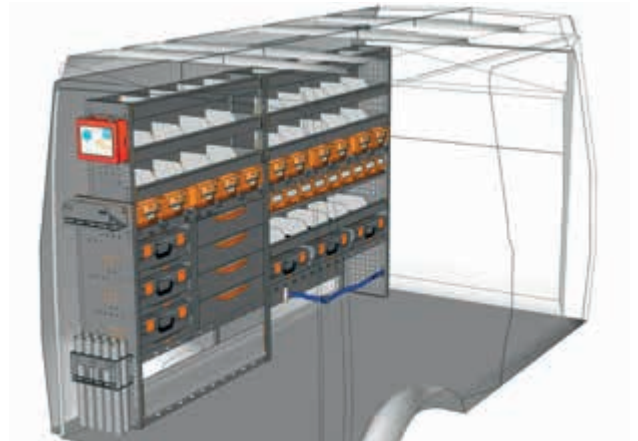
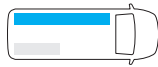

BEISPIEL - EXAMPLE

DA 2717 M2\*

B=2749 T=365 H=1690 mm - W=2749 D=365 H=1690 mm

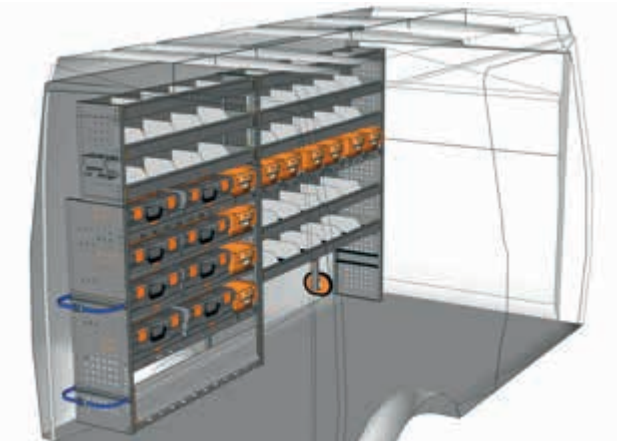

BEISPIEL - EXAMPLE

DA 2717 M3\*

B=2749 T=365 H=1700 mm - W=2749 D=365 H=1700 mm

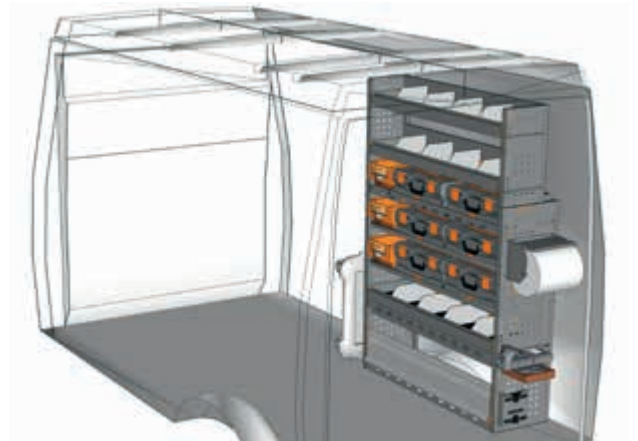
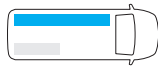

BEISPIEL - EXAMPLE

DA 1217 M1\*

B=1225 T=365 H=1700 mm - W=1225 D=365 H=1700 mm

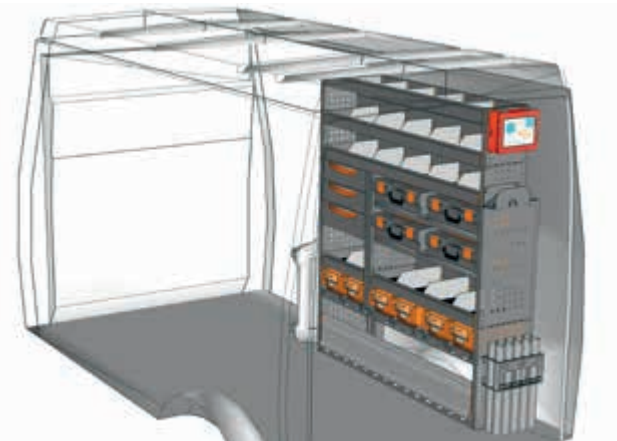

BEISPIEL - EXAMPLE

DA 1517 M2\*

B=1524 T=365 H=1700 mm - W=1524 D=365 H=1700 mm

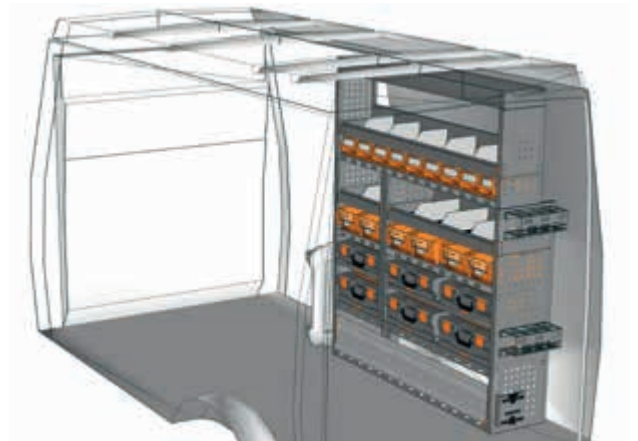
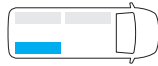

BEISPIEL - EXAMPLE

DA 1517 M3\*

B=1524 T=365 H=1700 mm - W=1524 D=365 H=1700 mm



\* Einschließlich Befestigungskit - Fixing kit included



BEISPIEL - EXAMPLE

EXAMPLE DA L2H2 M1\*



- |                         |                         |
|-------------------------|-------------------------|
| 1 DA 2717 M3            | 1 x F22 SB BOX080 00 01 |
| 1 x F22 SF DA20G1 J0 1S | 1 x F22 SB CPV080 00 01 |
| 2 x F22 FC V22131 00 00 | 2 x F22 FC V22136 00 00 |
| 1 x F22 FC V18029 10 00 | 2 x F22 FC V22124 00 00 |
| 8 x F22 FC V22017 00 00 | 2 x F22 FC V22148 00 00 |
| 5 x F22 FC V18025 15 00 | 1 x F22 SB YELLOW 63 05 |

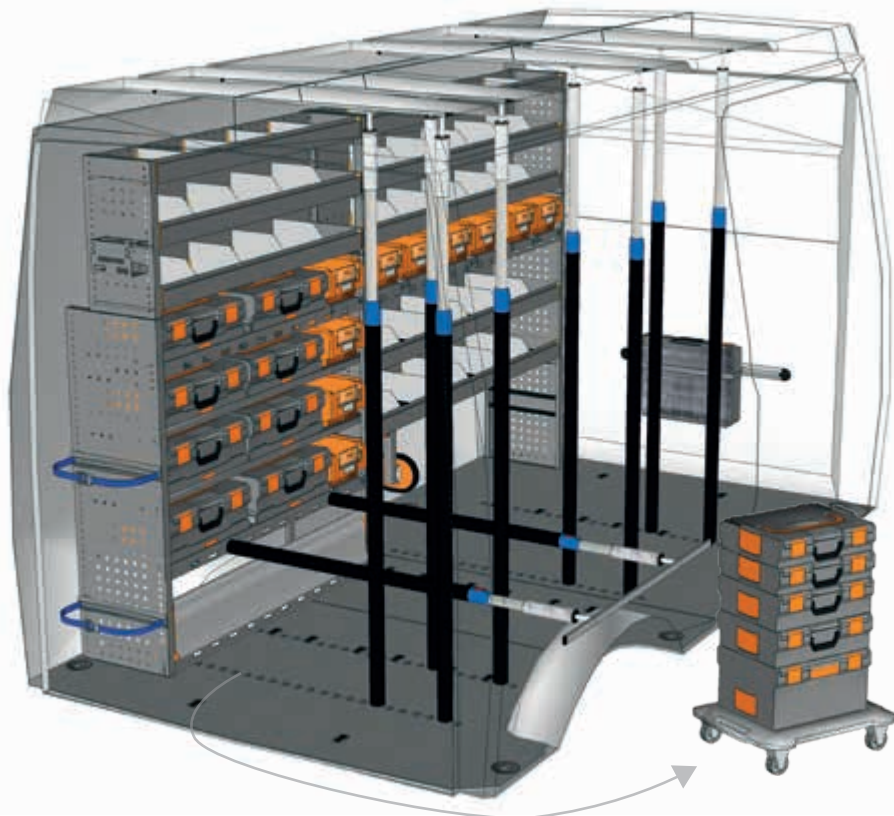

BEISPIEL - EXAMPLE

EXAMPLE DA L2H2 M2\*



- |                         |                         |
|-------------------------|-------------------------|
| 1 DA 1517 M3            | 1 x F22 SB BOX080 00 01 |
| 1 x F22 SF DA20G1 J0 1S | 1 x F22 SB CPV080 00 01 |
| 2 x F22 FC V22131 00 00 | 2 x F22 FC V22136 00 00 |
| 1 x F22 FC V18029 10 00 | 2 x F22 FC V22124 00 00 |
| 8 x F22 FC V22017 00 00 | 2 x F22 FC V22148 00 00 |
| 5 x F22 FC V18025 10 00 | 1 x F22 SB YELLOW 63 05 |

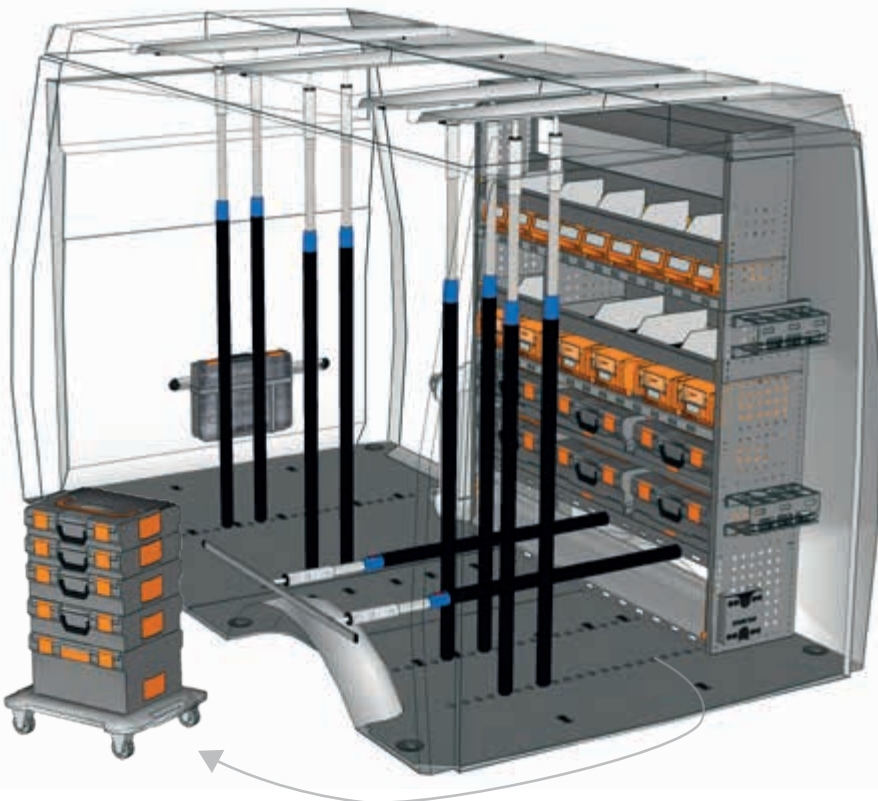

**Haben Sie Ihre Einrichtung nicht gefunden?**  
**Verlassen Sie sich auf die Profis für Fahrzeugeinrichtungen.**  
 Auf der Rückseite dieses Katalogs finden Sie die nächstgelegene StoreVan Niederlassung. Besuchen Sie unsere Web-Seite.

**Didn't find the equipment you're looking for?**  
**Leave it to our experts.**  
 See the back of this catalogue and contact the nearest StoreVan point or visit our website.

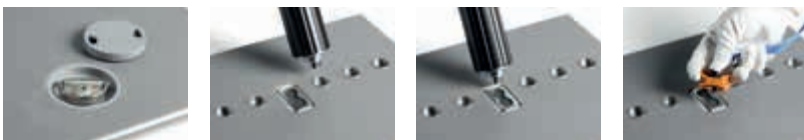

siehe Seiten 12/13  
see pages 12/13

\* Einschließlich Befestigungskit - Fixing kit included

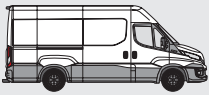

# L2L H2 SAFETY

FAHRZEUGEINRICHTUNGSBEISPIELE - FITTINGS EXAMPLES

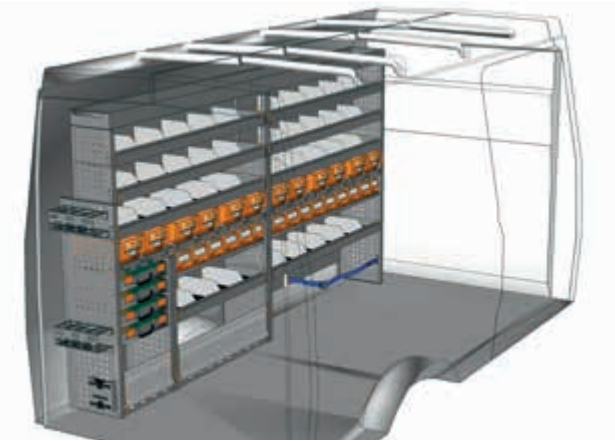

BEISPIEL - EXAMPLE

DA 3017 01\*

B=3048 T=365 H=1690 mm - W=3048 D=365 H=1690 mm

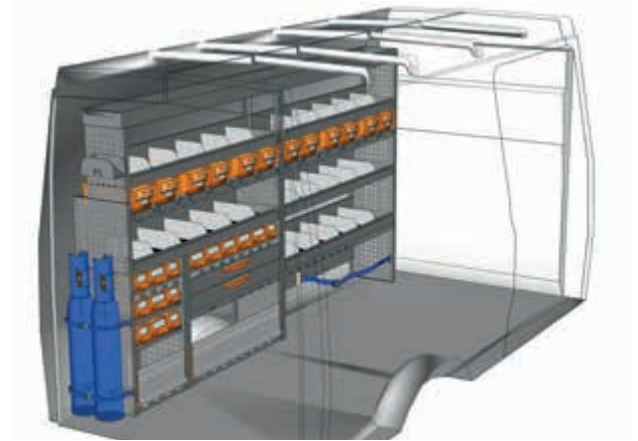
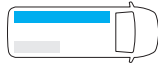

BEISPIEL - EXAMPLE

DA 3017 02\*

B=3048 T=365 H=1690 mm - W=3048 D=365 H=1690 mm

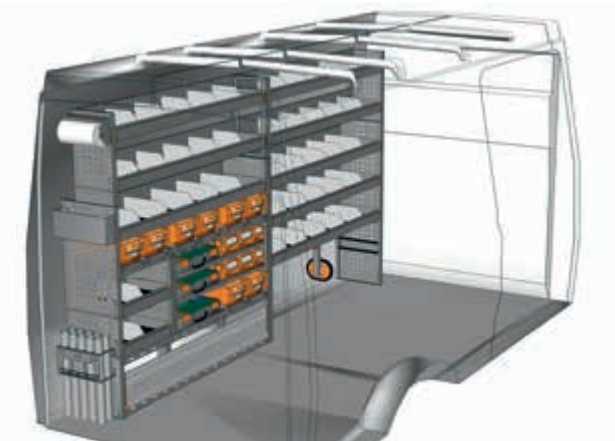
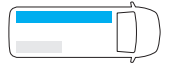

BEISPIEL - EXAMPLE

DA 3017 03\*

B=3048 T=365 H=1690 mm - W=3048 D=365 H=1690 mm

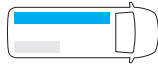

\* Einschließlich Befestigungsset - Fixing kit included



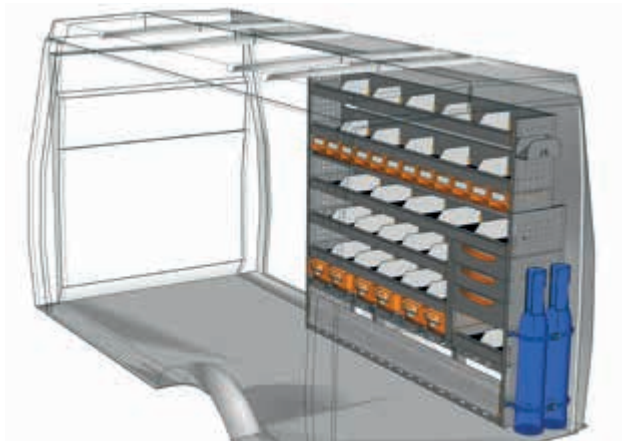

BEISPIEL - EXAMPLE

DA 2017 01\*

B=2032 T=365 H=1700 mm - W=2032 D=365 H=1700 mm

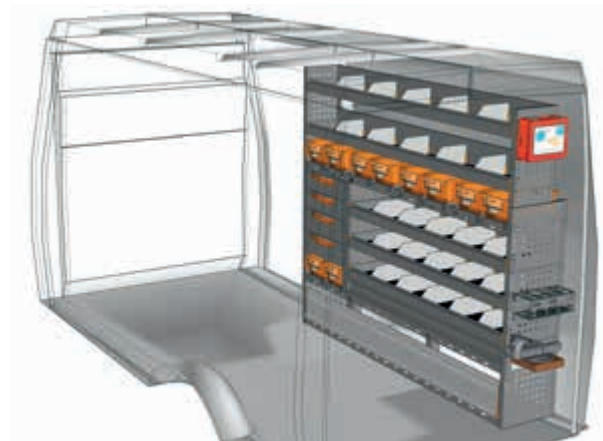
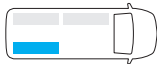

BEISPIEL - EXAMPLE

DA 2017 02\*

B=2032 T=365 H=1700 mm - W=2032 D=365 H=1700 mm



Ansicht von der Schiebetür  
View from side door

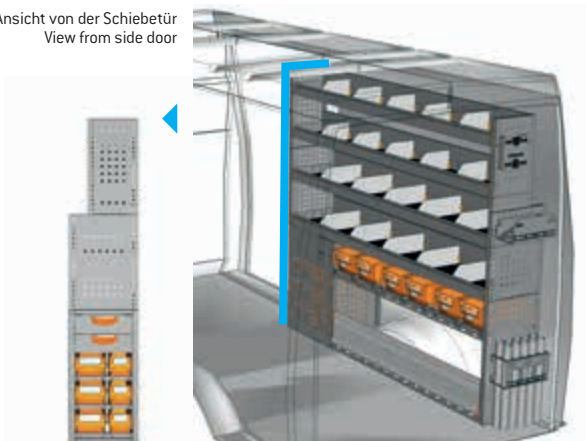

BEISPIEL - EXAMPLE

DA 2017 03\*

B=2032 T=365 H=1700 mm - W=2032 D=365 H=1700 mm

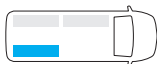

**Haben Sie Ihre Einrichtung nicht gefunden?**  
**Verlassen Sie sich auf die Profis für Fahrzeugeinrichtungen.**

Auf der Rückseite dieses Katalogs finden Sie die nächstgelegene StoreVan Niederlassung. Besuchen Sie unsere Web-Seite.

**Didn't find the equipment you're looking for?**  
**Leave it to our experts.**

See the back of this catalogue and contact the nearest StoreVan point or visit our website.





# L2L H2 PROFESSIONAL

FAHRZEUGEINRICHTUNGSBEISPIELE - FITTINGS EXAMPLES

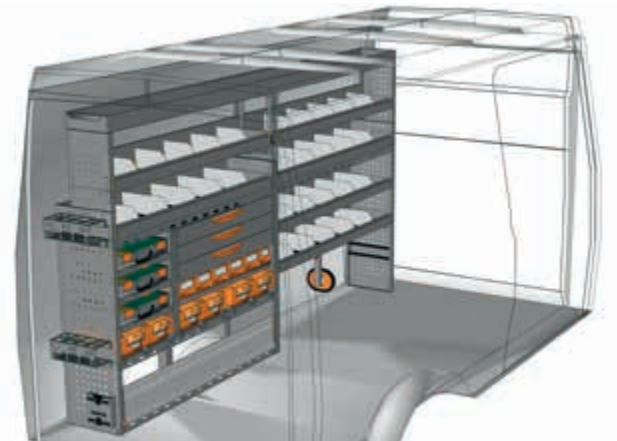

BEISPIEL - EXAMPLE

DA 3017 P1\*

B=3048 T=365 H=1690 mm - W=3048 D=365 H=1690 mm

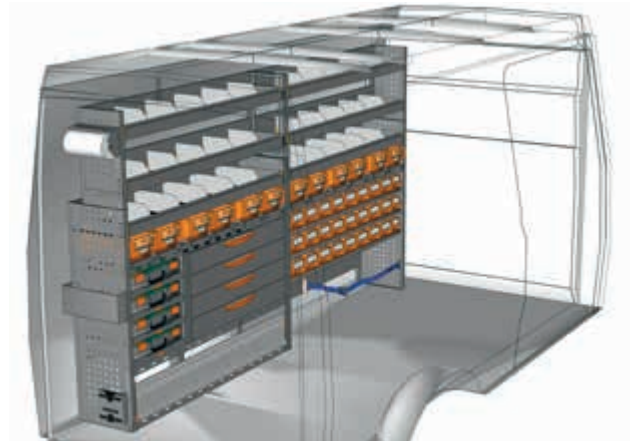

BEISPIEL - EXAMPLE

DA 3017 P2\*

B=3048 T=365 H=1690 mm - W=3048 D=365 H=1690 mm

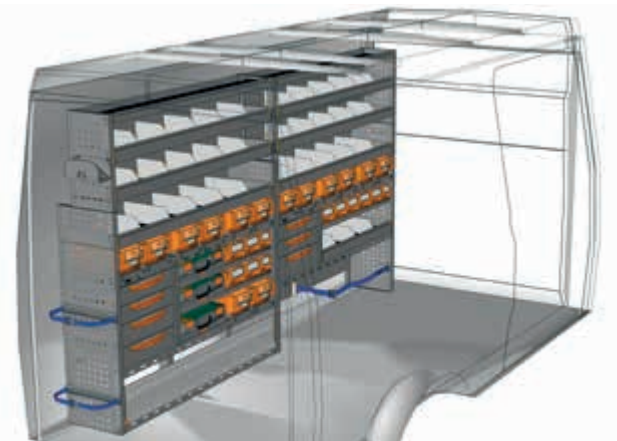

BEISPIEL - EXAMPLE

DA 3017 P3\*

B=3048 T=365 H=1690 mm - W=3048 D=365 H=1690 mm

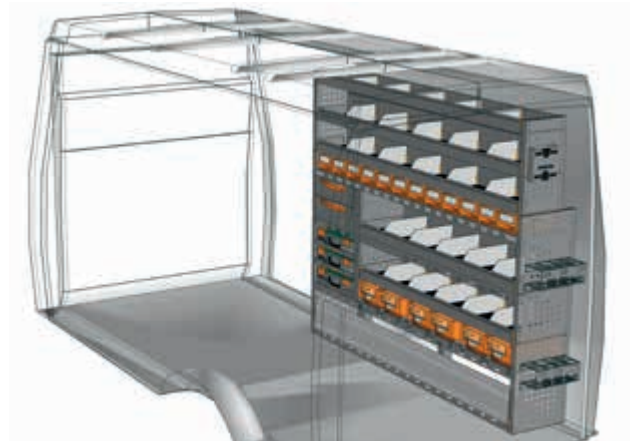

BEISPIEL - EXAMPLE

DA 2017 P1\*

B=2032 T=365 H=1700 mm - W=2032 D=365 H=1700 mm

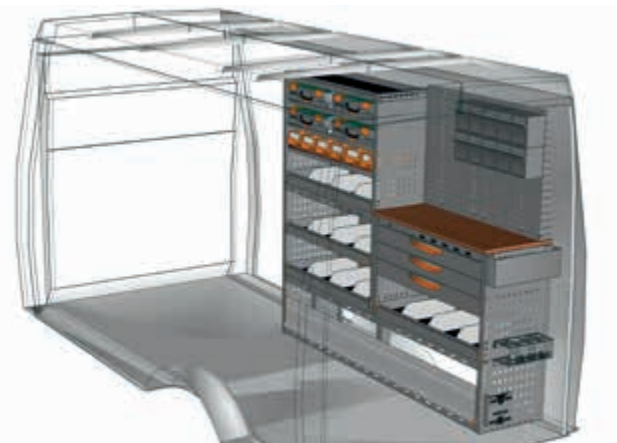

BEISPIEL - EXAMPLE

DA 2017 P2\*

B=2032 T=365 H=1700 mm - W=2032 D=365 H=1700 mm



Ansicht von der Schiebetür  
View from side door

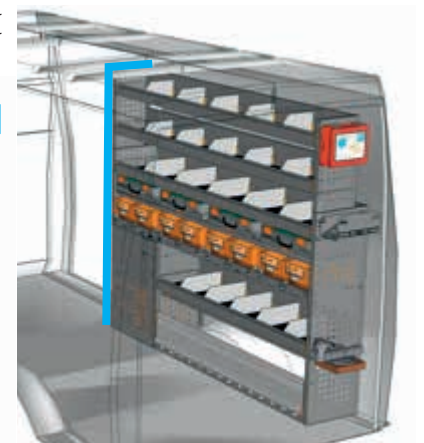

BEISPIEL - EXAMPLE

DA 2017 P3\*

B=2032 T=365 H=1700 mm - W=2032 D=365 H=1700 mm



\* Einschließlich Befestigungskit - Fixing kit included

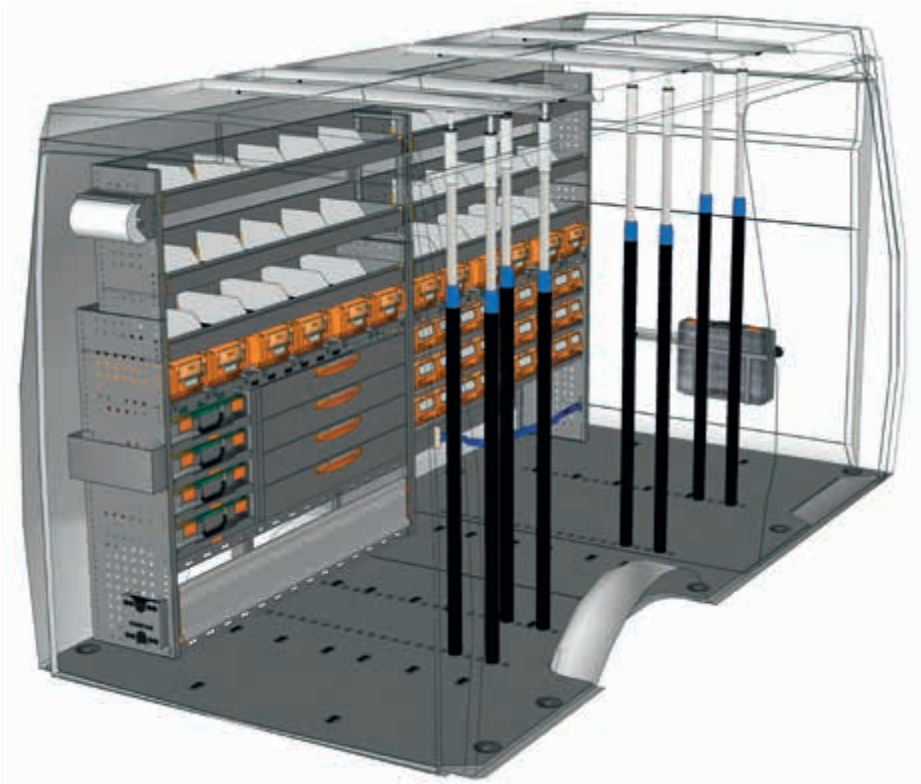

BEISPIEL - EXAMPLE

EXAMPLE DA L2LH2 P1\*



- |                         |                         |
|-------------------------|-------------------------|
| 1 x DA 3017 P2          | 1 x F22 SB BOX080 00 01 |
| 1 x F22 SF DA2LG1 J0 1S | 1 x F22 SB CPV080 00 01 |
| 2 x F22 FC V22106 00 00 | 2 x F22 FC V22136 00 00 |
| 1 x F22 FC V18029 10 00 | 2 x F22 FC V22124 00 00 |
| 8 x F22 FC V22017 00 00 | 2 x F22 FC V22148 00 00 |
| 4 x F22 FC V18025 15 00 | 1 x F22 SB YELLOW 63 05 |

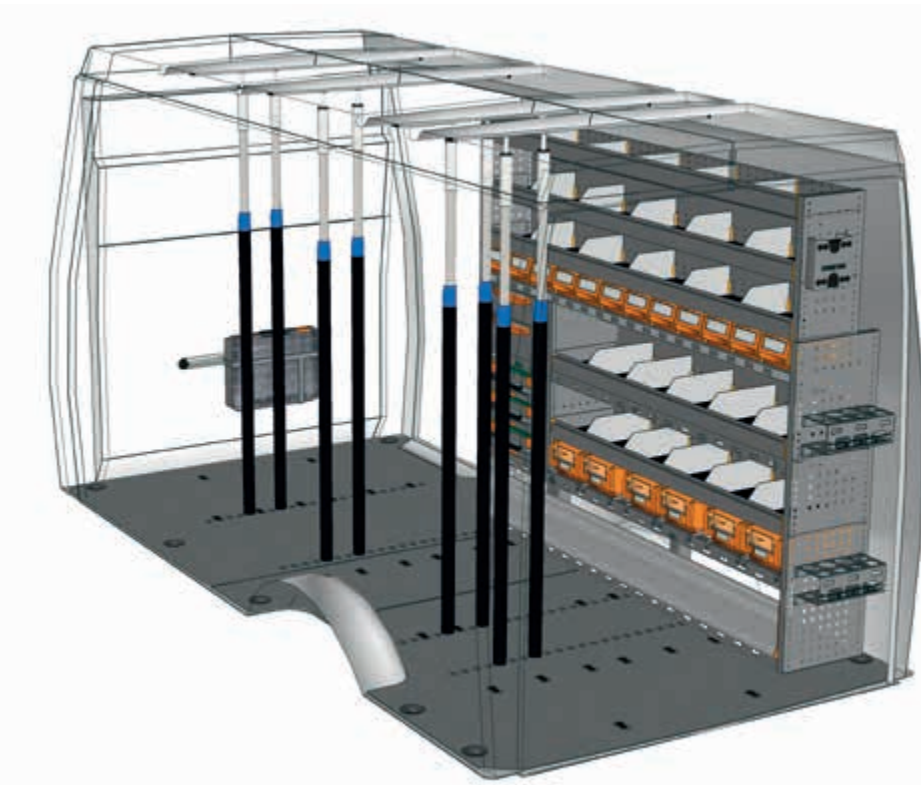

BEISPIEL - EXAMPLE

EXAMPLE DA L2LH2 P2\*



- |                         |                         |
|-------------------------|-------------------------|
| 1 DA 2017 P1            | 1 x F22 SB BOX080 00 01 |
| 1 x F22 SF DA2LG1 J0 1S | 1 x F22 SB CPV080 00 01 |
| 2 x F22 FC V22106 00 00 | 2 x F22 FC V22136 00 00 |
| 1 x F22 FC V18029 10 00 | 2 x F22 FC V22124 00 00 |
| 8 x F22 FC V22017 00 00 | 2 x F22 FC V22148 00 00 |
| 4 x F22 FC V18025 15 00 | 1 x F22 SB YELLOW 63 05 |

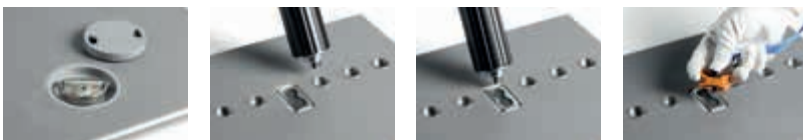

siehe Seiten 12/13  
see pages 12/13

\* Einschließlich Befestigungskit - Fixing kit included

**Haben Sie Ihre Einrichtung nicht gefunden?**  
**Verlassen Sie sich auf die Profis für Fahrzeugeinrichtungen.**  
Auf der Rückseite dieses Katalogs finden Sie die nächstgelegene StoreVan Niederlassung. Besuchen Sie unsere Web-Seite.

**Didn't find the equipment you're looking for?**  
**Leave it to our experts.**  
See the back of this catalogue and contact the nearest StoreVan point or visit our website.





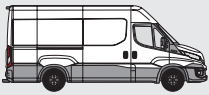

# L2L H2 MOBILE

## FAHRZEUGEINRICHTUNGSBEISPIELE - FITTINGS EXAMPLES

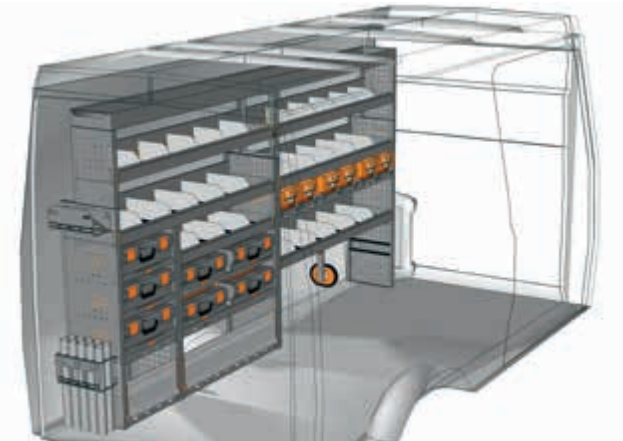

BEISPIEL - EXAMPLE

DA 3017 M1\*

B=3048 T=365 H=1690 mm - W=3048 D=365 H=1690 mm

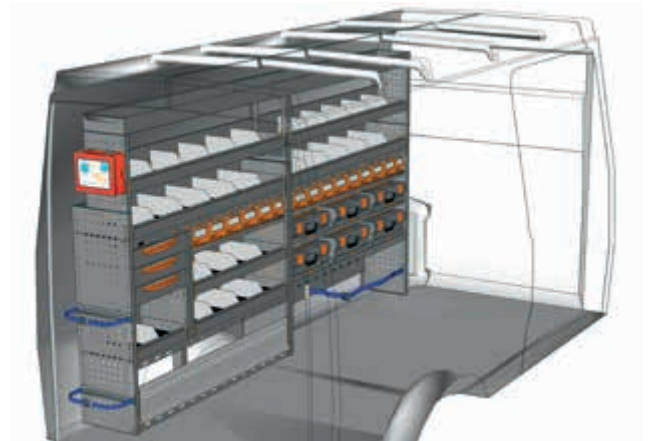

BEISPIEL - EXAMPLE

DA 3017 M2\*

B=3048 T=365 H=1690 mm - W=3048 D=365 H=1690 mm

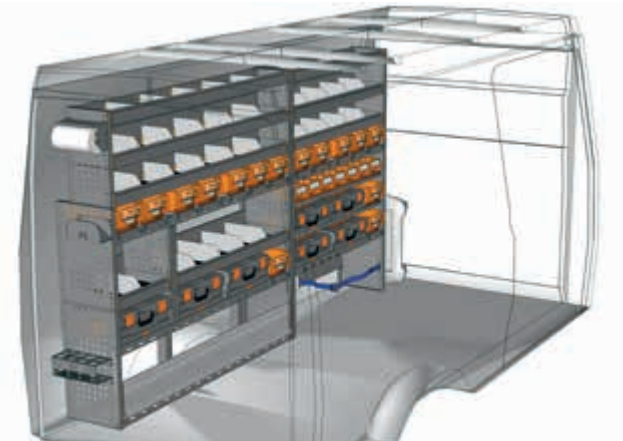
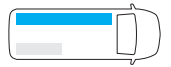

BEISPIEL - EXAMPLE

DA 3017 M3\*

B=3048 T=365 H=1690 mm - W=3048 D=365 H=1690 mm

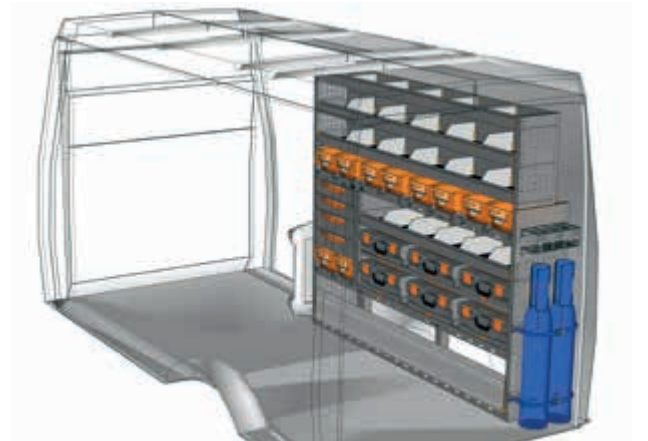

BEISPIEL - EXAMPLE

DA 2017 M1\*

B=2032 T=365 H=1700 mm - W=2032 D=365 H=1700 mm

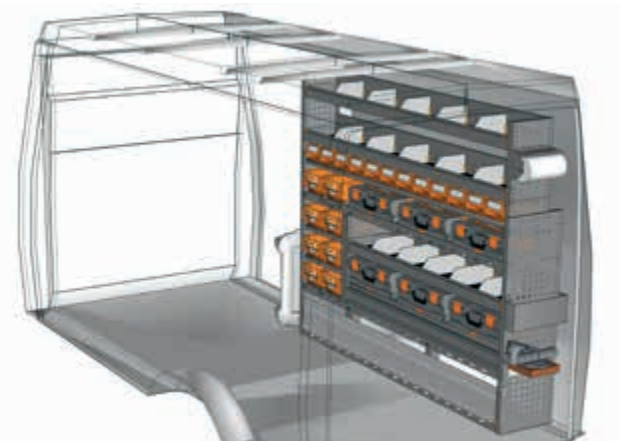

BEISPIEL - EXAMPLE

DA 2017 M2\*

B=2032 T=365 H=1700 mm - W=2032 D=365 H=1700 mm

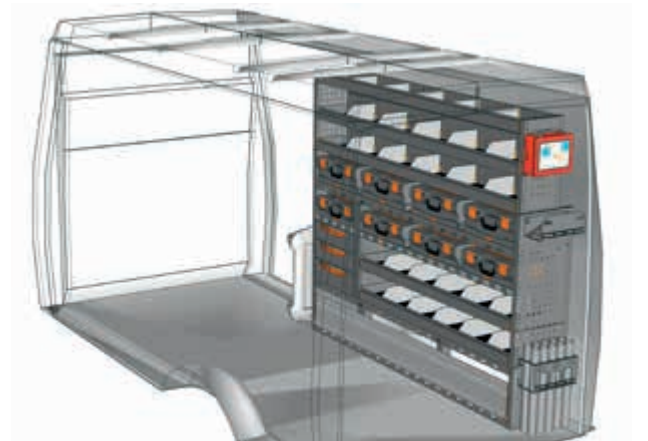
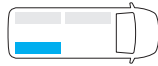

BEISPIEL - EXAMPLE

DA 2017 M3\*

B=2032 T=365 H=1700 mm - W=2032 D=365 H=1700 mm



\* Einschließlich Befestigungskit - Fixing kit included

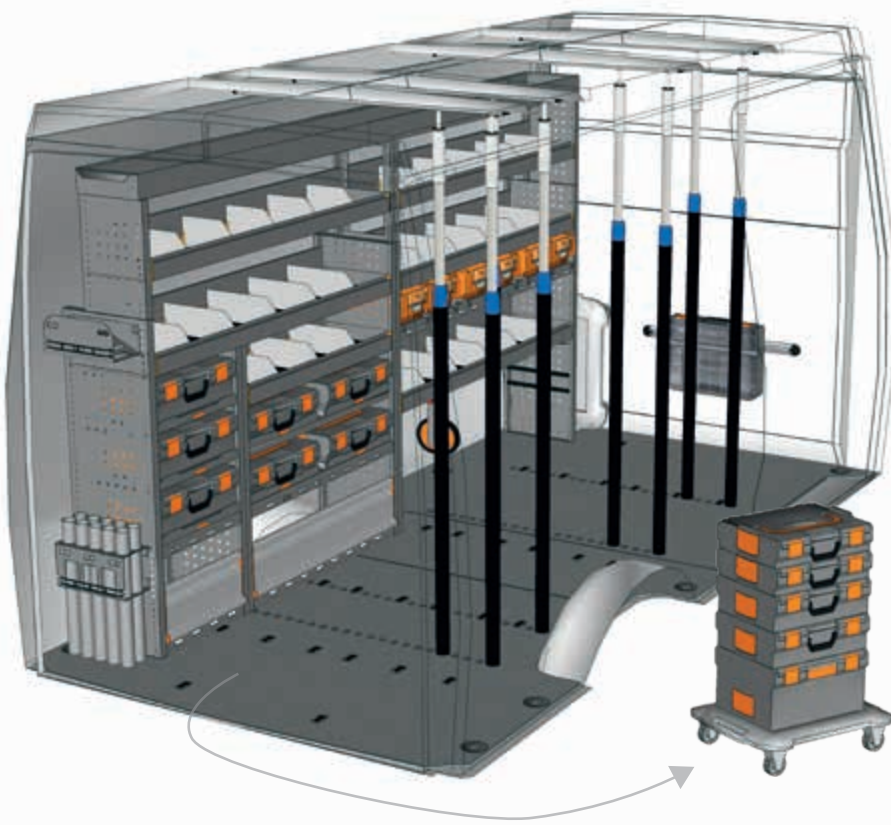

BEISPIEL - EXAMPLE

EXAMPLE DA L2LH2 M1\*



- |                         |                         |
|-------------------------|-------------------------|
| 1 x DA 3017 M1          | 1 x F22 SB BOX080 00 01 |
| 1 x F22 SF DA2LG1 J0 1S | 1 x F22 SB CPV080 00 01 |
| 2 x F22 FC V22106 00 00 | 2 x F22 FC V22136 00 00 |
| 1 x F22 FC V18029 10 00 | 2 x F22 FC V22124 00 00 |
| 8 x F22 FC V22017 00 00 | 2 x F22 FC V22148 00 00 |
| 4 x F22 FC V18025 15 00 | 1 x F22 SB YELLOW 63 05 |

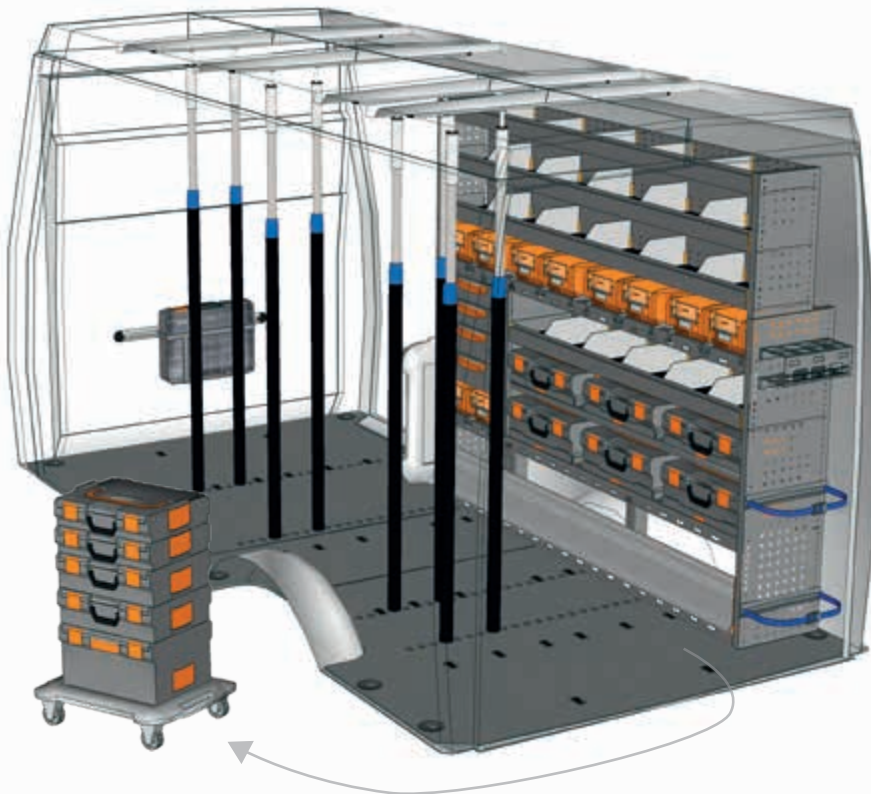

BEISPIEL - EXAMPLE

EXAMPLE DA L2LH2 M2\*



- |                         |                         |
|-------------------------|-------------------------|
| 1 DA 2017 M1            | 1 x F22 SB BOX080 00 01 |
| 1 x F22 SF DA2LG1 J0 1S | 1 x F22 SB CPV080 00 01 |
| 2 x F22 FC V22106 00 00 | 2 x F22 FC V22136 00 00 |
| 1 x F22 FC V18029 10 00 | 2 x F22 FC V22124 00 00 |
| 8 x F22 FC V22017 00 00 | 2 x F22 FC V22148 00 00 |
| 4 x F22 FC V18025 15 00 | 1 x F22 SB YELLOW 63 05 |



siehe Seiten 12/13  
see pages 12/13

\* Einschließlich Befestigungskit - Fixing kit included

**Haben Sie Ihre Einrichtung nicht gefunden?**  
**Verlassen Sie sich auf die Profis für Fahrzeugeinrichtungen.**  
Auf der Rückseite dieses Katalogs finden Sie die nächstgelegene StoreVan Niederlassung. Besuchen Sie unsere Web-Seite.

**Didn't find the equipment you're looking for?**  
**Leave it to our experts.**  
See the back of this catalogue and contact the nearest StoreVan point or visit our website.





FAHRZEUG VEHICLE	DACHTRAVERSEN ROOF RACK BARS	ABMESSUNGEN DIMENSIONS	GEWICHT WEIGHT	TRAGKRAFT LOAD CAPACITY
	ART.			
Fahrzeugtyp - Model L1 H1 · 3000 H1	<b>F22 KK DA10H1 B1 00</b>	1800x1660 mm	11,50 kg	188,50 kg
Fahrzeugtyp - Model L2 H1 · 3520 H1	<b>F22 KK DA20H1 B1 00</b>	1300x1660 mm	8,00 kg	192,00 kg
Fahrzeugtyp - Model L2 H2 · 3520 H2	<b>F22 KK DA20H2 B1 00</b>	2100x1560 mm	11,00 kg	189,00 kg
Fahrzeugtyp - Model L2L H2 · 3520L H2	<b>F22 KK DA2LH2 B1 00</b>	2100x1560 mm	11,00 kg	189,00 kg

- Nur für Fahrzeug mit Heckflügeltüren.
- Only for vehicle with rear leaf doors.

**DACHTRAVERSEN - ROOF RACK BARS**

- Dachtraversen bestehend aus:
  - Alu-Querschienen inkl. Befestigungen und Gummiprofilen
  - Schraubmaterial aus Edelstahl
- Roof Rack Bars complete of:
  - aluminium crossbars with fixing parts and rubber profile
  - fixing screws in stainless steel



FAHRZEUG VEHICLE	DACHTRÄGER ROOF RACK	ABMESSUNGEN DIMENSIONS	GEWICHT WEIGHT	TRAGKRAFT LOAD CAPACITY
	ART.			
Fahrzeugtyp - Model L1 H1 · 3000 H1	<b>F22 KK DA10H1 R1 00</b>	2750x1700 mm	21,00 kg	179,00 kg
Fahrzeugtyp - Model L2 H1 · 3520 H1	<b>F22 KK DA20H1 R1 00</b>	3400x1700 mm	22,00 kg	178,00 kg
Fahrzeugtyp - Model L2 H2 · 3520 H2	<b>F22 KK DA20H2 R1 00</b>	3400x1600 mm	25,00 kg	175,00 kg
Fahrzeugtyp - Model L2L H2 · 3520L H2	<b>F22 KK DA2LH2 R1 00</b>	3400x1600 mm	25,00 kg	175,00 kg

- Nur für Fahrzeug mit Heckflügeltüren.
- Only for vehicle with rear leaf doors.

**DACHTRÄGER - ROOF RACK**

- Dachträger bestehend aus:
  - Alu-Querschienen inkl. Befestigungen und Gummiprofilen
  - Seitenwänden aus Aluminium
  - Laderolle aus Aluminium
  - Schraubmaterial aus Edelstahl
- Roof Rack complete of:
  - aluminium crossbars with fixing parts and rubber profile
  - aluminium side rails
  - aluminium loading roller
  - fixing screws in stainless steel



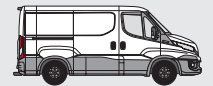

- Kappen paarweise
- Pair of end caps

ART. **F22 UP 070010 00 07**



- Endlaschen light paarweise
- Pair of light end fins

ART. **F22 UP 070040 00 07**  
73x100 mm H



- Endlaschen strong paarweise
- Pair of strong end fins

ART. **F22 UP 070050 00 07**  
60x53x200 mm H



- Mittellasche rechts light
- Central right-hand fin

ART. **F22 UP 070060 00 07**  
133x53x64 mm H



- Mittellasche links light
- Central left-hand fin

ART. **F22 UP 070070 00 07**  
133x53x64 mm H



- Anschläge paarweise
- Pair of stops

ART. **F22 UP 070100 00 07**  
70x33x90 mm H



- Klappbarer Anschlag light
- Light collapsible stop

ART. **F22 UP 070080 00 ZZ**



- Klappbarer Anschlag strong
- Strong collapsible stop

ART. **F22 UP 070090 00 ZZ**



- Set Halterung für Blinklicht\*
- Warning light support kit\*

ART. **F22 UP 070170 00 07**  
200x161 mm



- Set Befestigung für Rolle
- Roll fixing kit

ART. **F22 UP 070180 00 ZZ**



- Selbstsperrender Riemen
- Self-locking strap

ART. **F22 CMV 23575 00 00**  
1000x25 mm H  
**F22 CMV 97020 00 00**  
1200x35 mm H



- Rohrträger aus Edelstahl
- Stainless steel tube carrier

ART. **F22 PA 07A211 00 ZZ**  
2110 mm - Ø 160 mm  
**F22 PA 07A324 00 ZZ**  
3240 mm - Ø 160 mm

\* Ohne Blinklicht  
\* Warning light not included



- Rohrträger aus stabilisiertem PVC
- Stabilised PVC tube carrier

ART. **F22 UP 070200 00 2V**  
2115 mm - Ø 160 mm  
**F22 UP 070210 00 2V**  
2115 mm - Ø 200 mm  
**F22 UP 070220 00 2V**  
3050 mm - Ø 160 mm  
**F22 UP 070230 00 2V**  
3050 mm - Ø 200 mm



- Verstärkung für Traverse
- Bar reinforcement

ART. **F22 UP 070110 00 ZZ**  
1160 mm  
**F22 UP 070120 00 ZZ**  
1360 mm  
**F22 UP 070130 00 ZZ**  
1460 mm  
**F22 UP 070140 00 ZZ**  
1560 mm  
**F22 UP 070150 00 ZZ**  
1660 mm  
**F22 UP 070160 00 ZZ**  
1760 mm

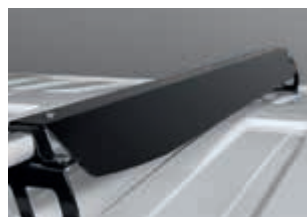

- Spoiler
- Spoiler

ART. **F22 UP 050850 00 07**  
850 mm  
**F22 UP 050950 00 07**  
950 mm  
**F22 UP 051100 00 07**  
1100 mm



FAHRZEUG VEHICLE	LEITERTRÄGER LADDER RACK	ABMESSUNGEN DIMENSIONS	GEWICHT WEIGHT	TRAGKRAFT LOAD CAPACITY
	ART.			
Fahrzeugtyp - Model L1 H1 · 3000 H1	<b>F22 KK DA10H1 L1 00</b>	2900x1680 mm	59,50 kg	140,50 kg
Fahrzeugtyp - Model L2 H1 · 3520 H1	<b>F22 KK DA20H1 L1 00</b>	3550x1700 mm	67,00 kg	133,00 kg
Fahrzeugtyp - Model L2 H2 · 3520 H2	<b>F22 KK DA20H2 L1 00</b>	3550x1600 mm	70,50 kg	129,50 kg
Fahrzeugtyp - Model L2L H2 · 3520L H2	<b>F22 KK DA2LH2 L1 00</b>	3550x1600 mm	70,50 kg	129,50 kg

- Nur für Fahrzeug mit Heckflügeltüren. Der Leiterträger kann links oder rechts montiert werden.
- Only for vehicle with rear leaf doors. The ladder rack rail can be mounted on the right or left side.

**LEITERTRÄGER - LADDER RACK**

- Leiterträger bestehend aus:
  - Alu-Querschienen inkl. Befestigungen und Gummiprofilen
  - Seitenwand aus Aluminium
  - Laderolle aus Aluminium
  - Leiterschiene aus Aluminium und Edelstahl
  - Schraubmaterial aus Edelstahl
- Ladder Rack complete of:
  - aluminium crossbars with fixing parts and rubber profile
  - aluminium side rail
  - aluminium loading roller
  - ladder rack rail made of aluminium and stainless steel
  - fixing screws in stainless steel





Der Montage ist nicht inkludiert  
Assembly is not included

\*\* Anpassbar für Seitenwände in jeder Länge  
\*\* Adaptable to any side barrier length



- Set Funkfernsteuerung max. 10 A und Fernbedienung für LED-Leuchte
- MAX 10 A radio remote control kit and remote control for LED light

ART. **F22 UP 070510 00 00**

- Set Funkfernsteuerung max. 24 A und Fernbedienung für LED-Leuchte
- MAX 24 A radio remote control kit and remote control for LED light

ART. **F22 UP 070520 00 00**

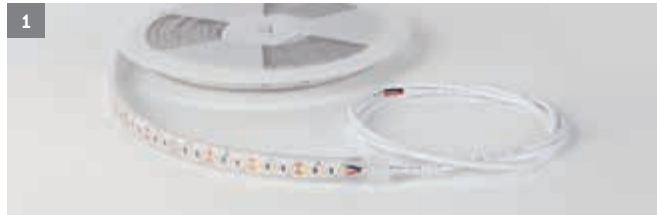

- LED-Leuchtbstreifen mit doppeltem Kabel
- LED strip with double cable

ART.

**F22 UP 070530 00 13**  
Oranges Licht  
Orange light  
4100 mm\*\*

**F22 UP 070530 00 13**  
Weißes Licht  
White light  
4100 mm\*\*

- LED-Leuchtbstreifen mit Kabel
- LED strip with cable

ART.

**F22 UP 070540 00 13**  
Weißes Licht  
White light  
3400 mm\*\*

**F22 UP 070550 00 13**  
Weißes Licht  
White light  
2750 mm\*\*

**F22 UP 070560 00 13**  
Weißes Licht  
White light  
2000 mm\*\*



- Opales Streuprofil aus Polycarbonat für LED-Leuchte
- Opal polycarbonate diffuser profile for LED light

ART.

**F22 UP 070410 00 00**  
3000 mm\*\*

**F22 UP 070420 00 00**  
4700 mm\*\*



- Fester Rundhaltebügel Leiter
- Ladder locking fixed arch

ART. **F22 UP 070300 00 07**

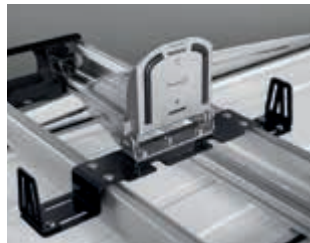

- Klappbarer Rundhaltebügel Leiter
- Ladder locking collapsible arch

ART. **F22 UP 070310 00 07**

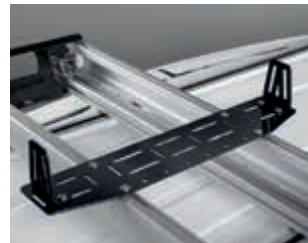

- Universal-Befestigungsplatte
- Universal fixing plate

ART. **F22 UP 070320 00 07**



- Verlängerung
- Extension

ART. **F22 UP 070330 00 07**



- Set Gasfedern
- Gas spring kit

ART.

**F22 UP 070340 00 00**  
30 daN

**F22 UP 070350 00 00**  
70 daN



- Satz Sicherheitsschloss Leiter
- Ladder lock kit

ART. **F22 UP 070450 00 ZZ**





ART. **F22 KT PAP265 00 01**

- Papierrollenhalter mit Papierrolle Ø 130 mm
- Paper towel holder kit with paper towel Ø 130 mm



ART. **F22 KT CAB220 00 01**

- Schlauchhalter
- Cable saddle



ART. **F22 KT SPR365 00 01**

- Spraydosenshalter T=365 mm
- Spray-can holder kit D=365 mm



ART. **F22 KT PAP365 00 01**

- Papierrollenhalter mit Papierrolle Ø 240 mm
- Paper towel holder kit with paper towel Ø 240 mm



ART. **F22 KT CAB296 00 01**

- Schlauchhalter-Satz
- Cable saddle-kit



ART. **F22 KT SIL296 00 01**

- Kartuschen - Spraydosenshalter
- Kit silicone - spray cans holder



ART. **F22 KT AID265 00 01**

- Verbandkasten
- First aid kit



ART. **F22 KT DOC365 00 01**

- Plantasche A4 - 362x68x209 mm H
- A4 documents holder - 362x68x209 mm H



ART. **F22 KT SPR160 00 01**

- Satz 2-Stellen Spraydosenshalter
- Spray-can holder kit [2 slots]



ART. **F22 KT WAS000 00 00**

- Behälter mit Feuchttüchern
- Workshop wipes tub



ART. **F22 KT REC365 00 01**

- Set Haltebügel für Behälter
- Workshop wipes holder kit



ART. **F22 KT WAS365 00 01**

- Handwasch Kit
- Hand wash kit

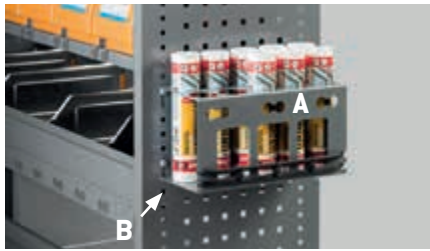
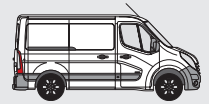

Kartuschenhalter  
Kit silicone holder

A + B

ART. **F22 KT BAR296 00 01** A

- Träger für Silikon-Kartuschen- / Gewindestangenhalter
- Support for silicone cartridges / threaded-bar holder

ART. **F22 KT BAR296 02 01** B

- Adapter für Silikon-Kartuschen
- Adapter for silicone cartridges

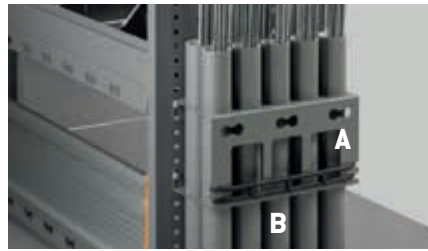

Gewindestangenhalter-Satz  
Threaded-bar holder kit

A + B

ART. **F22 KT BAR296 00 01** A

- Träger für Silikon-Kartuschen- / Gewindestangenhalter
- Support for silicone cartridges / threaded-bar holder

ART. **F22 KT BAR296 01 01** B

- 5 Rohren für Gewindestangenhalter
- 5 Pipe for threaded-bar holder

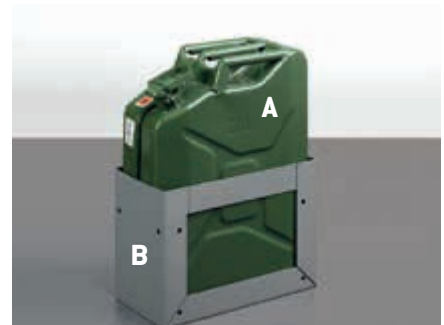

ART. **F22 KT OIL20L 00 00** A

- Stahlkanister inhalt 20 LT
- Metal can capacity 20 LT

ART. **F22 KT OIL365 00 01** B

- Kanisterhalter
- Can holder



ART. **F22 FA BL7433 00 01** A

- Behälterschiene für 1 Behälter gröÙe 1PL
- Container rail for 1 container size 1PL

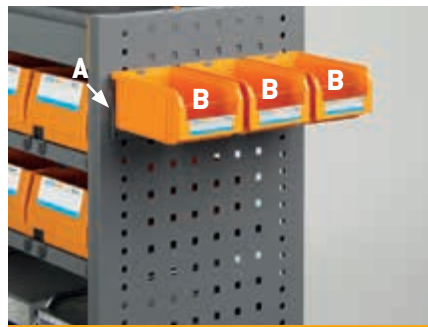

ART. **F22 FA BL7434 00 01** A

- Behälterschiene für 3 Behältern gröÙe 1PL
- Container rail for 3 containers size 1PL

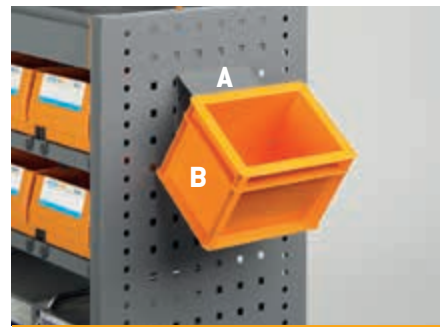

ART. **F22 FA BL7432 00 01** A

- Behälterschiene für 1 Behälter Euro Box
- Container rail for 1 container Euro Box

ART. **F22 FA PM1751 00 25** B

- Kunststoffbehälter gröÙe 1PL
- Polypropylene container size 1PL

ART. **F22 FA PM1751 00 25** B

- Kunststoffbehälter gröÙe 1PL
- Polypropylene container size 1PL

ART. **F22 FA PA2251 A0 25** B

- Kunststoffkasten aus Polypropilen serie Euro Box
- Polypropilene boxes series Euro Box



ART. **F22 KT MAG020 00 00**

- Magnetensatz 10 Stk Ø 20 mm
- Set of 10 magnets Ø 20 mm



ART. **F22 KT RUB160 00 01**

- Halter für Ladungssicherungspads  
158x50x171 mm H
- Non-slip mats holder - 158x50x171 mm H



**ANWENDUNGSBEISPIEL FÜR SATZ LADUNGSSICHERUNGSPADS**

Die Antirutschmatten ermöglichen den Reibungswert bis zu  $\mu_D$  0.6 nach DIN EN 12195-1: 2004 und VDI 2700 ff zu erhöhen. Das Messverfahren befolgt die Richtlinie „VDI 2700 - 15“.

ART. **F22 KT MAG025 00 00**

- Magnetensatz 10 Stk Ø 25 mm
- Set of 10 magnets Ø 25 mm

ART. **F22 KT RUB000 00 07**

- Satz 6 Ladungssicherungspads - 150x150x3 mm H
- 6 non-slip mats kit - 150x150x3 mm H

**USE CASE FOR NON-SLIP MAT**

Non-slip mats are used to increase the coefficient of friction up to  $\mu_D$  0.6 following the calculus DIN EN 12195-1: 2004 and VDI 2700 ff. The measuring procedure should follow the directive "VDI 2700 - 15"





ART. **F22 KT VAL365 00 01**

- Set Halter für Koffer Box 080
- Box 080 tool case holder kit



ART. **F22 KT ORG000 00 39**

- Beifahrersitz-Organizer
- Passenger seat organizer



ART. **F22 WW MOBILE 10 00**

- Klapptisch Work Wood - 980x423x802 mm H
- Table with folding legs - 980x423x802 mm H



ART. **F22 KT DIS000 00 01**

- Umkehrbarer Spenderhalter
- Reversible dispenser holder



ART. **F22 KT GLV000 00 01**

- Einweghandschuhspender
- Disposable glove dispenser



ART. **F22 KT LED001 00 00**

- Led Lampe IP20 12V B=600 mm
- Led lamp IP20 12V W=600 mm



ART. **F22 SB OOROLL SU 01** A

- Schienenträgern-Satz für STORE BOX ROLL
- Set of supports for STORE BOX ROLL

ART. **F22 SB OOROLL 00 08** B

- Plattform mit Rollen mit Bremsen für Koffer BOX 102-136-238-374
- Trolley with castors with brakes for tool case BOX 102-136-238-374





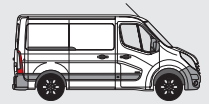

ART. **F22 KT FIR000 00 01** A

- Gasflaschenhalter
- Gas cylinder kit



ART. **F22 FC V18029 03 00** A

- Horizontale Lasthalteschiene mit medium Lochung B=365 mm
- Horizontal load restraining bar with medium hole connector W=365 mm

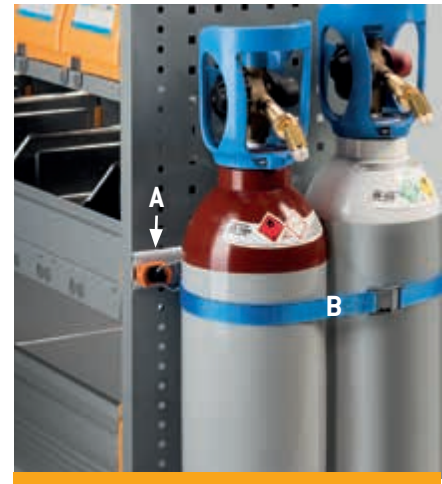

ART. **F22 FC V18029 03 00** A

- Horizontale Lasthalteschiene mit medium Lochung B=365 mm
- Horizontal load restraining bar with medium hole connector W=365 mm



ART. **F22 KT FIR4KG 00 00** B

- Feuerloescher (Pulver) 4 KG
- Fire extinguisher (powder) 4 KG



ART. **F22 FC V18029 04 00** A

- Horizontale Lasthalteschiene mit medium Lochung B=445 mm
- Horizontal load restraining bar with medium hole connector W=445 mm



ART. **F22 FC V18029 04 00** A

- Horizontale Lasthalteschiene mit medium Lochung B=445 mm
- Horizontal load restraining bar with medium hole connector W=445 mm



ART. **F22 FC V22868 00 00** B

- Zurrgurte mit Ratschenschloss mit medium Anschlussstiel
- Medium connector ratchet load restraining belt



ART. **F22 FC V22869 00 00** B

- Zurrgurte mit Hebelspannschloss mit medium Anschlussstiel
- Medium connector clamp load restraining belt

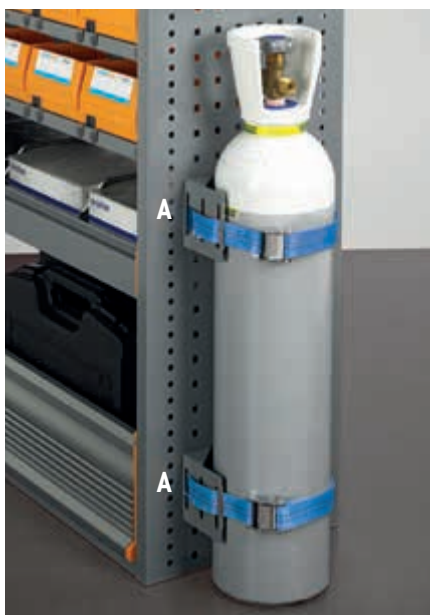

Beispiel mit  
2 ART. F22 KT FIR000 00 01  
Example with  
2 ART. F22 KT FIR000 00 01

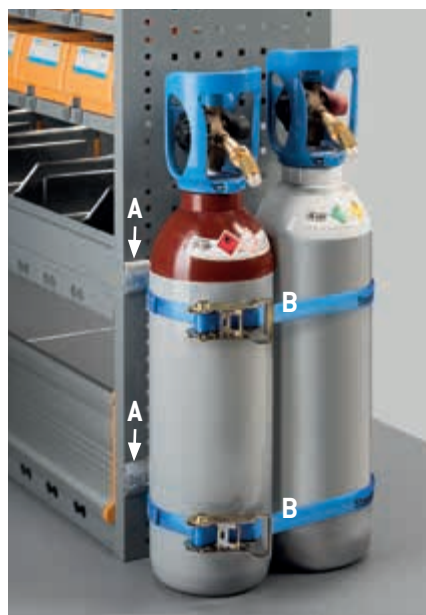

Beispiel mit  
2 ART. F22 FC V18029 03 00  
2 ART. F22 FC V22868 00 00  
Example with  
2 ART. F22 FC V18029 03 00  
2 ART. F22 FC V22868 00 00

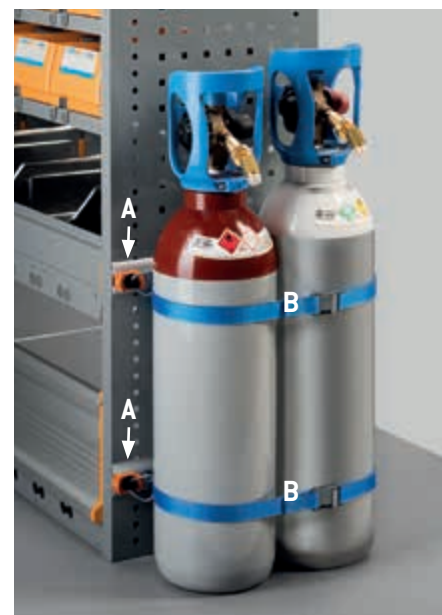

Beispiel mit  
2 ART. F22 FC V18029 03 00  
2 ART. F22 FC V22869 00 00  
Example with  
2 ART. F22 FC V18029 03 00  
2 ART. F22 FC V22869 00 00

# IVECO DAILY

## LIEFERBEDINGUNGEN

- Bodenplatten und Seitenverkleidungen werden in mehreren Teilen geliefert.
- Dachträger und Leiterträger werden **lose** geliefert.
- Module werden **vormontiert** komplett mit Fahrzeugbefestigungsmaterial geliefert.
- Produkte sollen vorzugsweise von **Vertragshändlern** installiert werden.
- Produkte werden **verpackt** geliefert.
- **5 Jahre Garantie** auf unsere Komponenten.
- Die Tragkräfte beziehen sich auf **gleichmäßig verteilte Last**.



## SUPPLY CONDITIONS

- Flooring and linings supplied in several pieces.
- Roof and ladder racks supplied **flat-packed**.
- Modules are supplied **preassembled** complete of fixing material to the vehicle.
- For products installation, please get in touch with our **approved installer's network**.
- Products provided **with packaging**.
- Our products are covered by a **5-years warranty**.
- Load capacities refer to **uniformly distributed loads**.



### FAMI S.R.L.

VIA STAZIONE ROSSANO, 13 – 36027 ROSÀ (VI) ITALY  
TEL +39 0424 585455 R.A. – FAX +39 0424 585482  
INFO@FAMISPA.COM – WWW.FAMISPA.COM

INFO@STOREVAN.COM – WWW.STOREVAN.COM

