

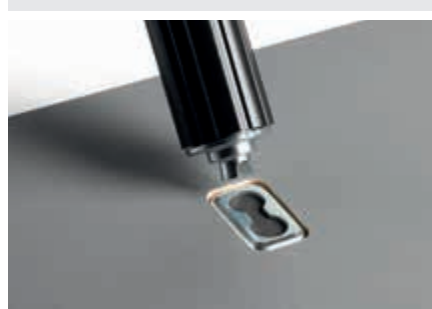

BEDRIJFSWAGENINRICHTINGEN
FITTINGS FOR COMMERCIAL VEHICLES



CITROËN BERLINGO





StoreVan is wereldwijd de enige fabrikant van bedrijfswageninrichtingen, die met deze technologie werkt.

StoreVan is the sole LCV's equipment manufacturer worldwide to make use of this technology.

TECHNOLOGIE

GEALVANISEERD STAAL

Het product wordt onder verhitting tot ca. 550 °C voorzien van een zinklaag. Daardoor ontstaat er een legering tussen blik en zink. Dat resulteert in een laag met een evenwichtige, fijne kristalstructuur en een **zeer hoge oppervlakte kwaliteit en corrosiebestendigheid**. Dit procedé is ideaal voor automotieve toepassingen. StoreVan heeft deze techniek nu ook voor haar bedrijfswageninrichtingen geïmplementeerd.

HET PROCES VAN HET KATHODISCHE ACRYL DOMPELBAD VERFSYSTEEM

De kathodische Acryl-afwerking is een oppervlakte behandeling, die de diverse onderdelen van de inrichting een **extreem hoge corrosiebestendigheid** bezorgt. De dompelbad techniek, die ook in de auto-industrie wordt toegepast, garandeert een **gelijkmatige laagdikte** en een langdurige bescherming tegen alle mogelijke stoffen. De Acrylhars beschermt de lak tegen uitbleken door weersinvloeden en is slagvast en daarmee blijvend corrosiebestendig.

- Corrosiebestendigheid meer dan 500 uur (ASTM D1735 luchtvochtigheid)
- Uitstekende hardheid met tenminste een rating van 2H



STORE VAN ORANGE PLANET

Duurzaamheid en ecologische ontwikkelingen zijn thema's van groot, actueel belang, ontstaan door het toenemende bewustzijn, dat het milieu door cyclische veranderingen en vernieuwingen in balans moet blijven.

STORE VAN ORANGE PLANET

Environmental sustainability and eco-compatible development are topics of great interest and relevance, arising from the growing awareness that it is important to pay attention to the environmental balance.

TECHNOLOGIES

GALVANNEALED STEEL

Galvannealed sheet is a variant of hot-dip galvanized sheet. The product is subject to a hot-dip galvanization process and subsequently heated to approximately 550°C, combining the zinc with the sheet surface to make an alloy with iron. The result is a uniform zinc coating with a fine-grained crystalline structure along with a **much higher surface quality and corrosion resistance**. This process is ideal for automotive applications. StoreVan has introduced and implemented this technology in the commercial vehicles equipment field.

CATHODIC DIP PAINTING WITH ACRYLIC RESIN

Cataphoresis painting is a paint surface treatment able to give the equipment elements a **remarkable resistance to corrosion**; characterized by **uniform deposit** of an acrylic resin on the element surface, it ensures long lasting, high protection against chemical agents and other types of surface attacks. The acrylic resin allows a direct exposure to atmospheric agents without altering its technical features. This process ensures an increased protection against rust.

- Corrosion resistance of more than 500 hours (humidity ASTM D1735)
- Excellent hardness with a minimum rating of 2H



FLEXIBEL BEVESTIGINGSSYSTEEM

FLEXIBLE FIXING SYSTEM

FLEXIBILITEIT EN DUURZAAMHEID VAN STOREVAN MATERIAAL

StoreVan maakt gebruik van een speciaal bevestigingssysteem om modules voor bedrijfswagens aan het chassis van het voertuig te bevestigen. Daardoor wordt de flexibiliteit van de module-opstelling verbeterd. De zijwanden van de modules hebben een tweevoudige functie: zij verbinden schap-eenheden op uniforme wijze met de carrosserie van het voertuig én verdelen gelijkmatig alle dynamische krachten in uw bedrijfswagen, die tijdens het rijden optreden.

Speciale trillingsdempende verbindingsbeugels absorberen de torsiekrachten die door het chassis worden veroorzaakt, vooral in bochten. Dankzij dit systeem kunnen onze bevestigingen voor bedrijfswagens overal worden toegepast, waarbij hoge veiligheids-, stabiliteits- en duurzaamheidsnormen altijd worden gegarandeerd.

FLEXIBILITY AND DURABILITY OF STORE VAN EQUIPMENT

Store Van uses a special rail anchoring system to secure shelving units for vans to the chassis of your vehicle, improving the flexibility of module arrangement and maximising the internal spaces of your van.

This system is based on brackets sliding all along the rail rather than being riveted to chassis reinforcements, thus offering great flexibility in the management of internal spaces. The Store Van rail is secured to the uprights of your mobile workshop and has a two-fold function: it connects shelving units uniformly to the frame of your vehicle, and it evenly distributes all the dynamic forces your van equipment is subject to while travelling.

Special vibration damping joints, fitted on the brackets connecting the rail to the module, absorb the torsional vibration applied on the chassis especially when driving on a curve.

Thanks to this system, our fittings for vans can be designed with maximum freedom, always ensuring high safety, stability and durability standards.

Onze verankeringsystemen zijn uitgerust met snel-verbindingen, zodat u als gebruiker de modules kunt verwijderen zonder gereedschap. Vandaar dat de modules van uw mobiele werkplaats kunnen worden beschouwd als vervoerde goederen of ladingbevestigingshulpstukken die niet permanent aan het voertuig zijn bevestigd, in overeenstemming met Richtlijn 2014/47EU, hoofdstuk 1, artikel 3, item 5.

Our anchoring systems are fitted with quick locking/unlocking devices with adjustable handles, so users can remove the fittings with no need of tools. Hence the shelving units of your mobile workshop may be considered as transported goods or load securing fittings not permanently fixed to the vehicle, in compliance with Directive 2014/47EU, Chapter 1, Article 3, Item 5.



CERTIFICERINGEN CERTIFICATIONS

GECEERTIFICEERDE PRODUCTIE

- ISO 9001: 2015 gecertificeerd.
- Succesvolle CRASH TEST volgens ECE-R17 met een snelheid van 50 km/u.
- GS-Certificaat voor de laadplatforms en inrichtingen.
- GS-Certificaat voor imperiaal en ladderdrager.

CERTIFIED PRODUCTION

- ISO 9001:2015 certified.
- Brilliantly passed the CRASH TEST carried out according to the most recent European regulations ECE-R17 with impact at 50 Km/h.
- GS certification for interior fittings and loading ramps.
- GS certification for roof and ladder racks.

CRASH TEST
ECE-R17



De basis voor de veilige bescherming van voertuigen

The basis for the safe protection of vehicles



LADINGBEVEILIGING EN -ZEKERING

De invoering van Richtlijn 2014/47/EU zal de controle op voertuigen van de categorie N2 en N3 en de handhaving van de ladingbeveiligingssystemen intensiveren. Krachtens deze richtlijn kunnen de lidstaten voertuigen die buiten het toepassingsgebied van de richtlijn vallen, zoals voertuigen van de categorie N1, onderwerpen aan technische inspecties.

LADINGBEVEILIGING EN LADINGZEKERING

Het nieuwe geïntegreerde systeem van StoreVan volgt de richtlijnen van Richtlijn 2014/47/EU, terwijl de **verankering van de lading aan de vloer en wanden van de bedrijfswagen flexibel en veilig is.**

Met de toepassing van 'Airline' bevestigingscomponenten en gebruik van veel verschillende accessoires, zoals sjoorbanden, netten en telescopische laadbeugels, kunnen eindgebruikers hun laadruimte gemakkelijk en goedkoop configureren.

Het systeem gebruikt:

- Multiplex watervast verlijmd vloerplaten met speciale phenol coating, geschikt voor de reeds bestaande sjoorog bevestigingen en met extra 200 daN sterke verzonken bevestigingspunten (pagina 10);
- Aluminium 'Airline' rails verankerd aan het chassis (pagina 11);
- Zeer flexibele en sterke polypropyleen honingraat panelen om de binnenzijde van de laadruimte te beschermen tegen onbedoelde beschadigingen (pagina 8).

VOORDELEN VAN HET NIEUWE LAADBEVEILIGINGSSYSTEEM:

- Gebruikers kunnen de lading veilig met sjoorbanden aan de 'Airline'-rails bevestigen;
- Door het geïntegreerde ladingbeveiligingssysteem houdt men de laadruimte langer netjes;
- Zowel nieuwe als oudere voertuigen behouden langer hun waarde, doordat de laadruimte minder beschadigingen oploopt tijdens het gebruik.



VAN LOAD SECURING AND CARGO RESTRAINT

Transposition of directive 2014/47/EU will intensify control of N2 and N3 category transport vehicles and cargo securement enforcement. Under this Directive, the Member States can subject vehicles that are beyond the scope of the Directive, such as N1 category vehicles, to technical inspections, and also monitor other transport and road safety aspects.

CARGO AREA PROTECTION SYSTEM AND CARGO RESTRAINT

The new Store Van integrated system for van protection follows the guidelines of Directive 2014/47/EU while making the **anchoring of the cargo to the van floor and walls flexible and safe.**

With the use of "Airline" securing components and integration of many different accessories such as belts, nets and telescopic load restraining bars, final users may configure their cargo platform easily and cheaply and in conformity with the European Directive.

The system uses:

- phenolic resin plywood floor panels, arranged to fit original anchoring fittings and additional 200 daN strength lashing points (page 10), flush with the floor panel;
- aluminium "Airline" bars anchored to the chassis (page 11);
- highly flexible and resistant polypropylene panelling to protect the internal body shell from accidental impacts (page 8).

THE NEW LOAD SECURING SYSTEM OFFERS NUMEROUS ADVANTAGES:

- users can safely secure the load to the "Airline" bars with load restraining belts;
- the integrated load securing system extends the body's good condition over the time;
- the protection system offers new added value, an important economic aspect for a new vehicle and a fundamental characteristic for a second-hand vehicle, that is usually exposed to damage.

SAFETY CROSS: Bevestigingspunten in lengterichting en dwarsrichting op aanvraag.
SAFETY CROSS: longitudinal and transversal fixing points upon request.

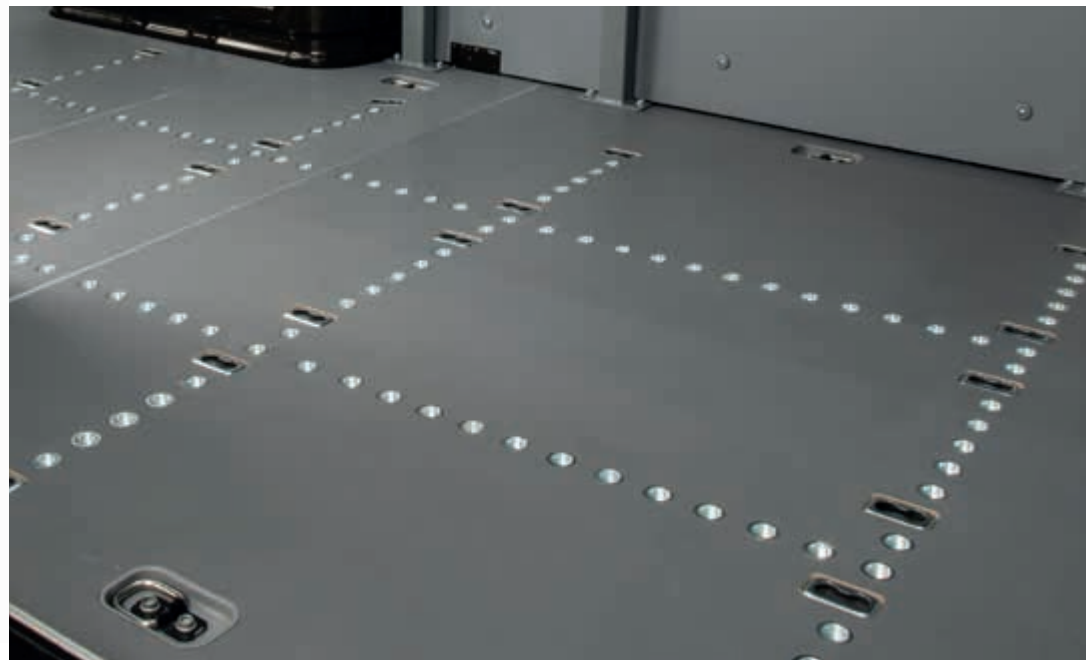

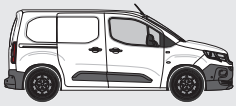

- Zijwandbekledingen voor een voertuig met rechter schuifdeur en stalen zijwanden.
- Linings for right side door vehicle with metal sheet sidewalls.



HONEYCOMB PANEL - A

- Wandbekleding uit polypropyleen voor:
 - linker zijwand
 - rechter zijwand en schuifdeur

- Polypropylene linings for:
 - LH sidewall
 - RH sidewall and sliding door

HONEYCOMB PANEL - C

- Seitenverkleidung aus Polypropylen für:
 - oberen Teil der Heckflügeltüren

- Wandbekleding uit polypropyleen voor:
 - bovenste deel achterdeuren

VOERTUIG VEHICLE	WANDBEKLEDING LINING	
	A	C
	ART. NR. / ITEM NO.	ART. NR. / ITEM NO.
Voertuigtype - Model L1 H1	PA 10H1 A1 3,35 kg	PA DRH1 A0 0,97 kg
Voertuigtype - Model L2 H1	PA 20H1 A1 3,97 kg	PA DRH1 A0 0,97 kg



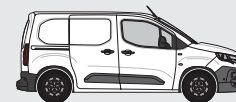

- Bodemplaat voor een voertuig met rechter schuifdeur en stalen zijwanden.
- Flooring for right side door vehicle with metal sheet sidewalls.



WOOD FLOOR - D

- Bodemplaat uit multiplex met fenolbekleding, dikte 9 mm, vorgeboord voor bevestiging d.m.v. de bestaande sjoorogen
- 9 mm thick wooden flooring with phenolic coating set for the vehicle original anchoring system

BEDRIJFSWAGEN - PANEL VAN
CITROËN BERLINGO

WF

VOERTUIG VEHICLE	BODEMPLAAT 9 mm 9 mm FLOORING
	D
	ART. NR. / ITEM NO.
Voertuigtype - Model L1	PA 10D1 B1 14,64 kg
Voertuigtype - Model L2	PA 20D1 B1 17,83 kg



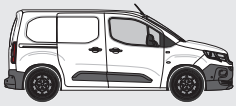

- Bodemplaat voor een voertuig met rechter schuifdeur en stalen zijwanden.
- Flooring for right side door vehicle with metal sheet sidewalls.

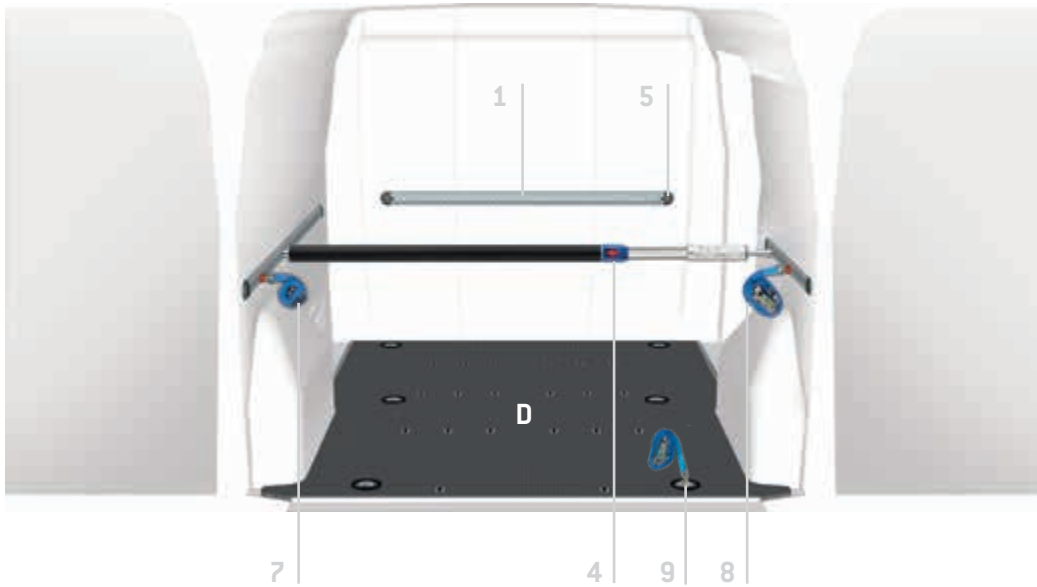

SAFETY FLOOR - D

- Bodemplaat uit multiplex phenolbekleding, dikte 9 mm, met extra sjoerpunten
- 9 mm phenol faced plywood flooring with additional lashing points

VOERTUIG
VEHICLEBODEMPLAAT 9 mm
FLOORING 9 mm

D

ART. NR. / ITEM NO.

Voertuigtype - Model
L1PA 10K1 B1
16,44 kgVoertuigtype - Model
L2PA 20K1 B1
19,82 kg

De vloer dient aan het voertuig te worden gelijmd.
The floor must be glued to the vehicle



- Siliconenlijm voor vloeren.
- Silicone glue for flooring.

ART. NR. / ITEM NO. **V22585**

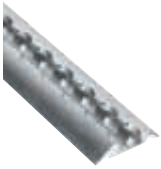
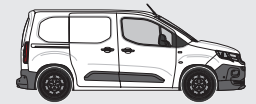

- Horizontale aluminium rail.
- Horizontal aluminium bar.

1

ART. NR. / ITEM NO.

- V18029 05 Lengte - Length 500 mm
- V18029 10 Lengte - Length 1000 mm
- V18029 15 Lengte - Length 1500 mm
- V18029 20 Lengte - Length 2000 mm
- V18029 25 Lengte - Length 2500 mm



- Telescopische spanstang.
- Telescopic load restraining bar.

4

ART. NR. / ITEM NO.

- V22149 Lengte - Length 650-900 mm
- V22734 Lengte - Length 850-1100 mm
- V22735 Lengte - Length 1050-1300 mm
- V22131 Lengte - Length 1250-1750 mm
- V22017 Lengte - Length 1550-2050 mm
- V22086 Lengte - Length 2000-2500 mm



- Eindstop voor rail serie V18029.
- Plastic end cap for bar series V18029.

5

ART. NR. / ITEM NO.

V22106

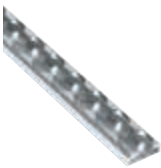

- Horizontale aluminium rail.
- Horizontal aluminium bar.

2

ART. NR. / ITEM NO.

- V18025 05 Lengte - Length 500 mm
- V18025 10 Lengte - Length 1000 mm
- V18025 15 Lengte - Length 1500 mm
- V18025 20 Lengte - Length 2000 mm



- Trekoog.
- Ring stud fitting.

6

ART. NR. / ITEM NO.

V225820



- Sjorband met snapsluiting 2500+500.
- Load restraining belt with clamp 2500+500.

7

ART. NR. / ITEM NO.

V22136



- Eindstop voor rail serie V18025.
- Plastic end cap for bar series V18025.

10

ART. NR. / ITEM NO.

V23389

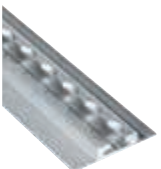

- Horizontale aluminium rail.
- Horizontal aluminium bar.

3

ART. NR. / ITEM NO.

- V18030 10 Lengte - Length 1000 mm
- V18030 15 Lengte - Length 1500 mm
- V18030 20 Lengte - Length 2000 mm
- V18030 25 Lengte - Length 2500 mm
- V18030 30 Lengte - Length 3000 mm



- Sjorband met ratel 2500+500.
- Load restraining belt with ratchet 2500+500.

8

ART. NR. / ITEM NO.

V22124



- Sjorband met ratel 4500+500.
- Load restraining belt with ratchet 4500+500.

9

ART. NR. / ITEM NO.

V22148



- Voorbeeld van gereedschapskoffer met ladingzekering.
- Example of tool case for load securing.



1 ART. NR. / ITEM NO.
BOX080

B=440 T=350 H=80 mm
W=440 D=350 H=80 mm



2 ART. NR. / ITEM NO.
V22136



1 ART. NR. / ITEM NO.
CPV080



2 ART. NR. / ITEM NO.
V22124



4 ART. NR. / ITEM NO.
V225820



2 ART. NR. / ITEM NO.
V22148



1 ART. NR. / ITEM NO.
YELLOW

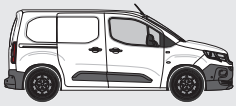

ONDERDELEN WANDBEKLEDING - LININGS LEGEND

CITROËN BERLINGO
BEDRIJFSWAGEN - PANEL VAN

HP
HONEYCOMB
PANEL

- Voor een voertuig met rechter schuifdeur en stalen zijwanden.
- For right side door vehicle with metal sheet sidewalls.

Voertuigtype - Model
L1 H1

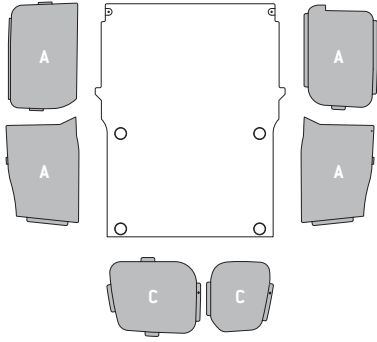

Voertuigtype - Model
L2 H1

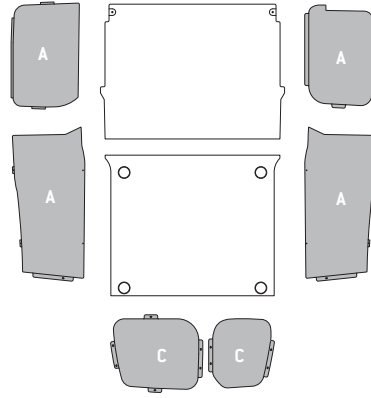

SAFETY CROSS: Bevestigingspunten in lengterichting en dwarsrichting op aanvraag.
SAFETY CROSS: longitudinal and transversal fixing points upon request.

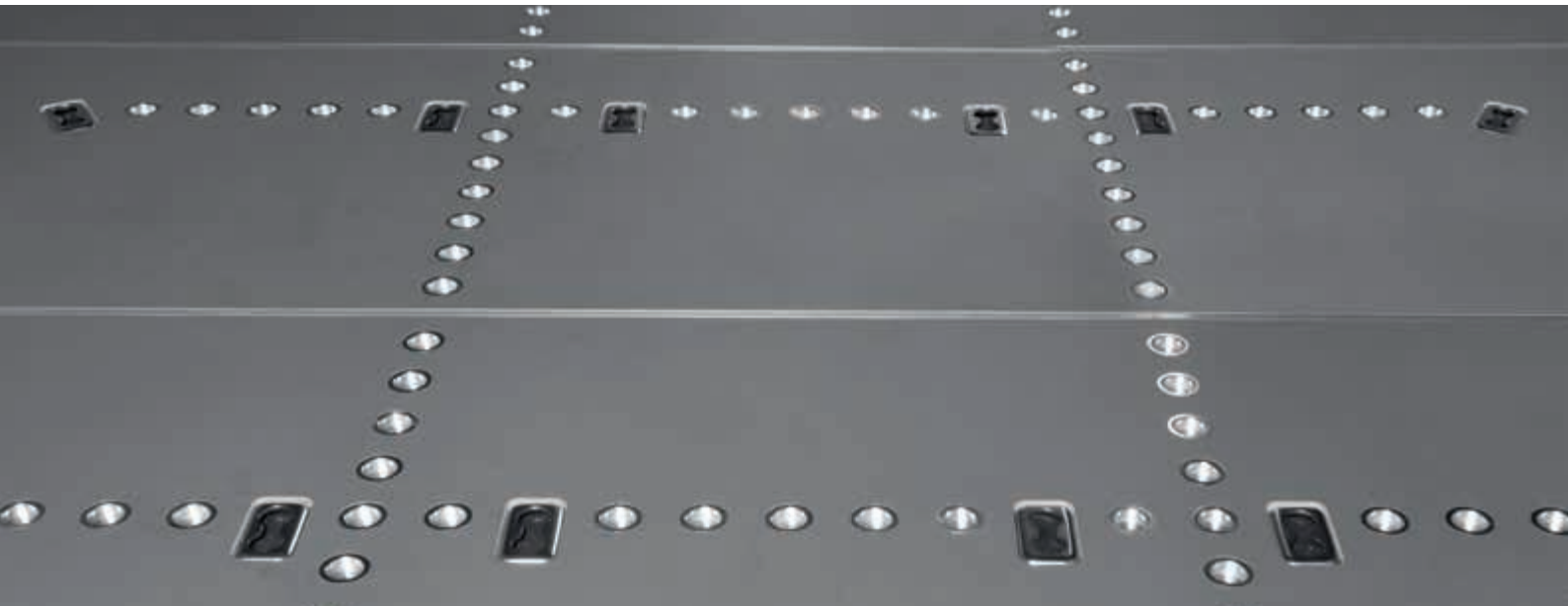

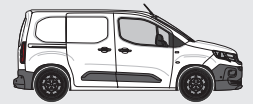

- Voor een voertuig met rechter schuifdeur en stalen zijwanden.
- For right side door vehicle with metal sheet sidewalls.

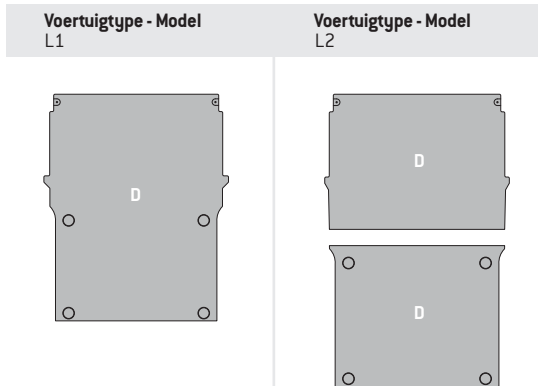

BEDRIJFSWAGEN - PANEL VAN
CITROËN BERLINGO

WOOD
FLOOR
WF

- Voor een voertuig met rechter schuifdeur en stalen zijwanden.
- For right side door vehicle with metal sheet sidewalls.

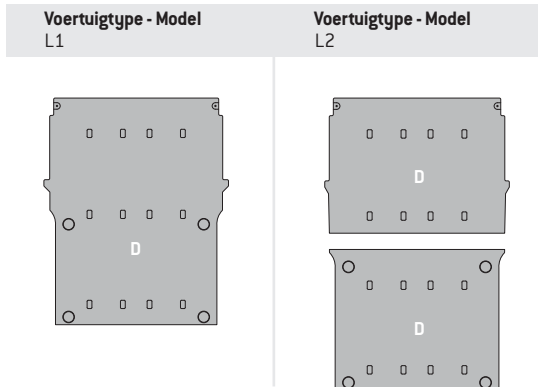

- Elke rij bevestigingspunten van elke bodemplaat bestaat uit 4 'Airline' sjoerpunten.
- In each flooring, each lashing row is composed of 4 "Airline" lashing points.

SAFETY
FLOOR
SF

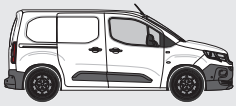

**Standaard met
ladingzekering**

**Factory-fitted load
securing**



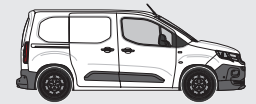

De StoreVan **veilige bedrijfswageninrichtingen** voldoen aan de eisen van de nieuwste ladingbeveiligingsvoorschriften. In de module worden elementen gemonteerd die gebruik van bevestigingssystemen, zoals spanbanden, netten en telescopische spanstangen, mogelijk maken. Dit nieuwe niveau **van inrichtingen voor bedrijfswagens** vergemakkelijkt het verankeren van middelgrote en kleine voorwerpen. Zelfs wanneer de bodemplaat niet met bevestigingssystemen is uitgerust, garandeert het ladingszekeringssysteem veiligheid zonder gewichtstoename van de module, doordat dit in de inrichting is geïntegreerd.

The Store Van **SAFETY equipment solution** meets the requirements of the new cargo restraint regulations. Our modules are integrated with structural elements where "Airline" anchoring fittings, such as belts, nets and telescopic bars can easily fit. This new equipment for commercial vehicles simplifies the securing of medium-sized or small parts, even if the floor panel of your van has no anchoring systems, to guarantee maximum load securing. The "Airline" anchoring fittings for SAFETY equipment improve the stability of modules with no weight increase, because they are built in the equipment structure.



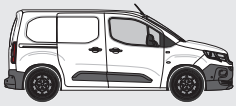

L1 H1

CITROËN BERLINGO
BEDRIJFSWAGEN - PANEL VAN

SAFETY

INRICHTINGSVOORBEELDEN - FITTINGS EXAMPLES

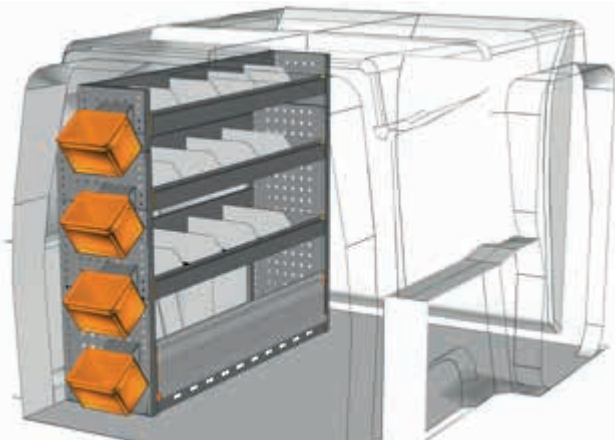

VOORBEELD - EXAMPLE

PA 1211 11*

B=1225 T=365 H=1100 mm - W=1225 D=365 H=1100 mm

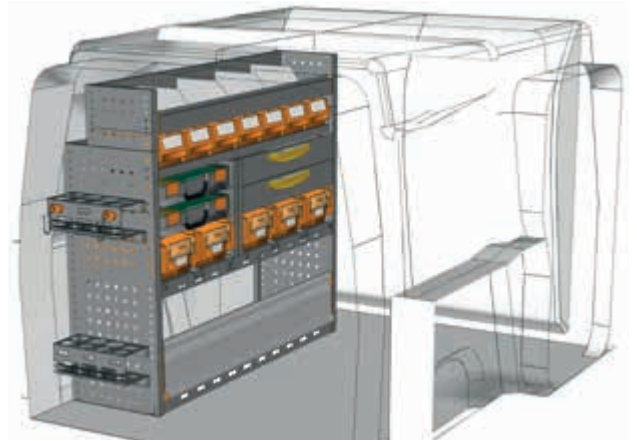
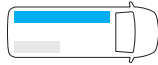

VOORBEELD - EXAMPLE

PA 1211 12*

B=1225 T=365 H=1100 mm - W=1225 D=365 H=1100 mm

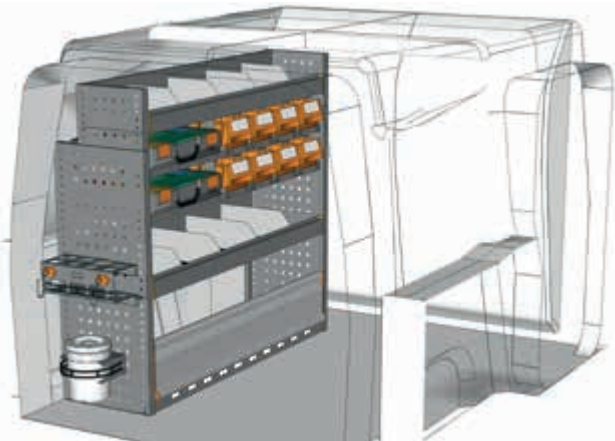
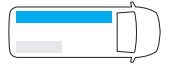

VOORBEELD - EXAMPLE

PA 1211 13*

B=1225 T=365 H=1100 mm - W=1225 D=365 H=1100 mm

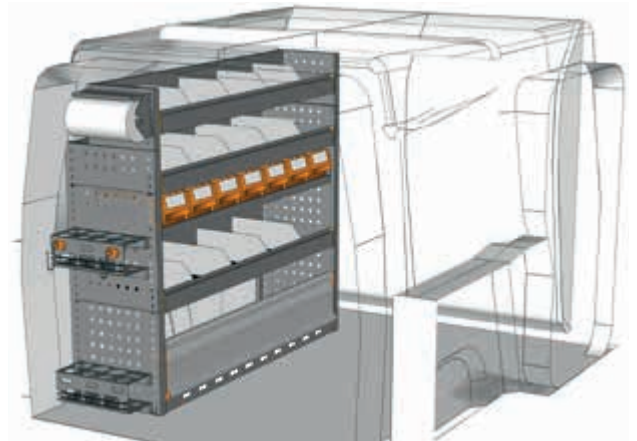
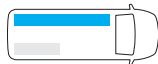

VOORBEELD - EXAMPLE

PA 1211 14*

B=1225 T=365 H=1100 mm - W=1225 D=365 H=1100 mm

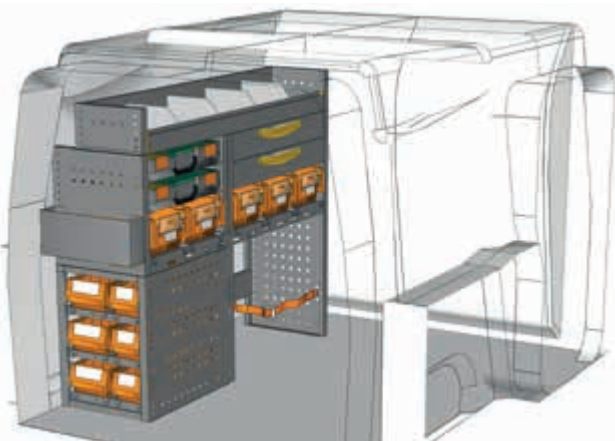

VOORBEELD - EXAMPLE

PA 1211 15*

B=1225 T=365 H=1050 mm - W=1225 D=365 H=1050 mm

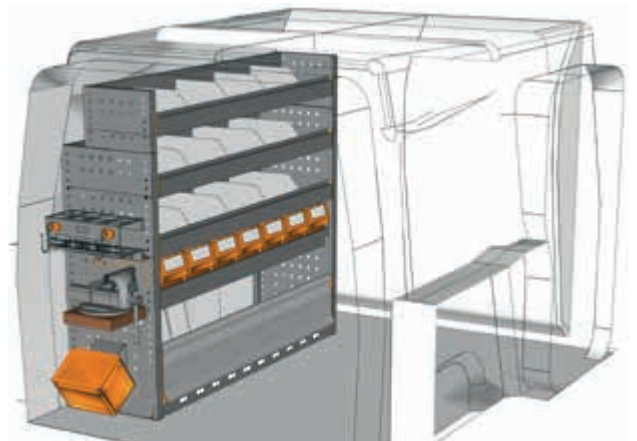
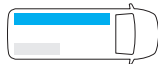

VOORBEELD - EXAMPLE

PA 1211 16*

B=1225 T=365 H=1100 mm - W=1225 D=365 H=1100 mm



* Inclusief bevestigingsmateriaal - Fixing kit included

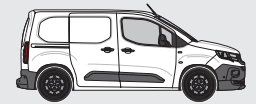

INRICHTINGSVOORBEELDEN - FITTINGS EXAMPLES

BEDRIJFSWAGEN - PANEL VAN
CITROËN BERLINGO

SAFETY

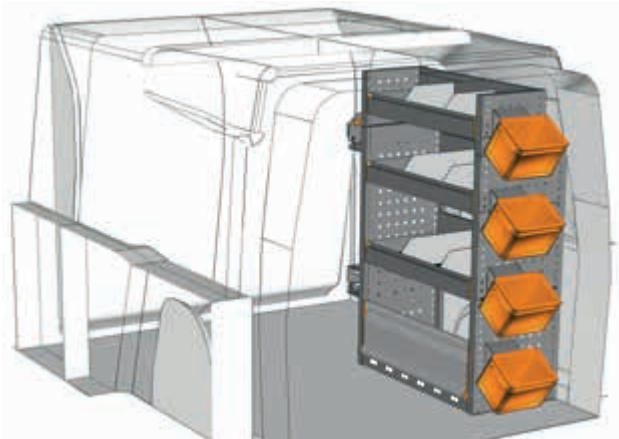

VOORBEELD - EXAMPLE

PA 0711 11*

B=717 T=365 H=1100 mm - W=717 D=365 H=1100 mm

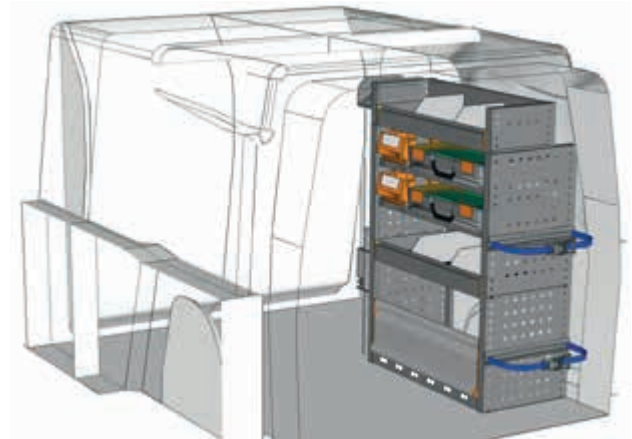
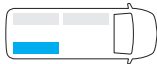

VOORBEELD - EXAMPLE

PA 0711 12*

B=717 T=365 H=1050 mm - W=717 D=365 H=1050 mm

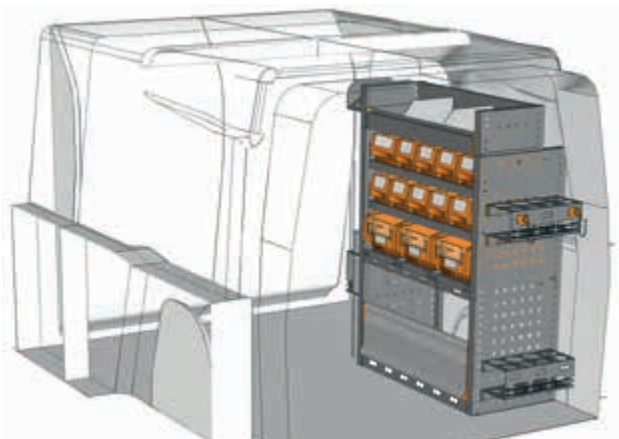
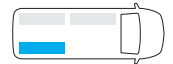

VOORBEELD - EXAMPLE

PA 0711 13*

B=717 T=365 H=1050 mm - W=717 D=365 H=1050 mm

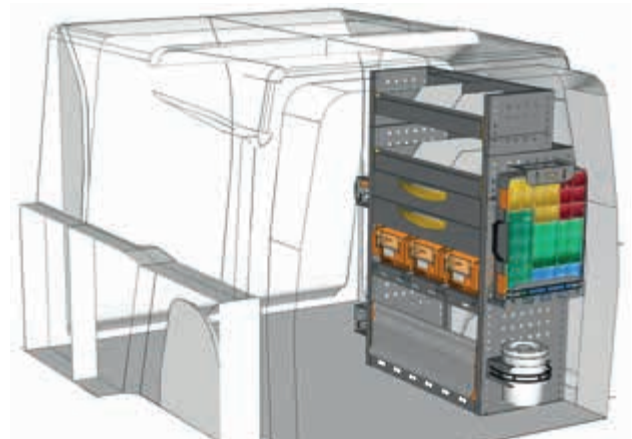

VOORBEELD - EXAMPLE

PA 0711 14*

B=717 T=365 H=1100 mm - W=717 D=365 H=1100 mm

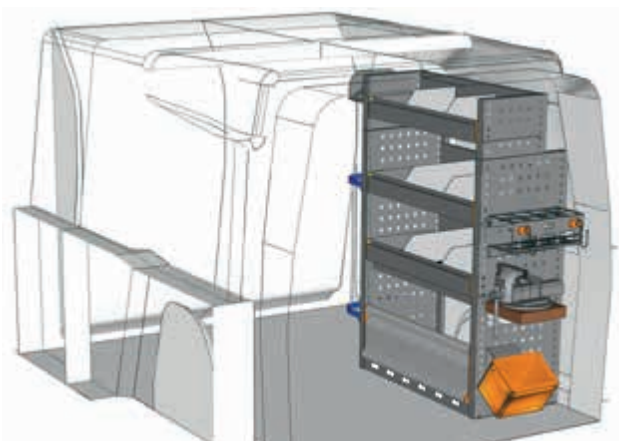
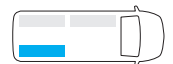

VOORBEELD - EXAMPLE

PA 0711 15*

B=717 T=365 H=1100 mm - W=717 D=365 H=1100 mm

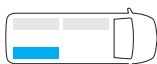

Heeft u uw ideale inrichting niet gevonden?
Voor bedrijfswageninrichtingen op maat neemt u contact op met onze vakmensen.
Op de achterzijde vindt u de adresgegevens of bezoek onze website www.storevannederland.nl

Didn't find the equipment you're looking for?
Leave it to our experts.
See the back of this catalogue and contact the nearest StoreVan point or visit our website.



* Inclusief bevestigingsmateriaal - Fixing kit included

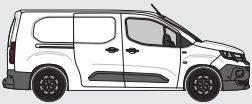

L2 H1

CITROËN BERLINGO
BEDRIJFSWAGEN - PANEL VAN

SAFETY

INRICHTINGSVOORBEELDEN - FITTINGS EXAMPLES

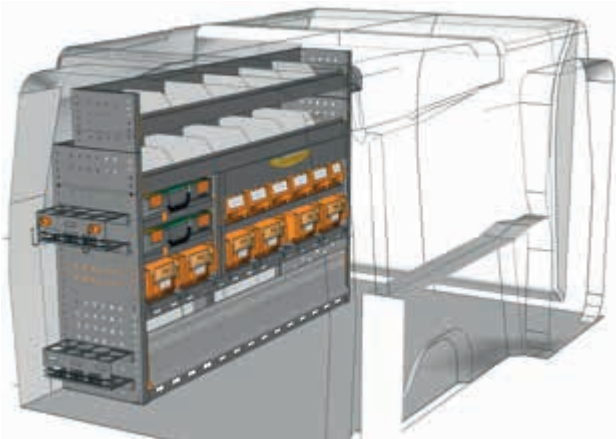

VOORBEELD - EXAMPLE

PA 1511 01*

B=1524 T=365 H=1100 mm - W=1524 D=365 H=1100 mm

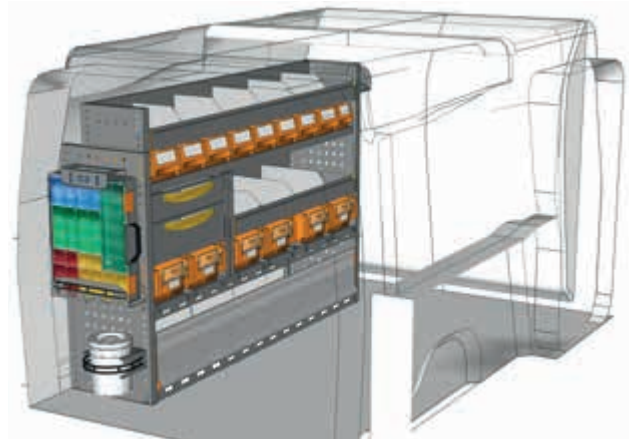
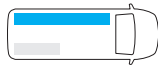

VOORBEELD - EXAMPLE

PA 1511 02*

B=1524 T=365 H=1050 mm - W=1524 D=365 H=1050 mm

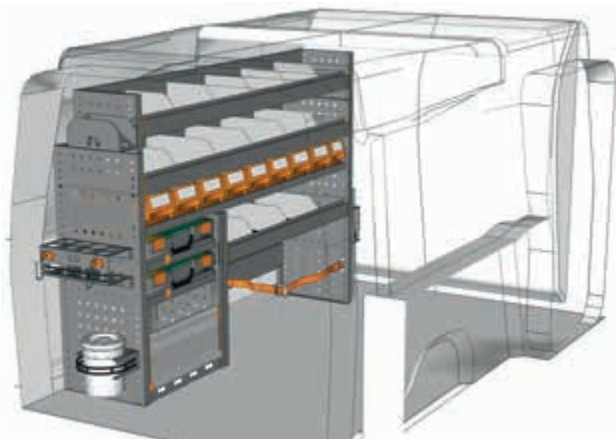
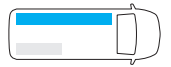

VOORBEELD - EXAMPLE

PA 1511 03*

B=1524 T=365 H=1100 mm - W=1524 D=365 H=1100 mm

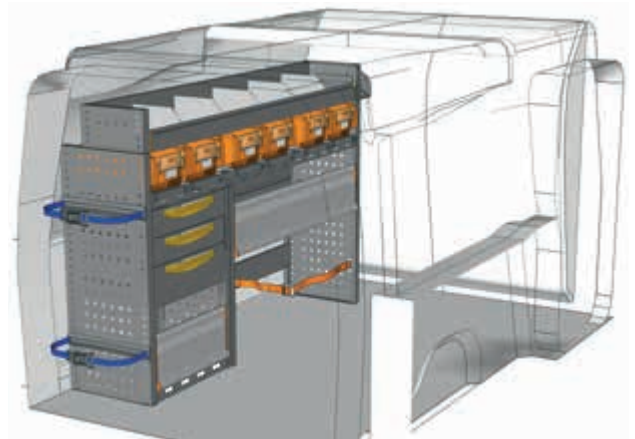
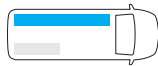

VOORBEELD - EXAMPLE

PA 1511 04*

B=1524 T=365 H=1050 mm - W=1524 D=365 H=1050 mm

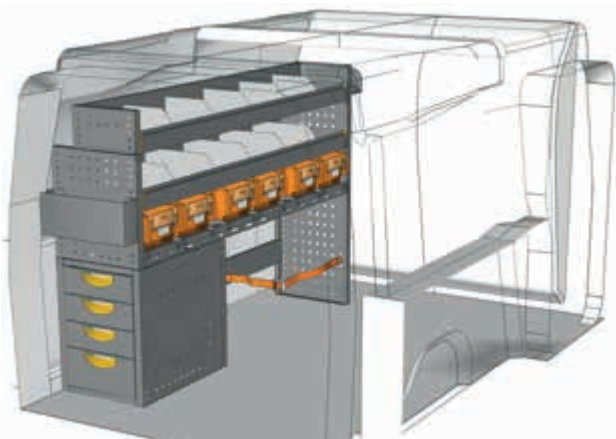
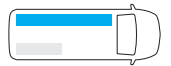

VOORBEELD - EXAMPLE

PA 1511 05*

B=1524 T=365 H=1050 mm - W=1524 D=365 H=1050 mm

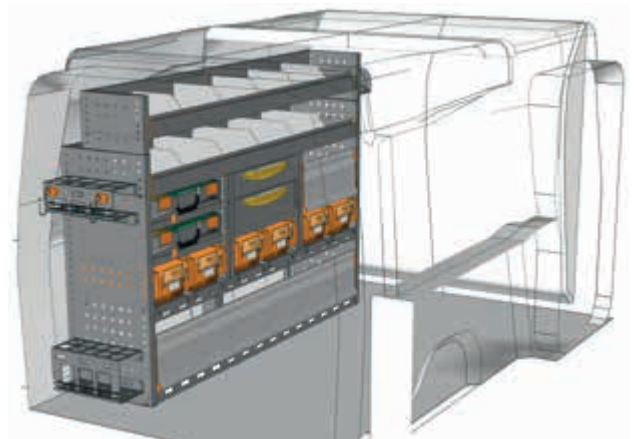
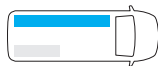

VOORBEELD - EXAMPLE

PA 1511 06*

B=1524 T=365 H=1100 mm - W=1524 D=365 H=1100 mm

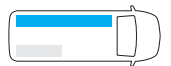

* Inclusief bevestigingsmateriaal - Fixing kit included

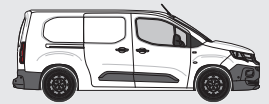

INRICHTINGSVOORBEELDEN - FITTINGS EXAMPLES

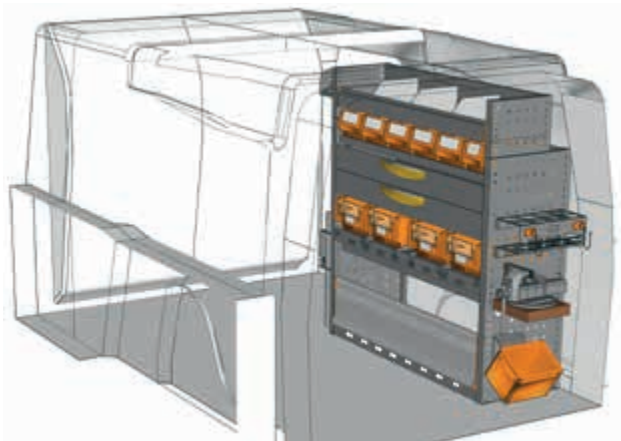

VOORBEELD - EXAMPLE

PA 1011 01*

B=1016 T=365 H=1100 mm - W=1016 D=365 H=1100 mm

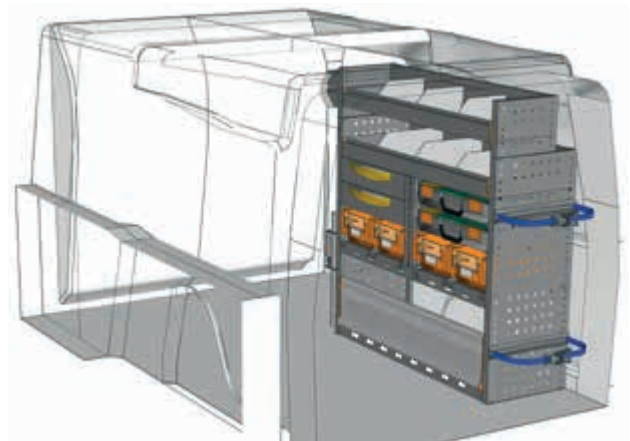
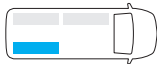

VOORBEELD - EXAMPLE

PA 1011 02*

B=1016 T=365 H=1100 mm - W=1016 D=365 H=1100 mm

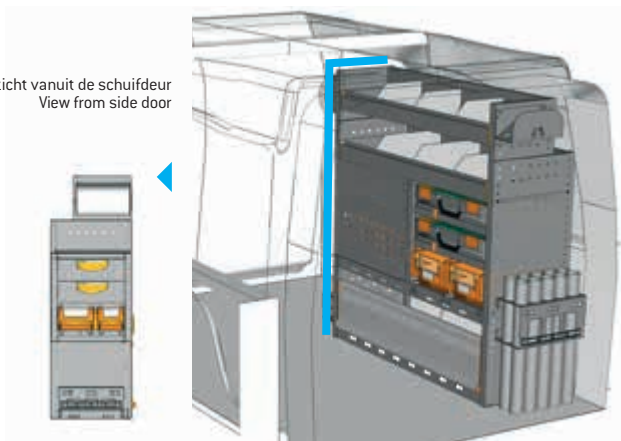
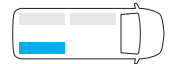

Aanzicht vanuit de schuifdeur
View from side door

VOORBEELD - EXAMPLE

PA 1011 03*

B=1016 T=365 H=1100 mm - W=1016 D=365 H=1100 mm

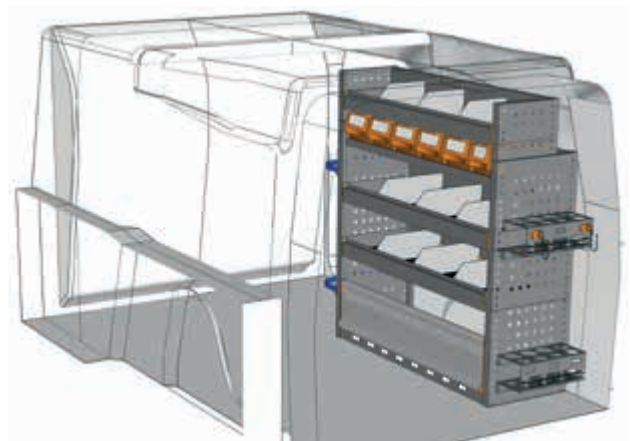

VOORBEELD - EXAMPLE

PA 1011 04*

B=1016 T=365 H=1100 mm - W=1016 D=365 H=1100 mm

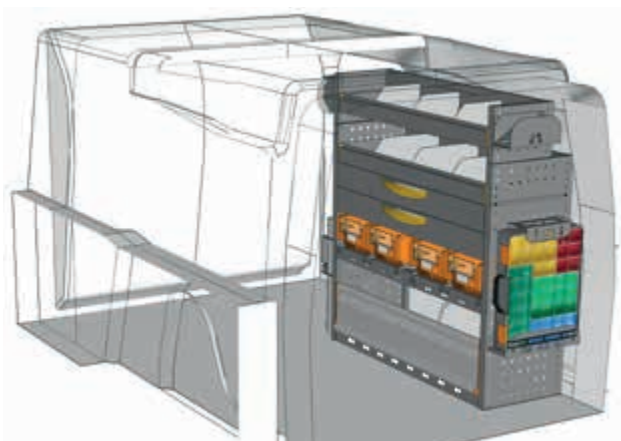
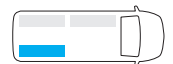

VOORBEELD - EXAMPLE

PA 1011 05*

B=1016 T=365 H=1100 mm - W=1016 D=365 H=1100 mm



Heeft u uw ideale inrichting niet gevonden?
Voor bedrijfswageninrichtingen op maat neemt u contact op met onze vakmensen.
Op de achterzijde vindt u de adresgegevens of bezoek onze website www.storevannederland.nl

Didn't find the equipment you're looking for?
Leave it to our experts.
See the back of this catalogue and contact the nearest StoreVan point or visit our website.



* Inclusief bevestigingsmateriaal - Fixing kit included

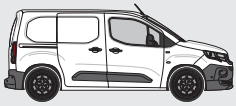

**Perfekte integratie tussen
bedrijfswagen en mobiele
werkplaats**

Perfect integration between
vehicle and mobile workshop
equipment



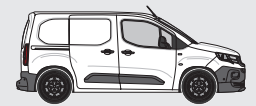

De professionele StoreVan bedrijfswageninrichting wordt perfect geïntegreerd in uw voertuig.
Vervaardigd uit doos- en kokerprofielen van verzinkt staal, voorzien van een dompelbad verfsysteem, net als uw bedrijfswagen. Sterk als staal en licht als aluminium.
Geïntegreerde bevestigingssysteem zorgen ervoor, dat volgens de nieuwste richtlijnen en wetgeving ladingen kunnen worden vervoerd.

The Store Van **PROFESSIONAL equipment solution** is perfectly integrated in your vehicle and has been designed to enhance its structural and dynamic characteristics. The modules of this new **equipment for commercial vehicles**, such as shelving units for vans, are factory fitted with elements ensuring a perfect load anchoring to the chassis of your vehicle with "Airline" anchoring systems.
Both vertical and horizontal load restraining elements can be installed in your van thanks to the new SAFETY FLOOR panel.



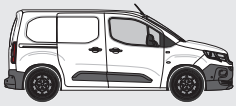

L1 H1

CITROËN BERLINGO
BEDRIJFSWAGEN - PANEL VAN

PROFESSIONAL

INRICHTINGSVOORBEELDEN - FITTINGS EXAMPLES

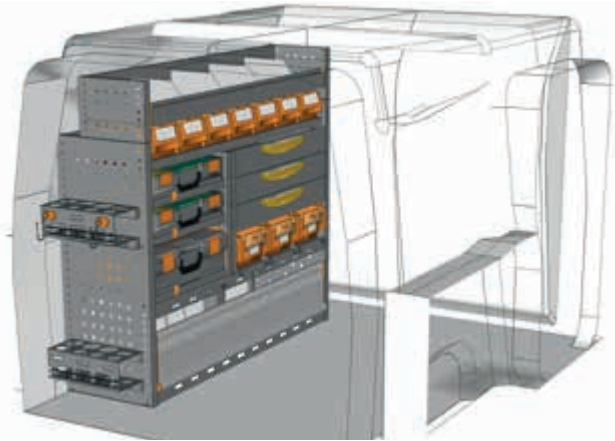

VOORBEELD - EXAMPLE

PA 1211 P1*

B=1225 T=365 H=1100 mm - W=1225 D=365 H=1100 mm

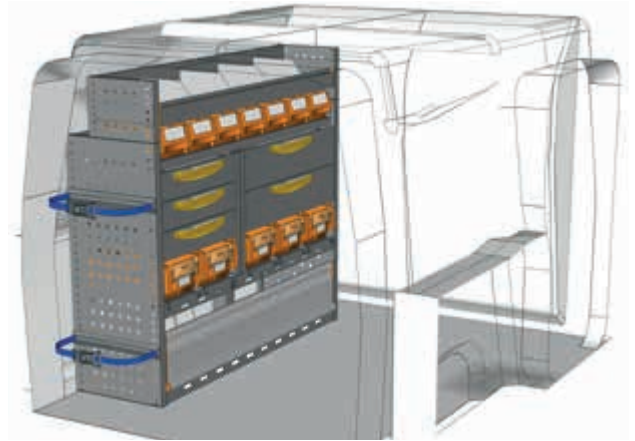
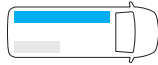

VOORBEELD - EXAMPLE

PA 1211 P2*

B=1225 T=365 H=1100 mm - W=1225 D=365 H=1100 mm

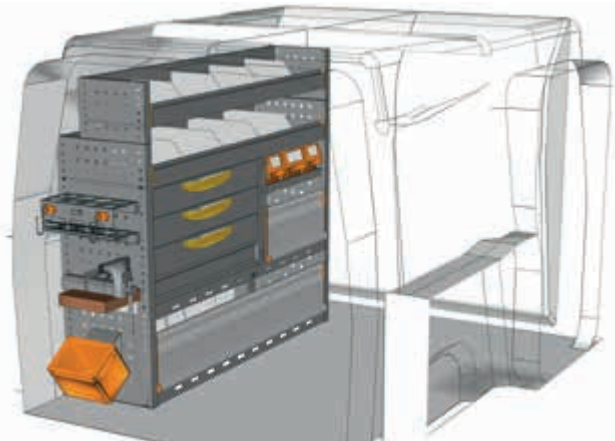
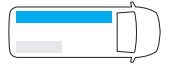

VOORBEELD - EXAMPLE

PA 1211 P3*

B=1225 T=365 H=1100 mm - W=1225 D=365 H=1100 mm

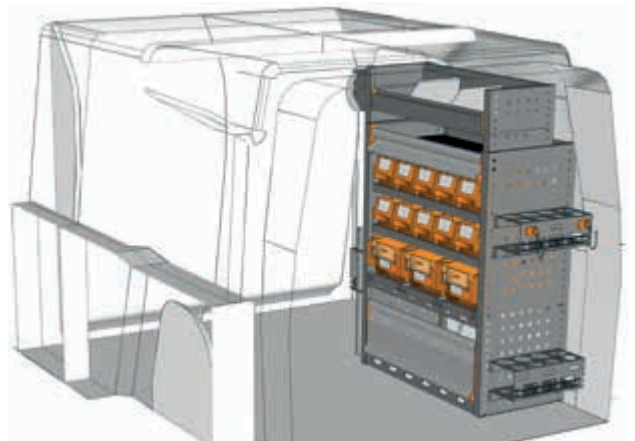
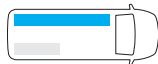

VOORBEELD - EXAMPLE

PA 0711 P1*

B=717 T=365 H=1100 mm - W=717 D=365 H=1100 mm

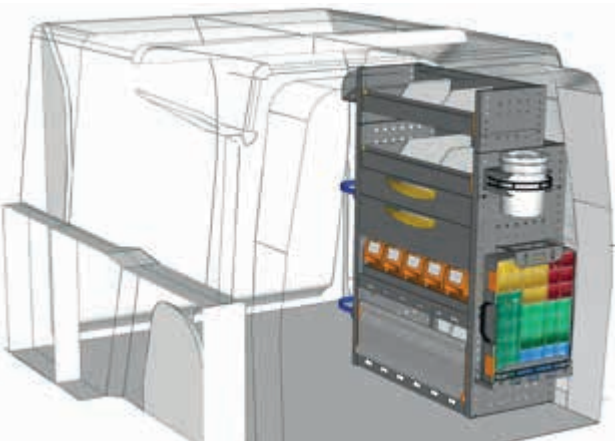

VOORBEELD - EXAMPLE

PA 0711 P2*

B=717 T=365 H=1100 mm - W=717 D=365 H=1100 mm

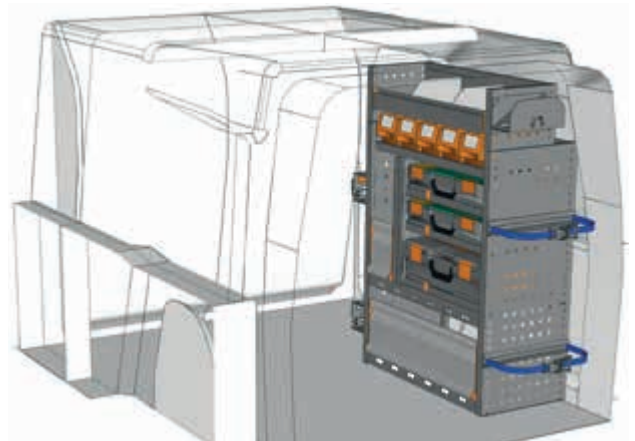
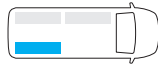

VOORBEELD - EXAMPLE

PA 0711 P3*

B=717 T=365 H=1100 mm - W=717 D=365 H=1100 mm



* Inclusief bevestigingsmateriaal - Fixing kit included

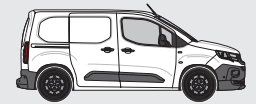

INRICHTINGSVOORBEELDEN - FITTINGS EXAMPLES

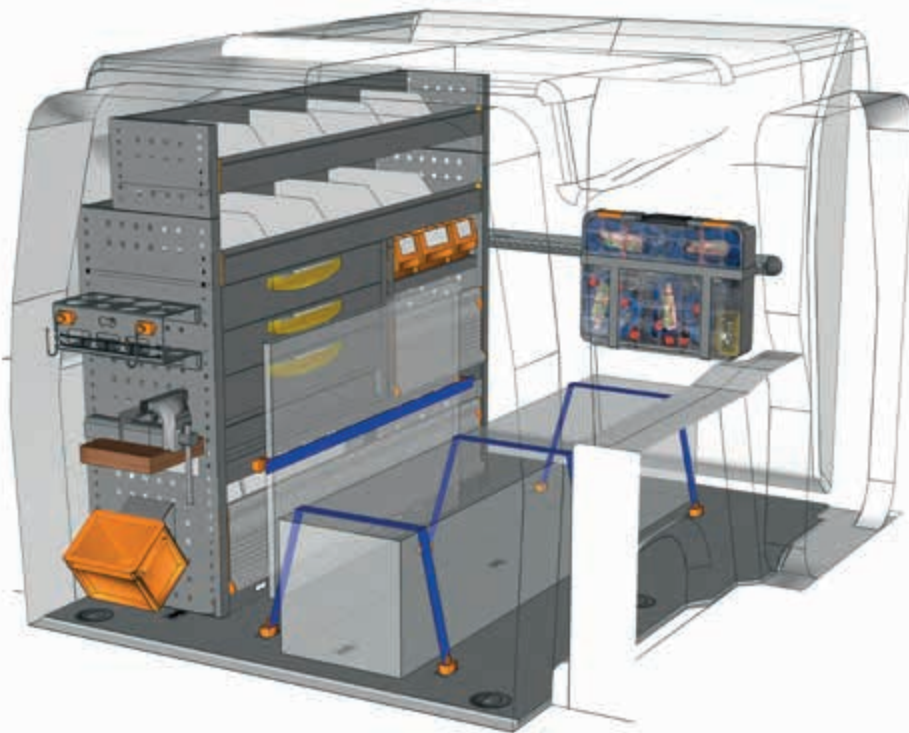

VOORBEELD - EXAMPLE

EXAMPLE PA L1H1 P1*



- | | |
|----------------|-------------|
| 1 x PA 1211 P3 | 2 x V22124 |
| 1 x PA 10K1 B1 | 2 x V22148 |
| 1 x V22585 | 1 x YELLOW |
| 1 x V18029 10 | 4 x V225820 |
| 2 x V22106 | |
| 1 x BOX080 | |
| 1 x CPV080 | |
| 2 x V22136 | |

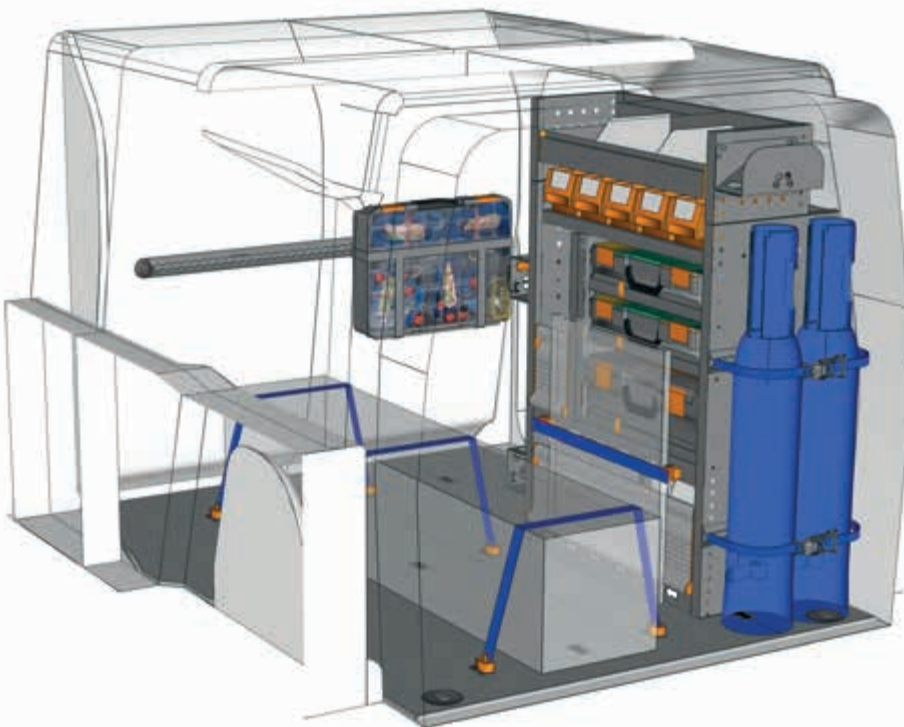

VOORBEELD - EXAMPLE

EXAMPLE PA L1H1 P2*



- | | |
|----------------|-------------|
| 1 x PA 0711 P3 | 2 x V22124 |
| 1 x PA 10K1 B1 | 2 x V22148 |
| 1 x V22585 | 1 x YELLOW |
| 1 x V18029 10 | 4 x V225820 |
| 2 x V22106 | |
| 1 x BOX080 | |
| 1 x CPV080 | |
| 2 x V22136 | |

Heeft u uw ideale inrichting niet gevonden?
Voor bedrijfswageninrichtingen op maat neemt u contact op met onze vakmensen.
Op de achterzijde vindt u de adresgegevens of bezoek onze website www.storevannederland.nl

Didn't find the equipment you're looking for?
Leave it to our experts.
See the back of this catalogue and contact the nearest StoreVan point or visit our website.

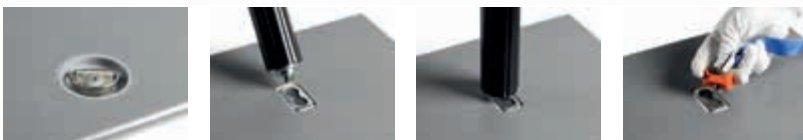

Zie pagina's 10/11
see pages 10/11

* Inclusief bevestigingsmateriaal - Fixing kit included

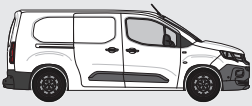

L2 H1

CITROËN BERLINGO
BEDRIJFSWAGEN - PANEL VAN

PROFESSIONAL

INRICHTINGSVOORBEELDEN - FITTINGS EXAMPLES

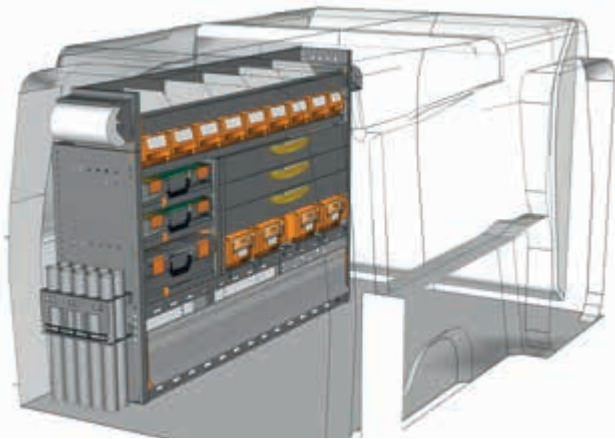

VOORBEELD - EXAMPLE

PA 1511 P1*

B=1524 T=365 H=1100 mm - W=1524 D=365 H=1100 mm

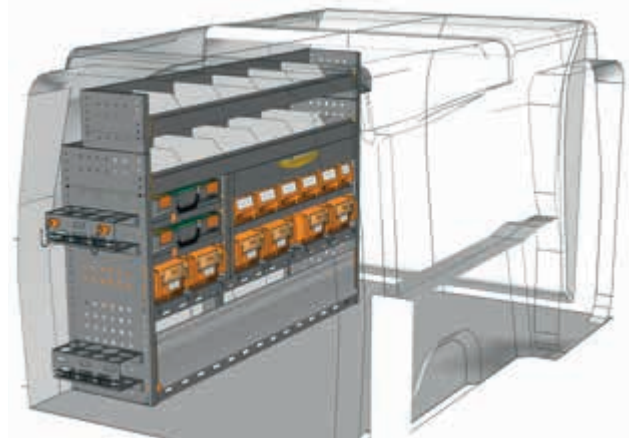
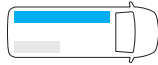

VOORBEELD - EXAMPLE

PA 1511 P2*

B=1524 T=365 H=1100 mm - W=1524 D=365 H=1100 mm

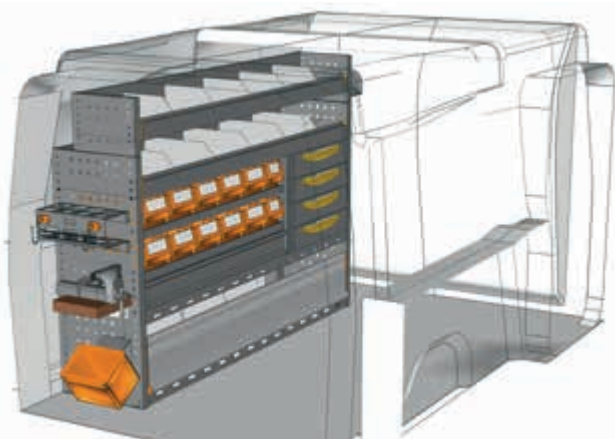
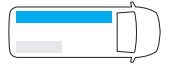

VOORBEELD - EXAMPLE

PA 1511 P3*

B=1524 T=365 H=1100 mm - W=1524 D=365 H=1100 mm

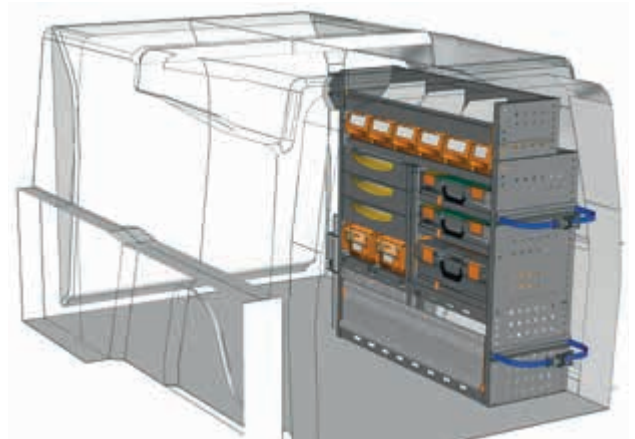
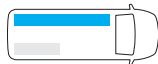

VOORBEELD - EXAMPLE

PA 1011 P1*

B=1016 T=365 H=1100 mm - W=1016 D=365 H=1100 mm

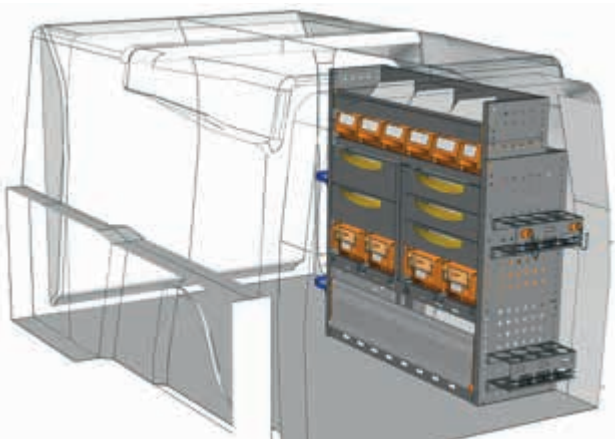

VOORBEELD - EXAMPLE

PA 1011 P2*

B=1016 T=365 H=1100 mm - W=1016 D=365 H=1100 mm

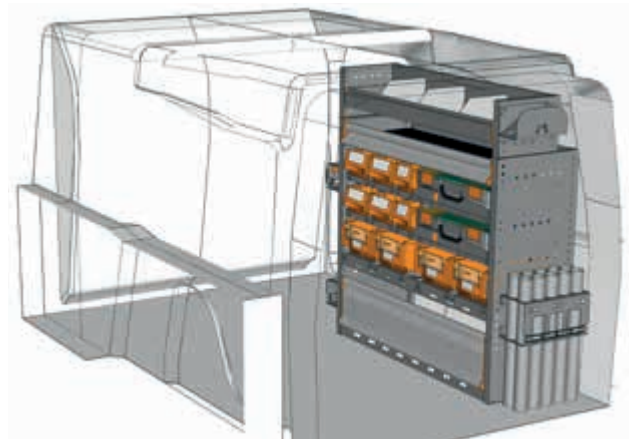
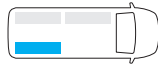

VOORBEELD - EXAMPLE

PA 1011 P3*

B=1016 T=365 H=1100 mm - W=1016 D=365 H=1100 mm



* Inclusief bevestigingsmateriaal - Fixing kit included

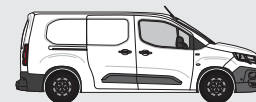

INRICHTINGSVOORBEELDEN - FITTINGS EXAMPLES

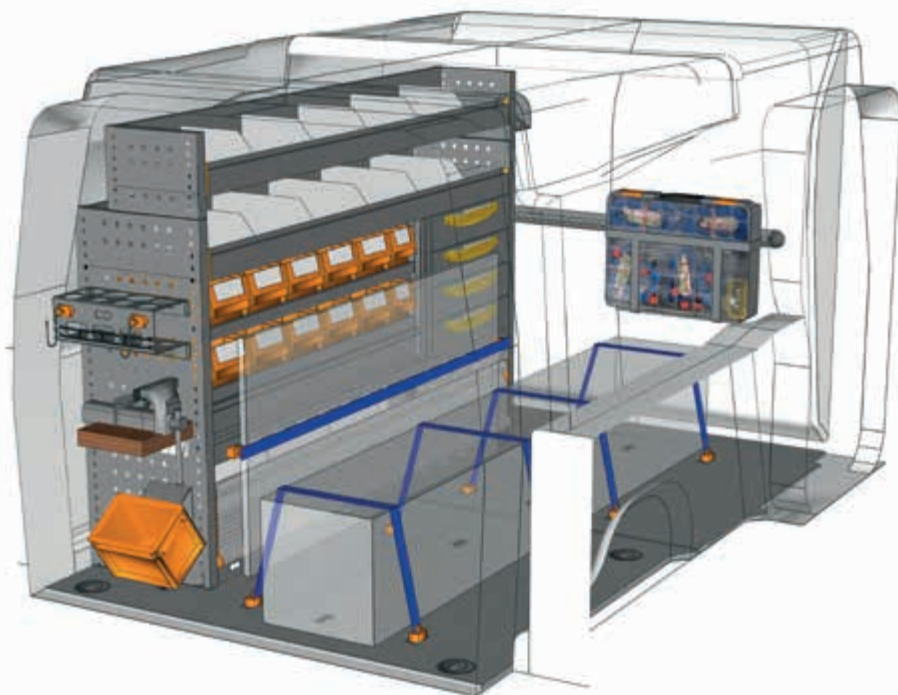

VOORBEELD - EXAMPLE

EXAMPLE PA L2H1 P1*



- | | |
|----------------|-------------|
| 1 x PA 1511 P3 | 2 x V22124 |
| 1 x PA 20K1 B1 | 2 x V22148 |
| 1 x V22585 | 1 x YELLOW |
| 1 x V18029 10 | 4 x V225820 |
| 2 x V22106 | |
| 1 x BOX080 | |
| 1 x CPV080 | |
| 2 x V22136 | |

BEDRIJFSWAGEN - PANEL VAN
CITROËN BERLINGO
PROFESSIONAL

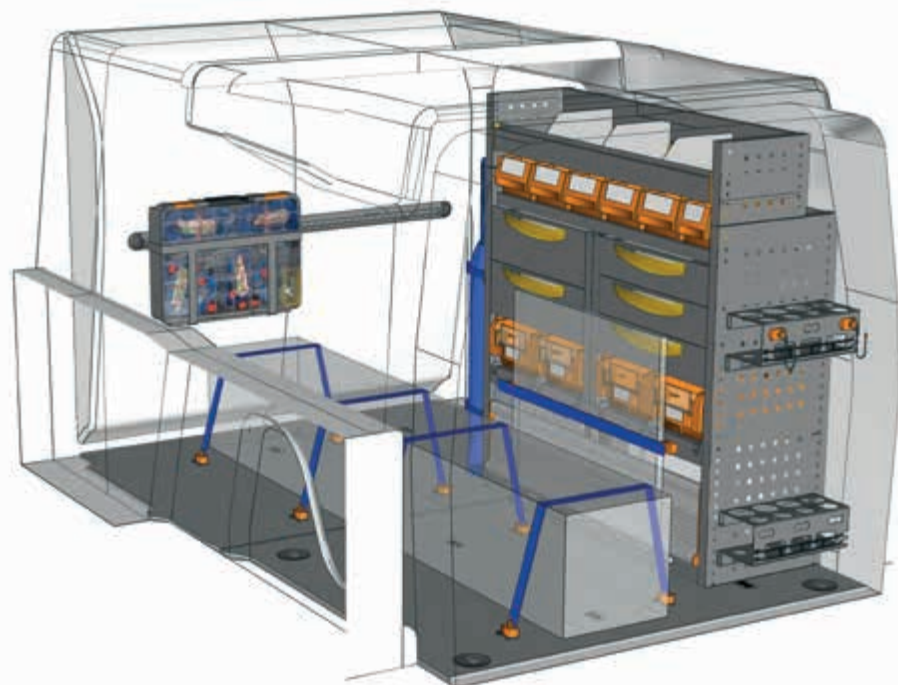

VOORBEELD - EXAMPLE

EXAMPLE PA L2H1 P2*



- | | |
|----------------|-------------|
| 1 x PA 1011 P2 | 2 x V22124 |
| 1 x PA 20K1 B1 | 2 x V22148 |
| 1 x V22585 | 1 x YELLOW |
| 1 x V18029 10 | 4 x V225820 |
| 2 x V22106 | |
| 1 x BOX080 | |
| 1 x CPV080 | |
| 2 x V22136 | |

Heeft u uw ideale inrichting niet gevonden?
Voor bedrijfswageninrichtingen op maat neemt u contact op met onze vakmensen.
Op de achterzijde vindt u de adresgegevens of bezoek onze website www.storevannederland.nl

Didn't find the equipment you're looking for?
Leave it to our experts.
See the back of this catalogue and contact the nearest StoreVan point or visit our website.

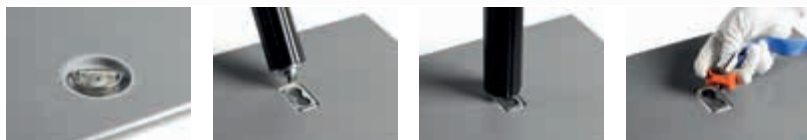

Zie pagina's 10/11
see pages 10/11

* Inclusief bevestigingsmateriaal - Fixing kit included

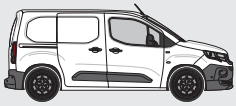

Voertuigen en mobiliteit

All-out mobility

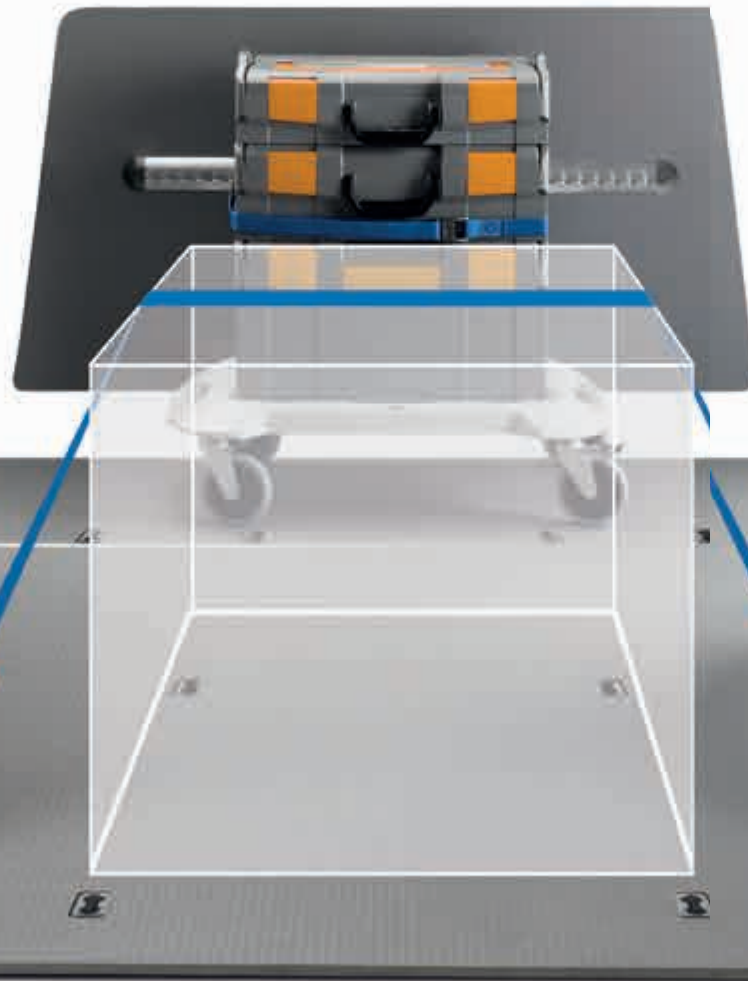

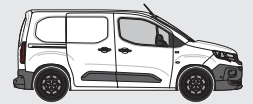

De **mobiele bedrijfswagenuitrustingen** van StoreVan helpen de gebruiker de goederen en gereedschappen gemakkelijk en snel van de bedrijfswagen naar de werkplek te vervoeren. De StoreBoxen 102/136/238 zijn hiervoor een goed voorbeeld. In de module fungeren zij als opbergplaats, maar de koffers kunnen natuurlijk ook uit de module worden gehaald. Op die manier heeft de gebruiker gereedschappen en onderdelen altijd bij de hand. De nieuwe bevestigingsprofielen verbeteren de functionaliteit van de modules zonder gewichtstoename. Zowel verticale als horizontale lading-zekering accessoires kunnen door de SAFETY FLOOR en bevestigingsprofielen worden toegepast.

The **MOBILE equipment solution** integrates Store Van fittings for commercial vehicles with small-parts cases, series STORE BOX 102 – 136 – 238, and trolleys by which **mobile workshop** users can easily carry their goods and tools from their van to the workplace.

The new "Airline" anchoring fittings improve the stability of modules with no weight increase. Here shelving units are integrated with elements where "Airline" anchoring systems can easily fit. Both vertical and horizontal load restraining elements can be installed in your van thanks to the new SAFETY FLOOR flooring panels.



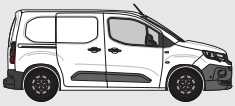

L1 H1

INRICHTINGSVOORBEELDEN - FITTINGS EXAMPLES

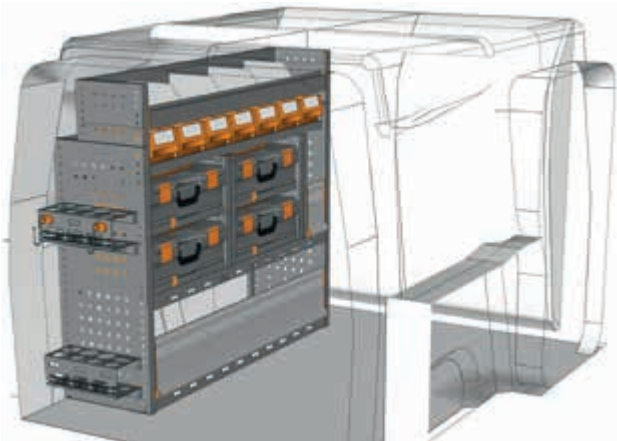

VOORBEELD - EXAMPLE

PA 1211 M1*

B=1225 T=365 H=1100 mm - W=1225 D=365 H=1100 mm

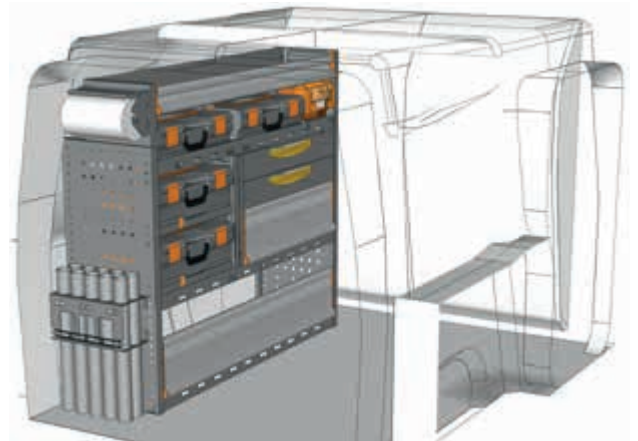
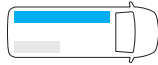

VOORBEELD - EXAMPLE

PA 1211 M2*

B=1225 T=365 H=1100 mm - W=1225 D=365 H=1100 mm

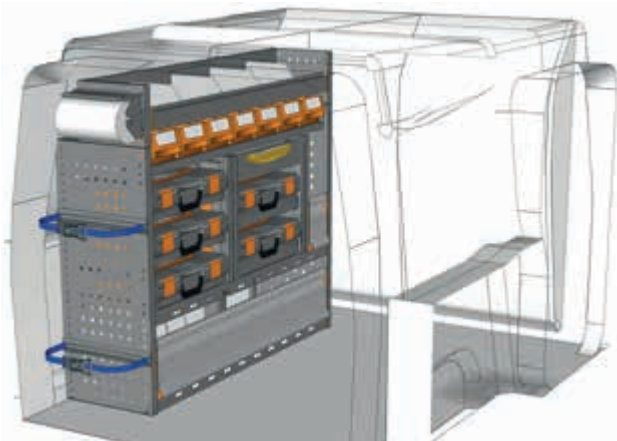
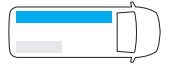

VOORBEELD - EXAMPLE

PA 1211 M3*

B=1225 T=365 H=1100 mm - W=1225 D=365 H=1100 mm

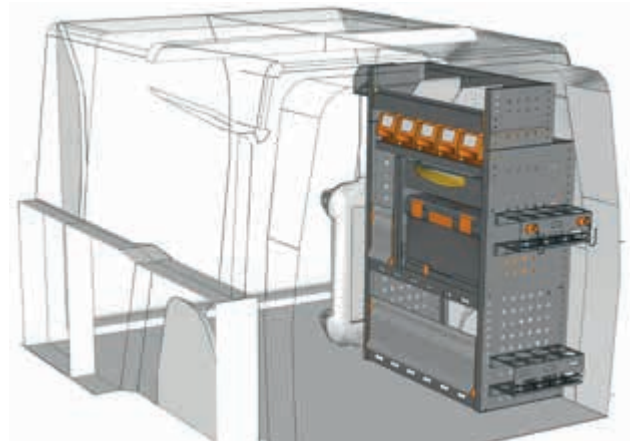
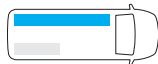

VOORBEELD - EXAMPLE

PA 0711 M1*

B=717 T=365 H=1100 mm - W=717 D=365 H=1100 mm

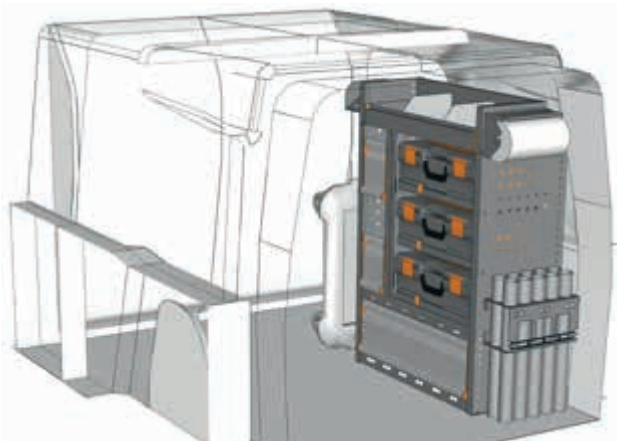

VOORBEELD - EXAMPLE

PA 0711 M2*

B=717 T=365 H=1050 mm - W=717 D=365 H=1050 mm

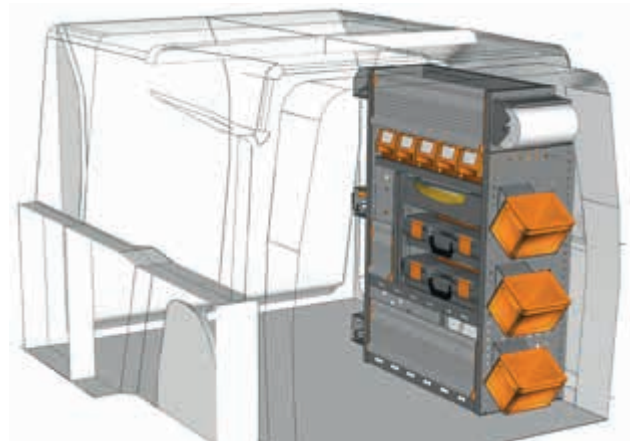
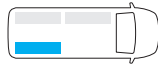

VOORBEELD - EXAMPLE

PA 0711 M3*

B=717 T=365 H=1100 mm - W=717 D=365 H=1100 mm



* Inclusief bevestigingsmateriaal - Fixing kit included

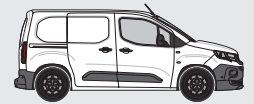

INRICHTINGSVOORBEELDEN - FITTINGS EXAMPLES

BEDRIJFSWAGEN - PANEL VAN
CITROËN BERLINGO

MOBILE

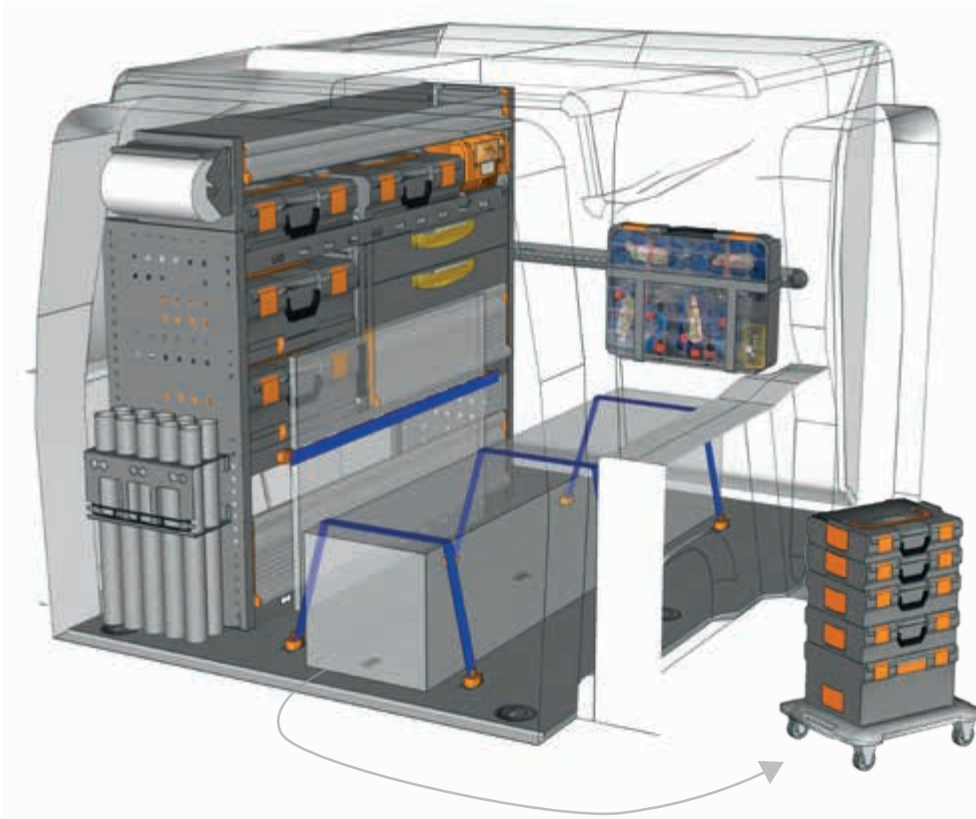

VOORBEELD - EXAMPLE

EXAMPLE PA L1H1 M1*



- | | |
|----------------|-------------|
| 1 x PA 1211 M2 | 2 x V22124 |
| 1 x PA 10K1 B1 | 2 x V22148 |
| 1 x V22585 | 1 x YELLOW |
| 1 x V18029 10 | 4 x V225820 |
| 2 x V22106 | |
| 1 x BOX080 | |
| 1 x CPV080 | |
| 2 x V22136 | |

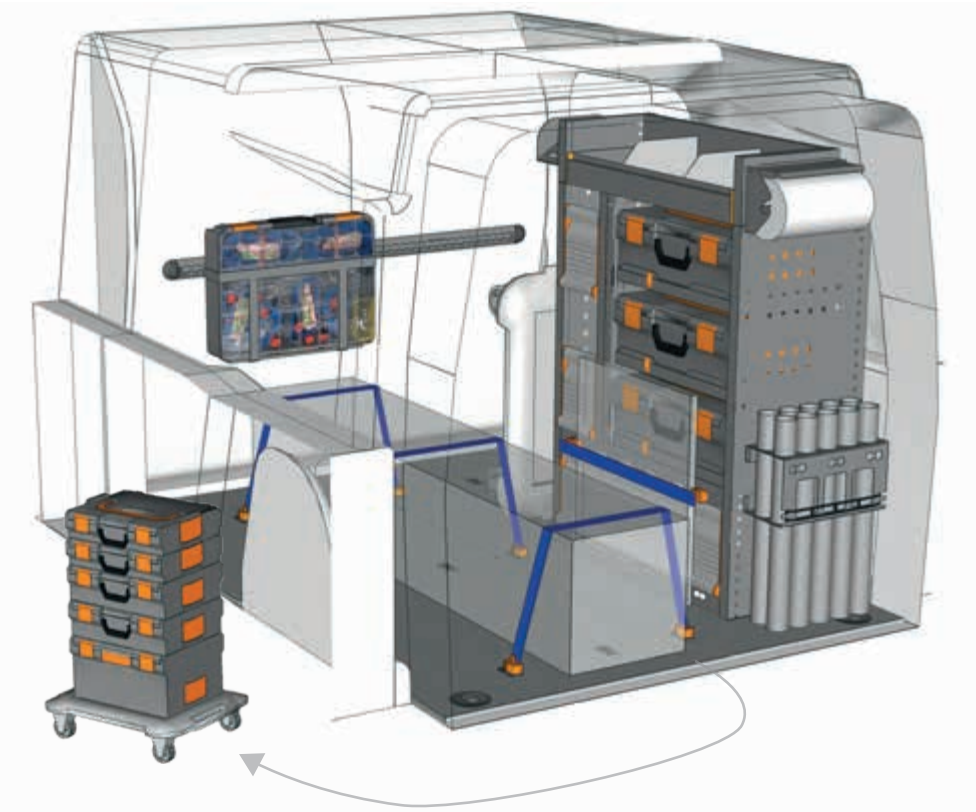

VOORBEELD - EXAMPLE

EXAMPLE PA L1H1 M2*



- | | |
|----------------|-------------|
| 1 x PA 0711 M2 | 2 x V22124 |
| 1 x PA 10K1 B1 | 2 x V22148 |
| 1 x V22585 | 1 x YELLOW |
| 1 x V18029 10 | 4 x V225820 |
| 2 x V22106 | |
| 1 x BOX080 | |
| 1 x CPV080 | |
| 2 x V22136 | |

Heeft u uw ideale inrichting niet gevonden?
Voor bedrijfswageninrichtingen op maat neemt u contact op met onze vakmensen.
Op de achterzijde vindt u de adresgegevens of bezoek onze website www.storevannederland.nl

Didn't find the equipment you're looking for?
Leave it to our experts.
See the back of this catalogue and contact the nearest StoreVan point or visit our website.

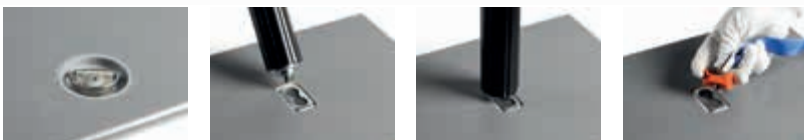

Zie pagina's 10/11
see pages 10/11

* Inclusief bevestigingsmateriaal - Fixing kit included

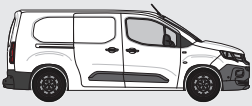

L2 H1

CITROËN BERLINGO
BEDRIJFSWAGEN - PANEL VAN

MOBILE

INRICHTINGSVOORBEELDEN - FITTINGS EXAMPLES

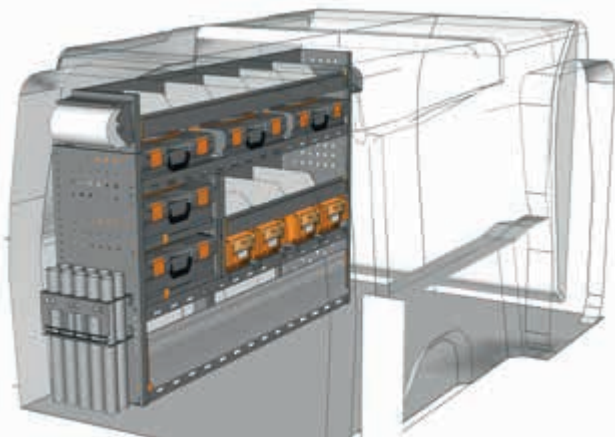

VOORBEELD - EXAMPLE

PA 1511 M1*

B=1524 T=365 H=1100 mm - W=1524 D=365 H=1100 mm

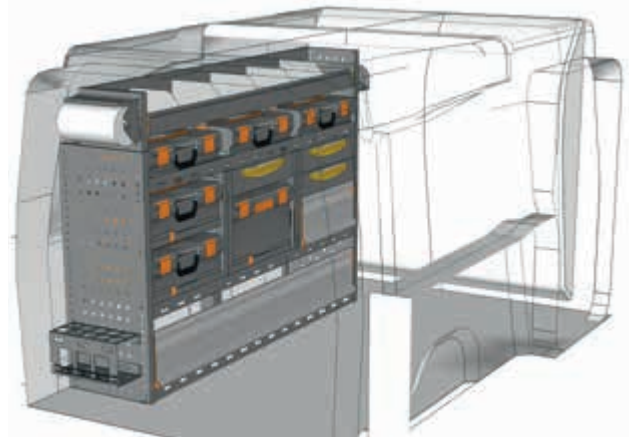
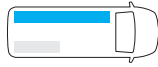

VOORBEELD - EXAMPLE

PA 1511 M2*

B=1524 T=365 H=1100 mm - W=1524 D=365 H=1100 mm

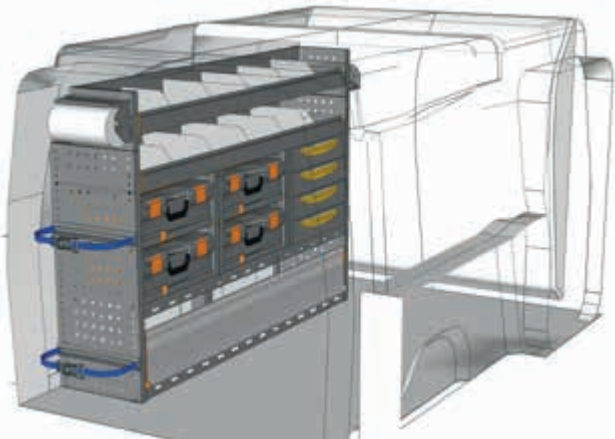

VOORBEELD - EXAMPLE

PA 1511 M3*

B=1524 T=365 H=1100 mm - W=1524 D=365 H=1100 mm

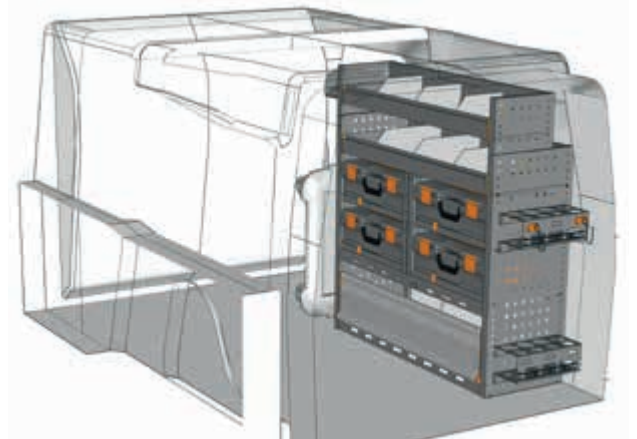
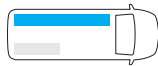

VOORBEELD - EXAMPLE

PA 1011 M1*

B=1016 T=365 H=1100 mm - W=1016 D=365 H=1100 mm

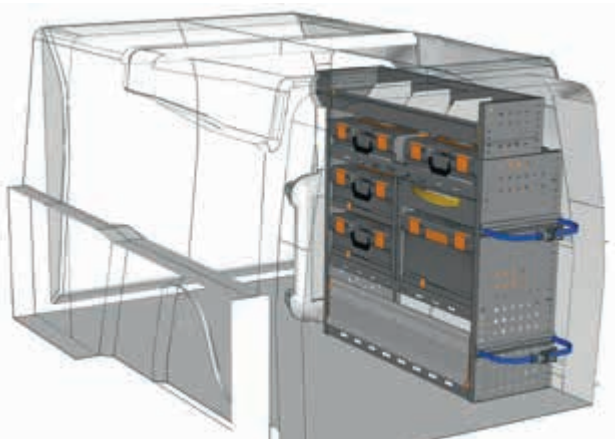

VOORBEELD - EXAMPLE

PA 1011 M2*

B=1016 T=365 H=1100 mm - W=1016 D=365 H=1100 mm

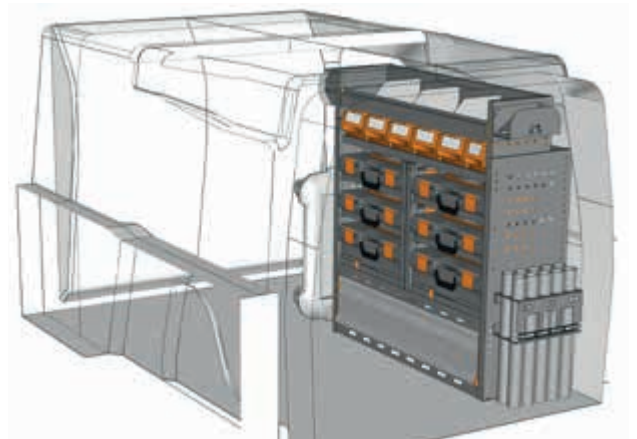
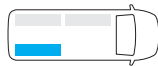

VOORBEELD - EXAMPLE

PA 1011 M3*

B=1016 T=365 H=1100 mm - W=1016 D=365 H=1100 mm



* Inclusief bevestigingsmateriaal - Fixing kit included

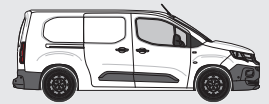

INRICHTINGSVOORBEELDEN - FITTINGS EXAMPLES

BEDRIJFSWAGEN - PANEL VAN
CITROËN BERLINGO

MOBILE

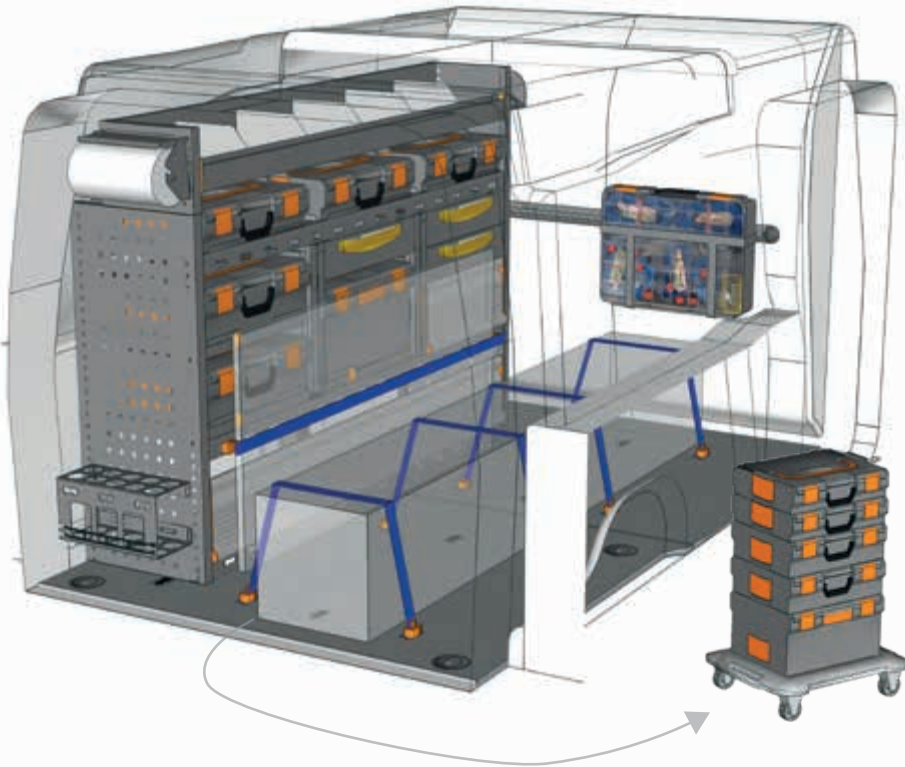

VOORBEELD - EXAMPLE

EXAMPLE PA L2H1 M1*



- | | |
|----------------|-------------|
| 1 x PA 1511 M2 | 2 x V22124 |
| 1 x PA 20K1 B1 | 2 x V22148 |
| 1 x V22585 | 1 x YELLOW |
| 1 x V18029 10 | 4 x V225820 |
| 2 x V22106 | |
| 1 x BOX080 | |
| 1 x CPV080 | |
| 2 x V22136 | |

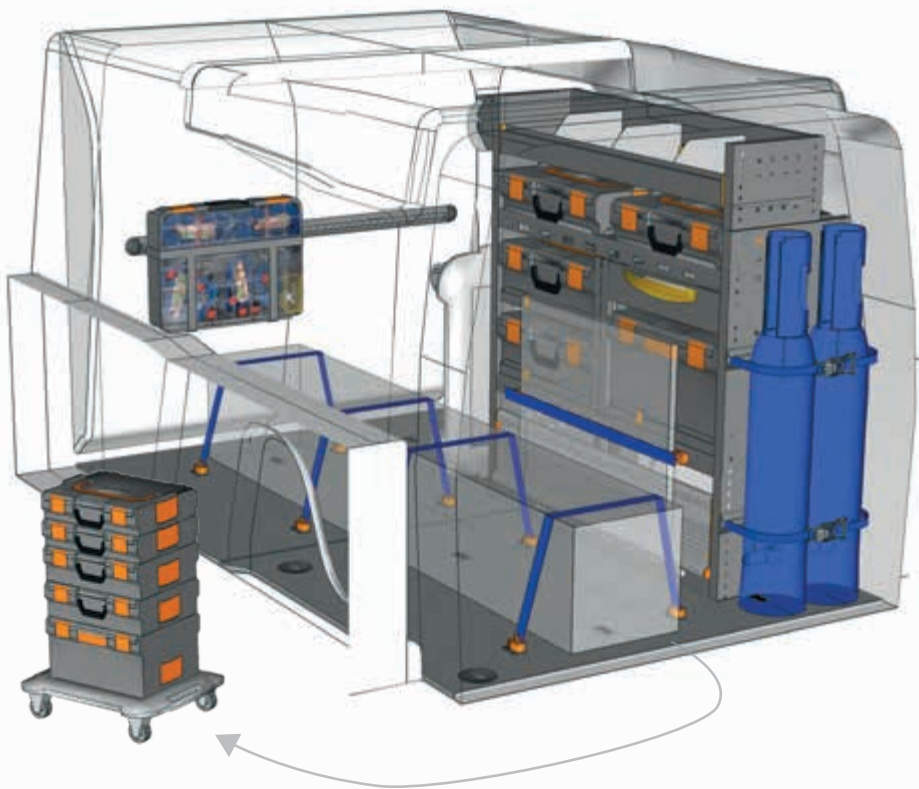

VOORBEELD - EXAMPLE

EXAMPLE PA L2H1 M2*



- | | |
|----------------|-------------|
| 1 x PA 1011 M2 | 2 x V22124 |
| 1 x PA 20K1 B1 | 2 x V22148 |
| 1 x V22585 | 1 x YELLOW |
| 1 x V18029 10 | 4 x V225820 |
| 2 x V22106 | |
| 1 x BOX080 | |
| 1 x CPV080 | |
| 2 x V22136 | |

Heeft u uw ideale inrichting niet gevonden?
Voor bedrijfswageninrichtingen op maat neemt u contact op met onze vakmensen.
Op de achterzijde vindt u de adresgegevens of bezoek onze website www.storevannederland.nl

Didn't find the equipment you're looking for?
Leave it to our experts.
See the back of this catalogue and contact the nearest StoreVan point or visit our website.



Zie pagina's 10/11
see pages 10/11

* Inclusief bevestigingsmateriaal - Fixing kit included

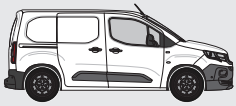

**Ergonomische uitrusting die het werk
eenvoudiger en veiliger maakt**

**Ergonomic equipment that makes work
easier and safer**

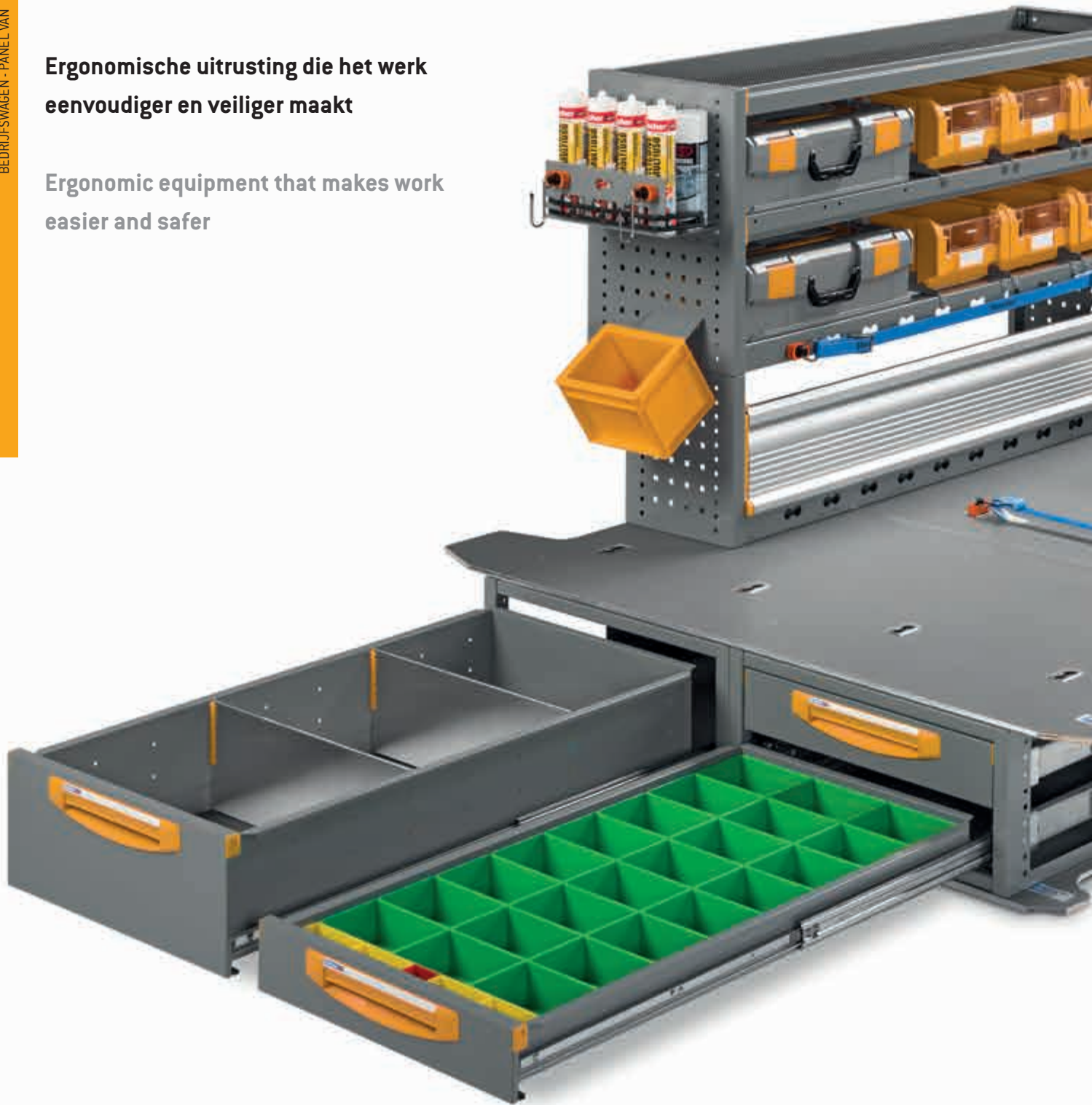

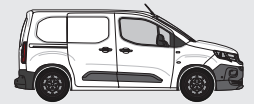

FLOOR UP is een handig systeem om de ruimte in uw bedrijfswagen optimaal te benutten. Dit betreft een veilige constructie met gedeelde vloer. Door dit inventieve systeem van StoreVan **wordt de laadcapaciteit van kleine bedrijfswagens verbeterd.**

De lades zijn 100% uittrekbaar door telescoopgeleiders en hebben een draagvermogen van **80 kg**. Montage gebeurt via een subframe, waardoor gaten in de carrosserie niet nodig zijn. FLOOR UP is leverbaar in diverse afmetingen en mogelijkheden. Daarnaast heeft u een

ruime keuze uit indelings-accessoires, zoals aluminium dividers en polypropyleen boxen. FLOOR UP is sterk als staal en licht als aluminium en neemt graag het zware werk uit uw handen!

- TÜV gecertificeerd
- **12 extra AIRLINE ankerpunten met 200 daN**
- Voldoet aan de EU-richtlijn 2014/47 / EU met betrekking tot veiligheid en ladingzekering

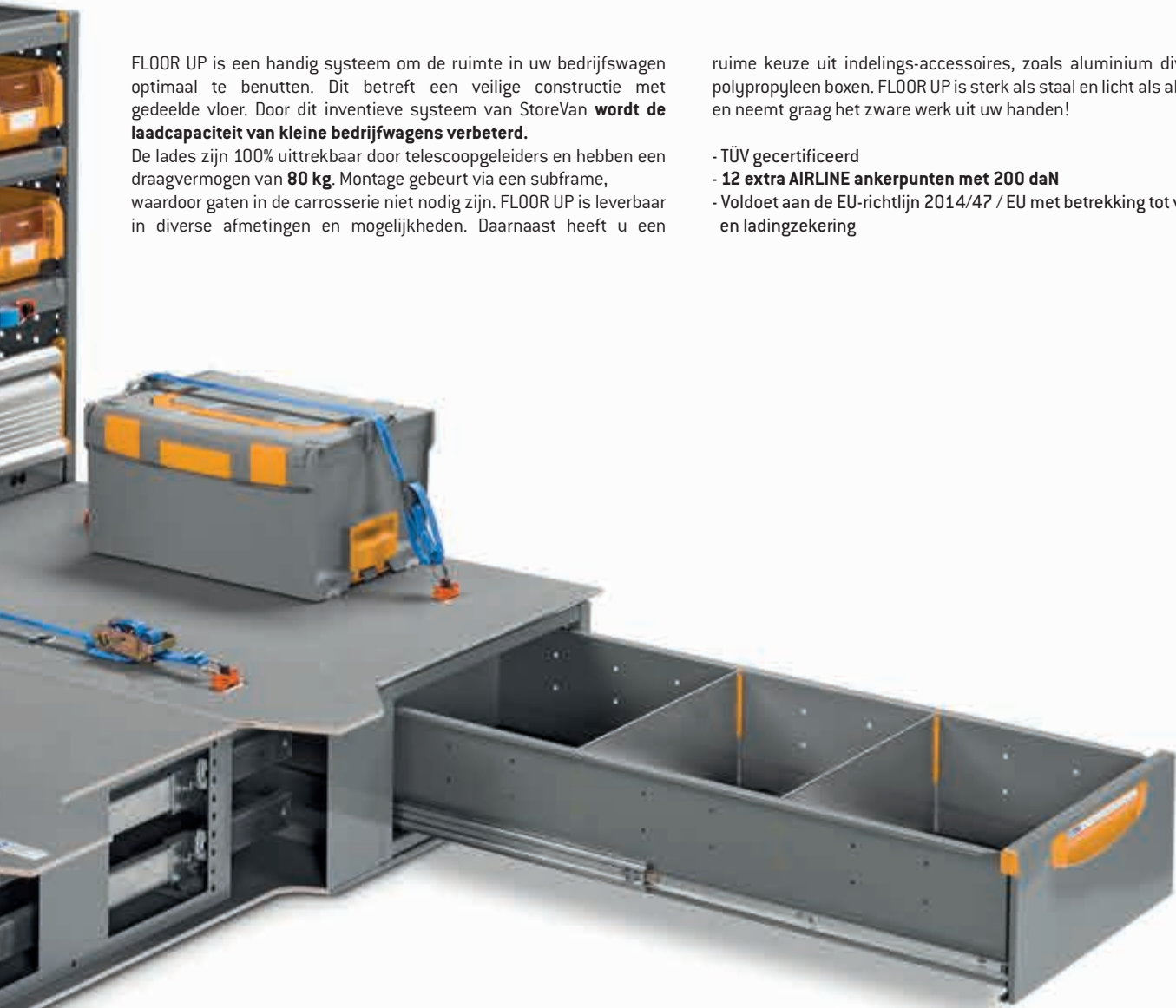

FLOOR UP is the double level outfitting system for vans with under-floor drawers developed by Store Van to **improve the load capacity of light-duty vehicles with cargo volumes below 5 m³**. Goods storage and handling have been designed to improve ergonomics and make transport easy and fast - with special focus on the use, and the resulting need for safe transport, of tools, power tools and equipment in general. This result has been achieved thanks to the introduction of extra long under-floor drawers with a large internal volume, placed at the rear end and along the sides of vehicles next to the doors. The full-height side walls of the drawers prevent the contents from spilling out during transport.

The under-floor drawers combine high capacity, **80 kg per drawer**, with

a wide range of separation items, such as movable aluminium dividers and plastic boxes of various sizes to divide, contain and secure any contained material.

In the upper part of the outfitting a 9-layer marine birch wood floor has been added, with special high-strength coating with TUV-certified friction coefficient. **12 additional AIRLINE anchor points** with 200 daN pulling strength are supplied as standard, in compliance with the new EU directive 2014/47/EU regarding safety and load securing.

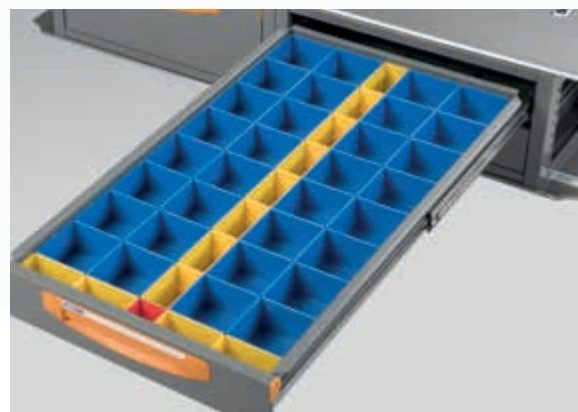

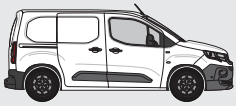

L1 H1

CITROËN BERLINGO
BEDRIJFSWAGEN - PANEL VAN

FLOOR UP 250

INRICHTINGSVOORBEELDEN - FITTINGS EXAMPLES

BODEMPLAAT H 250 mm – FLOORING H 250 mm

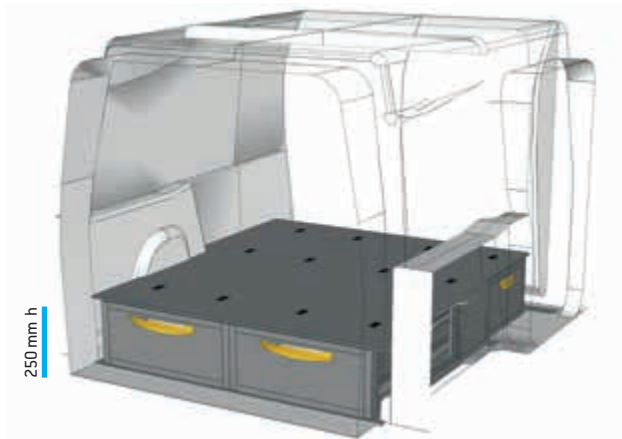

VOORBEELD - EXAMPLE

PA 0250 01*

B=1421 T=1600 H=268 mm - W=1421 D=1600 H=268 mm
(alleen voor plaatstalen schotten / only for sheet steel bulkhead)

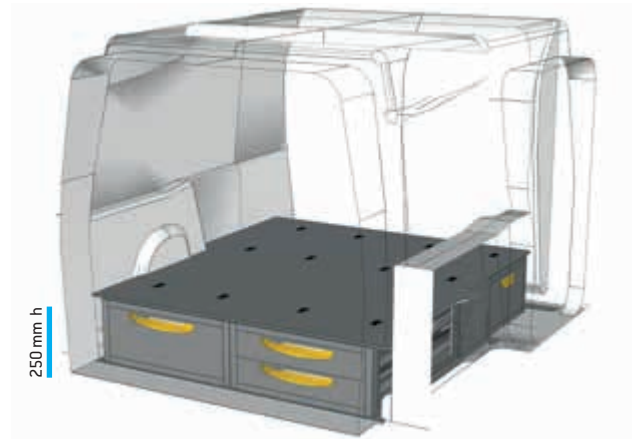

VOORBEELD - EXAMPLE

PA 0250 02*

B=1421 T=1600 H=268 mm - W=1421 D=1600 H=268 mm
(alleen voor plaatstalen schotten / only for sheet steel bulkhead)

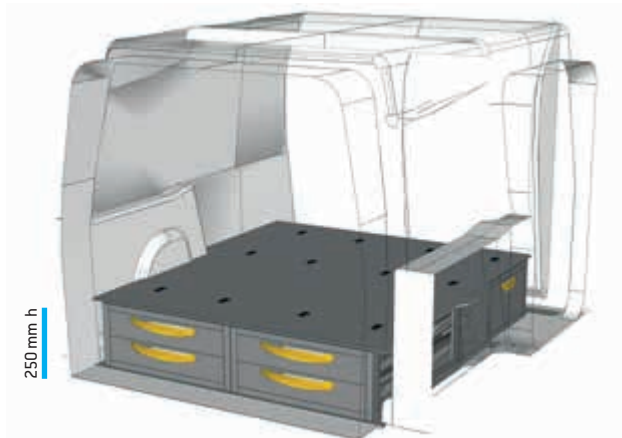

VOORBEELD - EXAMPLE

PA 0250 03*

B=1421 T=1600 H=268 mm - W=1421 D=1600 H=268 mm
(alleen voor plaatstalen schotten / only for sheet steel bulkhead)

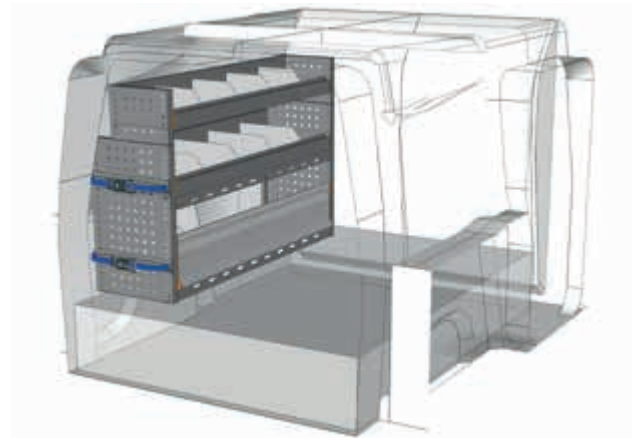

VOORBEELD - EXAMPLE

PA 1208 02*

B=1225 T=365 H=800 mm - W=1225 D=365 H=800 mm

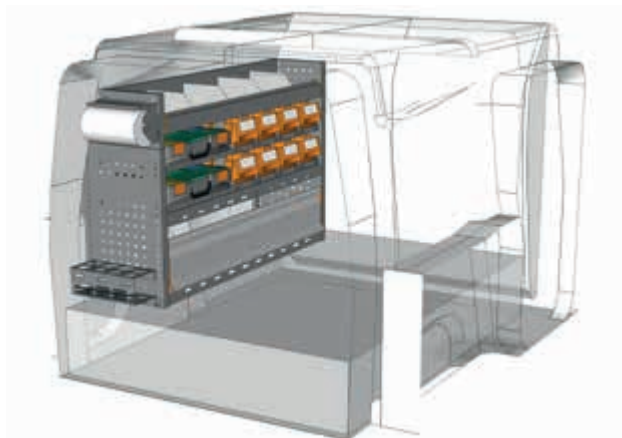
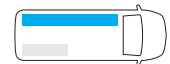

VOORBEELD - EXAMPLE

PA 1208 01*

B=1225 T=365 H=800 mm - W=1225 D=365 H=800 mm

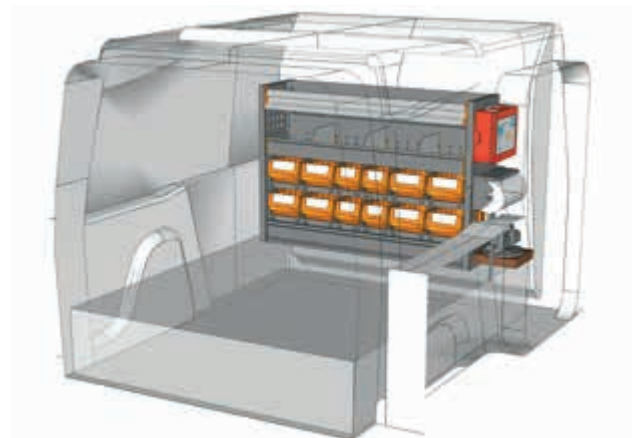
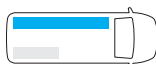

VOORBEELD - EXAMPLE

PA 1007 01*

B=1016 T=265 H=700 mm - W=1016 D=265 H=700 mm



* Inclusief bevestigingsmateriaal - Fixing kit included

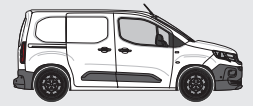

BODEMPLAAT H 250 mm – FLOORING H 250 mm

INRICHTINGSVOORBEELDEN - FITTINGS EXAMPLES

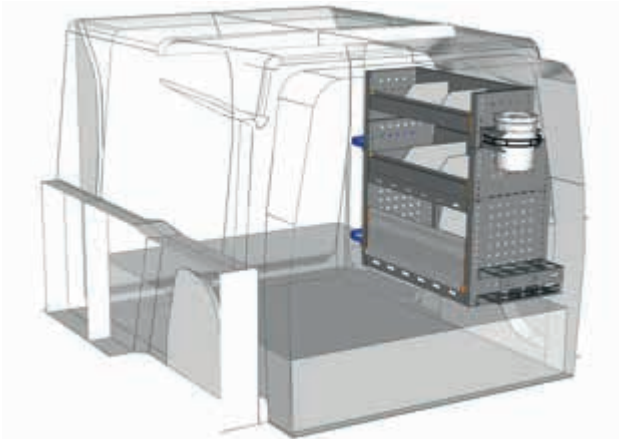

VOORBEELD - EXAMPLE

PA 0708 01*

B=717 T=365 H=800 mm - W=717 D=365 H=800 mm

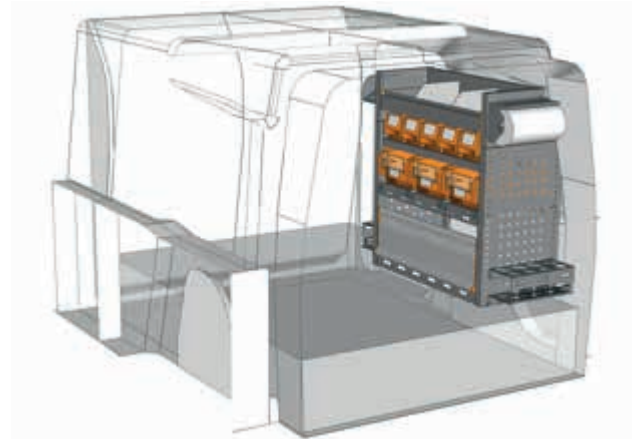
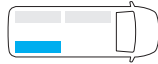

VOORBEELD - EXAMPLE

PA 0708 02*

B=717 T=365 H=800 mm - W=717 D=365 H=800 mm

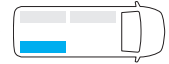

BEDRIJFSWAGEN - PANEL VAN
CITROËN BERLINGO

FLOOR UP 250

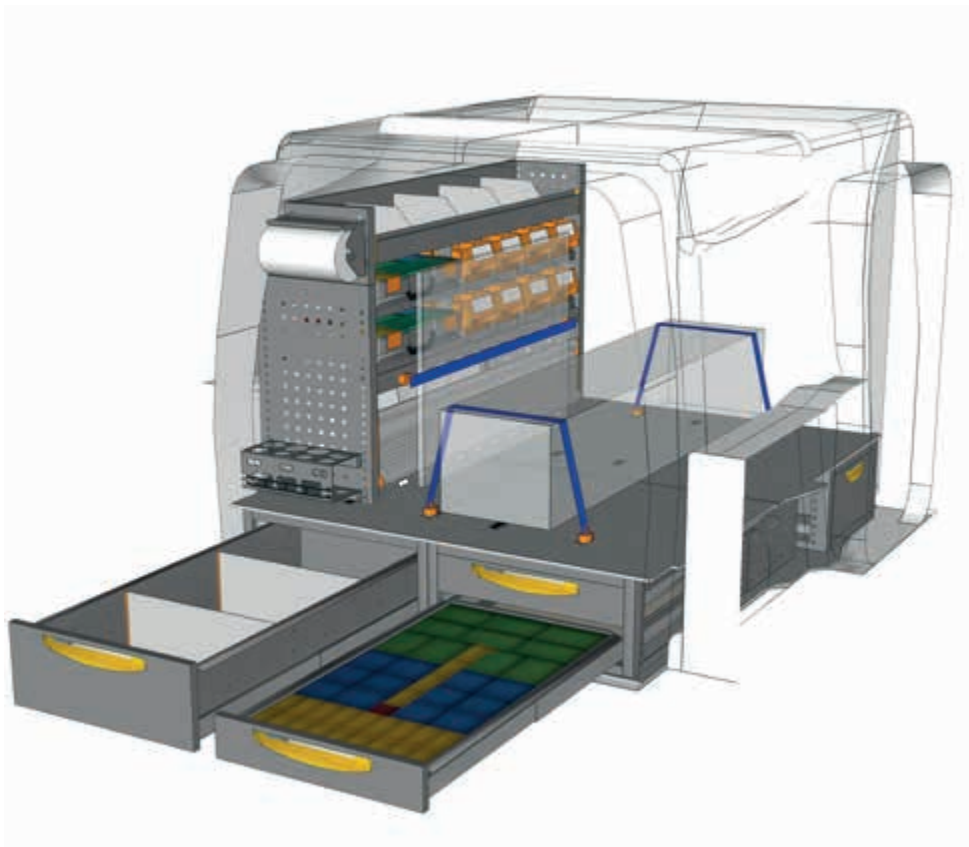

VOORBEELD - EXAMPLE

EXAMPLE PA L1H1 F1*

- 1 x PA 0250 02
- 1 x PA 1208 01
- 1 x E8 108042 B4
- 1 x E8 093058 F0
- 1 x E8 093058 L0
- 1 x E8 108058 B4
- 3 x V22124



Zie pagina's 10/11
see pages 10/11

* Inclusief bevestigingsmateriaal - Fixing kit included

Heeft u uw ideale inrichting niet gevonden?
Voor bedrijfswageninrichtingen op maat neemt u contact op met onze vakmensen.
Op de achterzijde vindt u de adresgegevens of bezoek onze website www.storevannederland.nl

Didn't find the equipment you're looking for?
Leave it to our experts.
See the back of this catalogue and contact the nearest StoreVan point or visit our website.



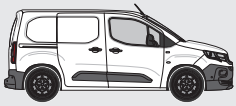

L1 H1

CITROËN BERLINGO
BEDRIJFSWAGEN - PANEL VAN

FLOOR UP 350

INRICHTINGSVOORBEELDEN - FITTINGS EXAMPLES

BODEMPLAAT H 350 mm – FLOORING H 350 mm



VOORBEELD - EXAMPLE

PA 0350 01*

B=1420 T=1576 H=368 mm - W=1420 D=1576 H=368 mm
(alleen voor plaatstalen schotten / only for sheet steel bulkhead)

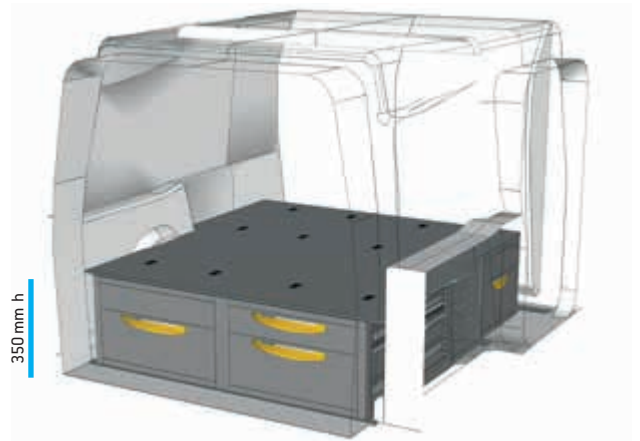

VOORBEELD - EXAMPLE

PA 0350 02*

B=1420 T=1576 H=368 mm - W=1420 D=1576 H=368 mm
(alleen voor plaatstalen schotten / only for sheet steel bulkhead)

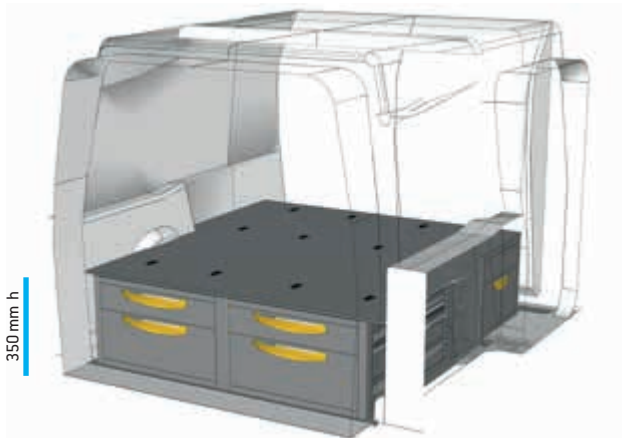

VOORBEELD - EXAMPLE

PA 0350 03*

B=1420 T=1576 H=368 mm - W=1420 D=1576 H=368 mm
(alleen voor plaatstalen schotten / only for sheet steel bulkhead)

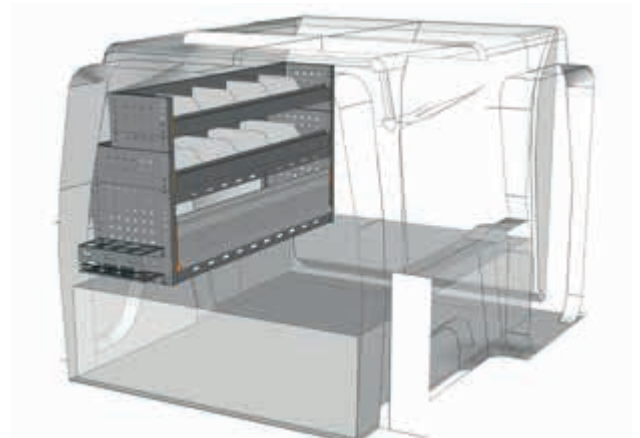

VOORBEELD - EXAMPLE

PA 1207 02*

B=1225 T=365 H=700 mm - W=1225 D=365 H=700 mm

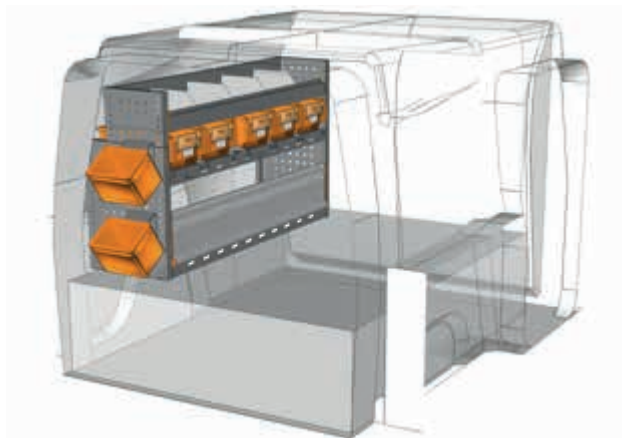
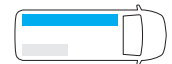

VOORBEELD - EXAMPLE

PA 1207 01*

B=1225 T=365 H=700 mm - W=1225 D=365 H=700 mm

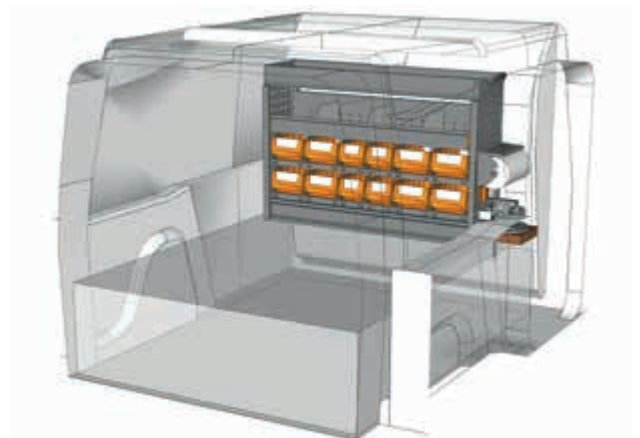

VOORBEELD - EXAMPLE

PA 1007 02*

B=1016 T=265 H=700 mm - W=1016 D=265 H=700 mm



* Inclusief bevestigingsmateriaal - Fixing kit included

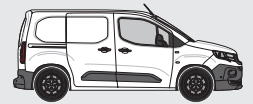

BODEMPLAAT H 350 mm – FLOORING H 350 mm

INRICHTINGSVOORBEELDEN - FITTINGS EXAMPLES

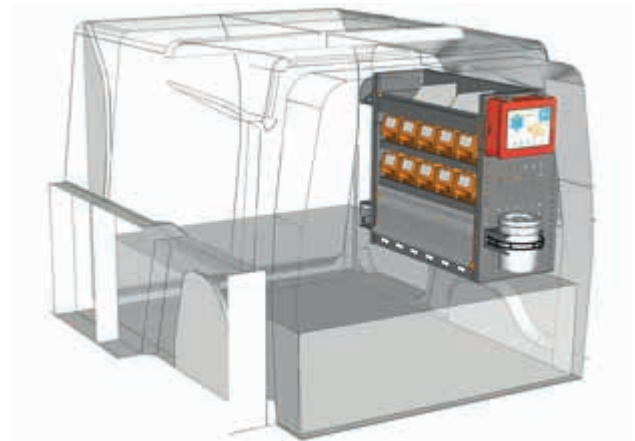
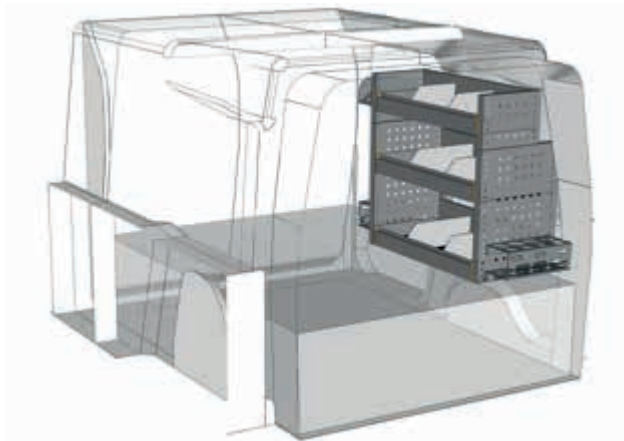

VOORBEELD - EXAMPLE

PA 0707 01*

B=717 T=365 H=700 mm - W=717 D=365 H=700 mm

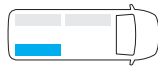

VOORBEELD - EXAMPLE

PA 0707 02*

B=717 T=365 H=700 mm - W=717 D=365 H=700 mm

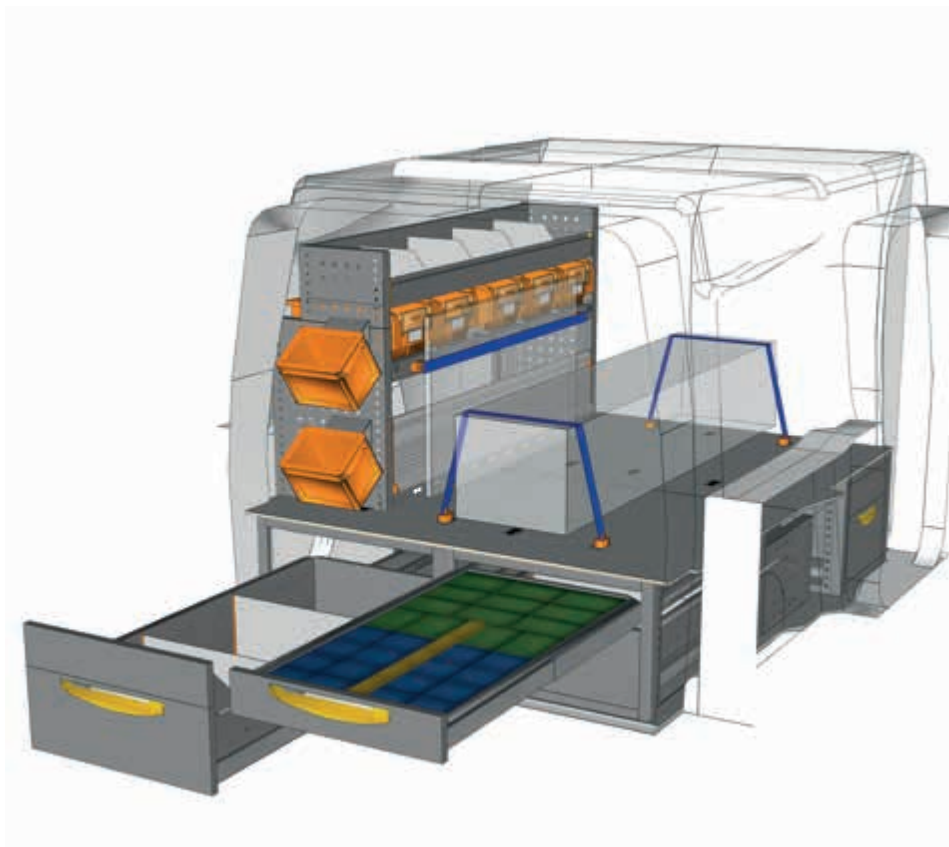
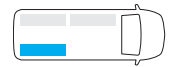

VOORBEELD - EXAMPLE

EXAMPLE PA L1H1 F2*

- 1 X PA 0350 02
- 1 X PA 1207 01
- 2 X E8 108058 B4
- 1 X E8 093058 G0
- 1 X E8 108042 B4
- 3 X V22124



Zie pagina's 10/11
see pages 10/11

* Inclusief bevestigingsmateriaal - Fixing kit included

Heeft u uw ideale inrichting niet gevonden?
Voor bedrijfswageninrichtingen op maat neemt u contact op met onze vakmensen.
Op de achterzijde vindt u de adresgegevens of bezoek onze website www.storevannederland.nl

Didn't find the equipment you're looking for?
Leave it to our experts.
See the back of this catalogue and contact the nearest StoreVan point or visit our website.



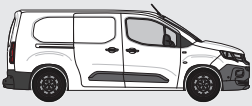

L2 H1

CITROËN BERLINGO
BEDRIJFSWAGEN - PANEL VAN

FLOOR UP 250

INRICHTINGSVOORBEELDEN - FITTINGS EXAMPLES

BODEMPLAAT H 250 mm – FLOORING H 250 mm

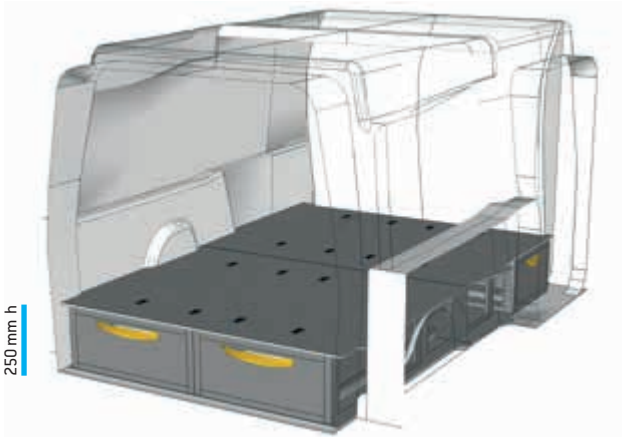

VOORBEELD - EXAMPLE

PA 0250 21*

B=1421 T=1954 H=268 mm - W=1421 D=1954 H=268 mm
(alleen voor plaatstalen schotten / only for sheet steel bulkhead)



VOORBEELD - EXAMPLE

PA 0250 22*

B=1421 T=1954 H=268 mm - W=1421 D=1954 H=268 mm
(alleen voor plaatstalen schotten / only for sheet steel bulkhead)

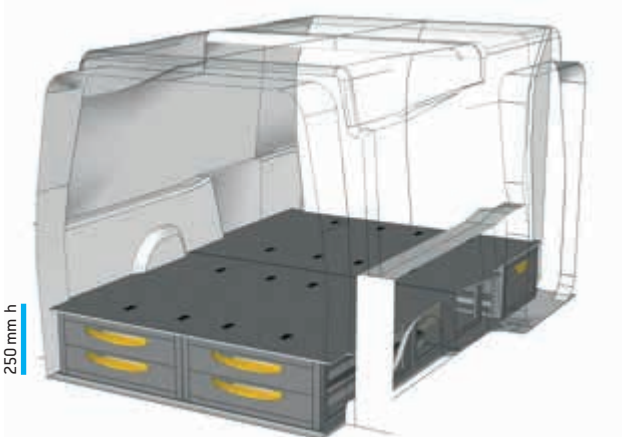

VOORBEELD - EXAMPLE

PA 0250 23*

B=1421 T=1954 H=268 mm - W=1421 D=1954 H=268 mm
(alleen voor plaatstalen schotten / only for sheet steel bulkhead)

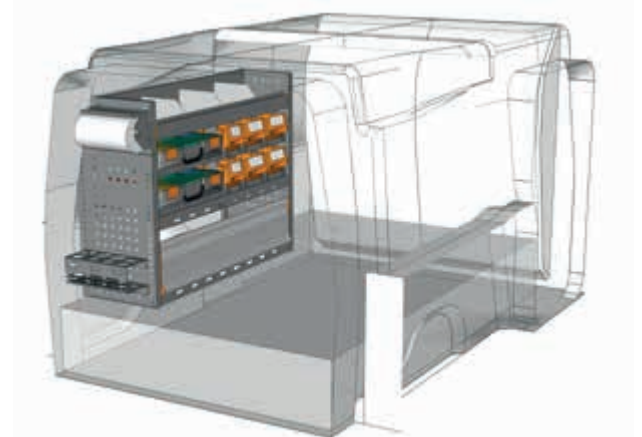

VOORBEELD - EXAMPLE

PA 1008 01*

B=1016 T=365 H=800 mm - W=1016 D=365 H=800 mm

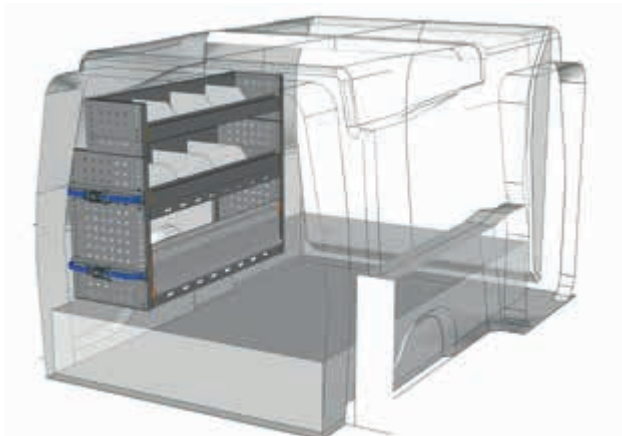

VOORBEELD - EXAMPLE

PA 1008 02*

B=1016 T=365 H=800 mm - W=1016 D=365 H=800 mm

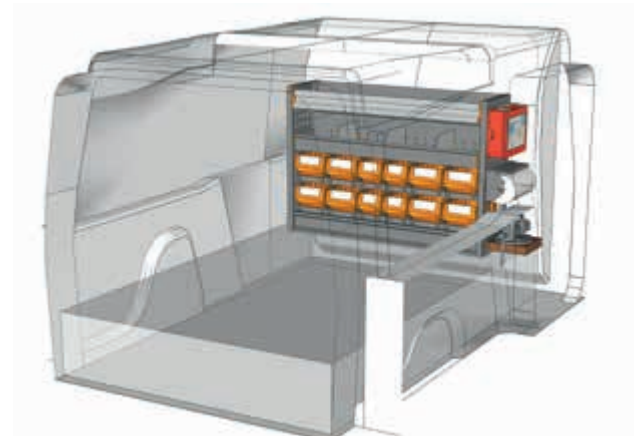
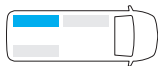

VOORBEELD - EXAMPLE

PA 1007 03*

B=1016 T=265 H=700 mm - W=1016 D=265 H=700 mm



* Inclusief bevestigingsmateriaal - Fixing kit included

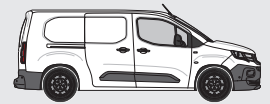

BODEMPLAAT H 250 mm – FLOORING H 250 mm

INRICHTINGSVOORBEELDEN - FITTINGS EXAMPLES

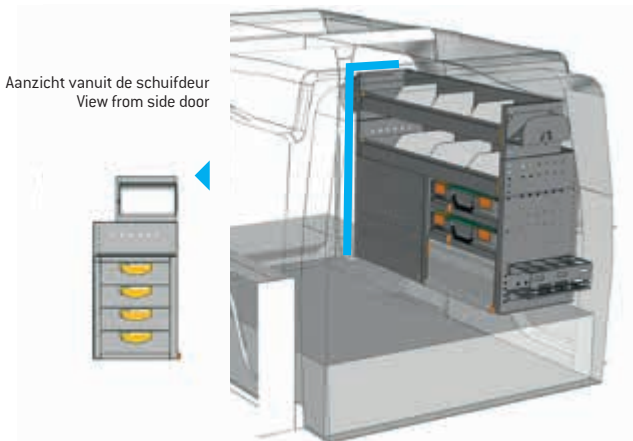

VOORBEELD - EXAMPLE

PA 1008 03*

B=1016 T=365 H=800 mm - W=1016 D=365 H=800 mm

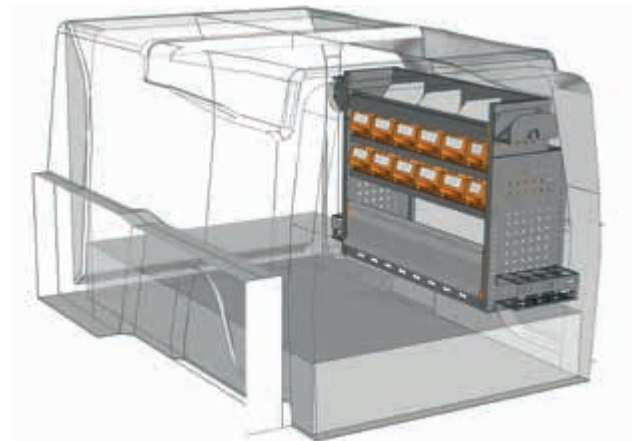

VOORBEELD - EXAMPLE

PA 1008 04*

B=1016 T=365 H=800 mm - W=1016 D=365 H=800 mm

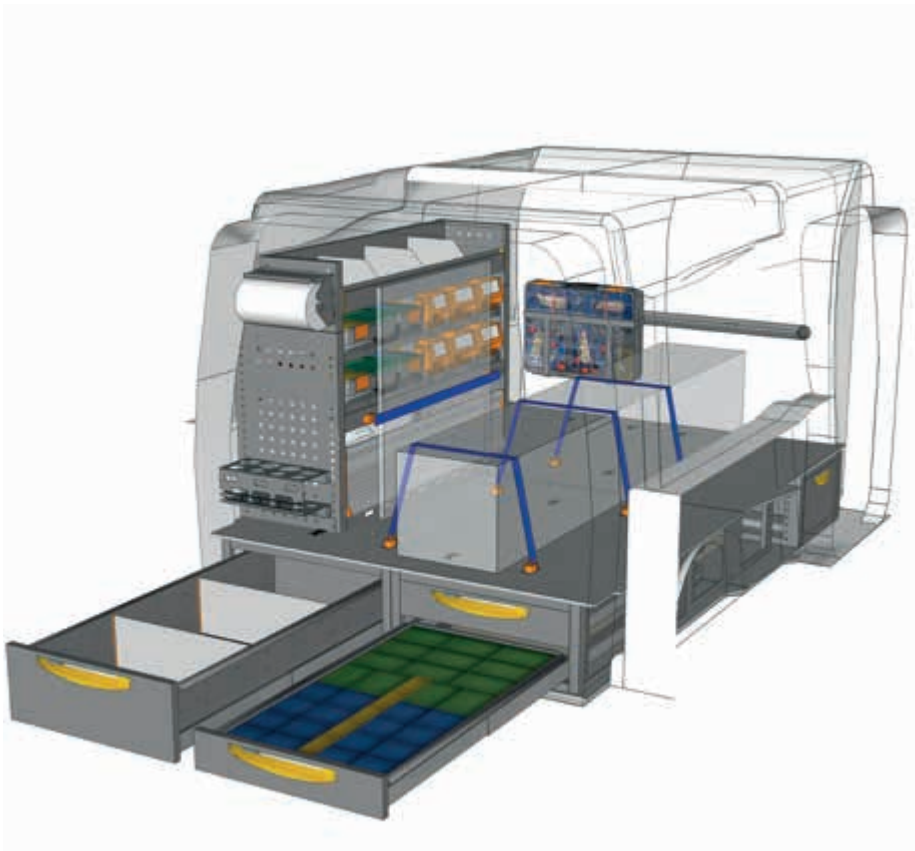
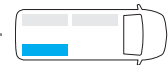

VOORBEELD - EXAMPLE

EXAMPLE PA L2H1 F1*

- | | |
|------------------|-------------|
| 1 x PA 0250 22 | 1 x BOX080 |
| 1 x PA 1008 01 | 1 x CPV080 |
| 1 x E8 108058 B4 | 2 x V22136 |
| 1 x E8 093058 F0 | 2 x V22124 |
| 1 x E8 093058 G0 | 2 x V22148 |
| 1 x E8 108042 B4 | 1 x YELLOW |
| 1 x V18029 10 | 4 x V225820 |
| 2 x V22106 | |



Zie pagina's 10/11
see pages 10/11

* Inclusief bevestigingsmateriaal - Fixing kit included

Heeft u uw ideale inrichting niet gevonden?
Voor bedrijfswageninrichtingen op maat neemt u contact op met onze vakmensen.
Op de achterzijde vindt u de adresgegevens of bezoek onze website www.storevannederland.nl

Didn't find the equipment you're looking for?
Leave it to our experts.
See the back of this catalogue and contact the nearest StoreVan point or visit our website.



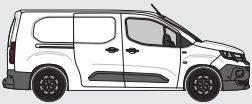

L2 H1

CITROËN BERLINGO
BEDRIJFSWAGEN - PANEL VAN

FLOOR UP 350

INRICHTINGSVOORBEELDEN - FITTINGS EXAMPLES

BODEMPLAAT H 350 mm – FLOORING H 350 mm

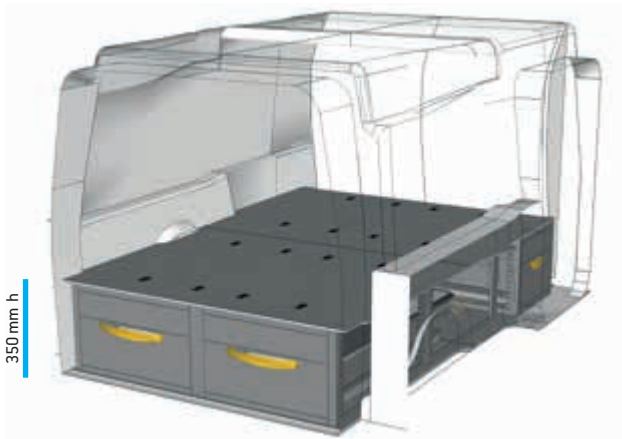

VOORBEELD - EXAMPLE

PA 0350 21*

B=1420 T=1927 H=368 mm - W=1420 D=1927 H=368 mm
(alleen voor plaatstalen schotten / only for sheet steel bulkhead)

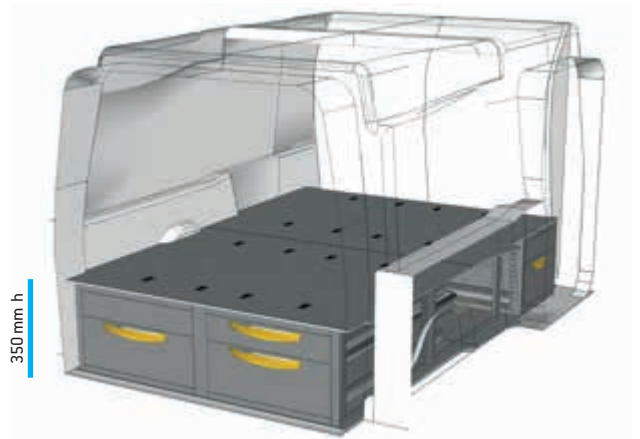

VOORBEELD - EXAMPLE

PA 0350 22*

B=1420 T=1927 H=368 mm - W=1420 D=1927 H=368 mm
(alleen voor plaatstalen schotten / only for sheet steel bulkhead)

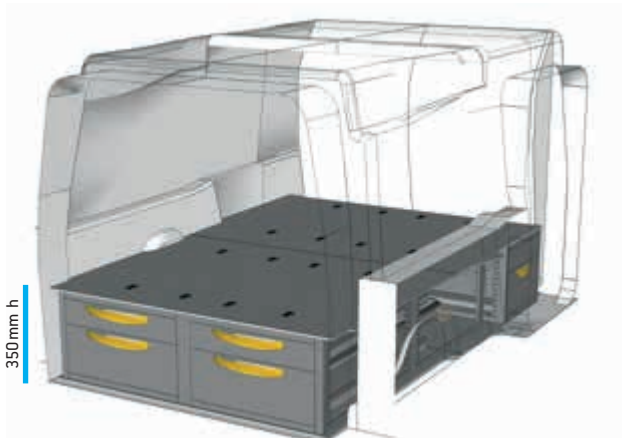

VOORBEELD - EXAMPLE

PA 0350 23*

B=1420 T=1927 H=368 mm - W=1420 D=1927 H=368 mm
(alleen voor plaatstalen schotten / only for sheet steel bulkhead)

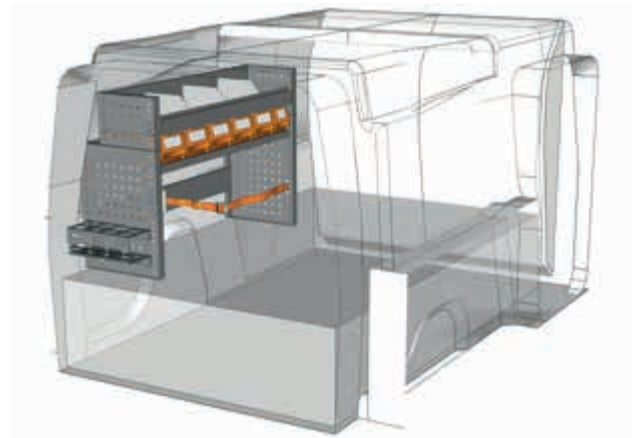

VOORBEELD - EXAMPLE

PA 1007 04*

B=1016 T=365 H=700 mm - W=1016 D=365 H=700 mm

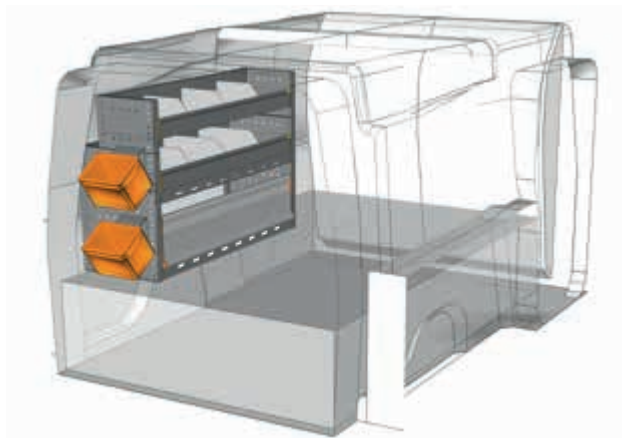
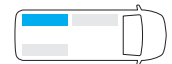

VOORBEELD - EXAMPLE

PA 1007 05*

B=1016 T=365 H=700 mm - W=1016 D=365 H=700 mm

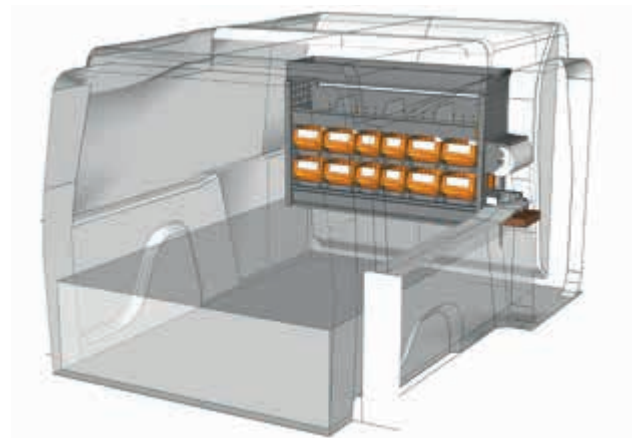

VOORBEELD - EXAMPLE

PA 1007 06*

B=1016 T=265 H=700 mm - W=1016 D=265 H=700 mm



* Inclusief bevestigingsmateriaal - Fixing kit included

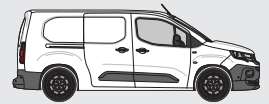

BODEMPLAAT H 350 mm – FLOORING H 350 mm

INRICHTINGSVOORBEELDEN - FITTINGS EXAMPLES

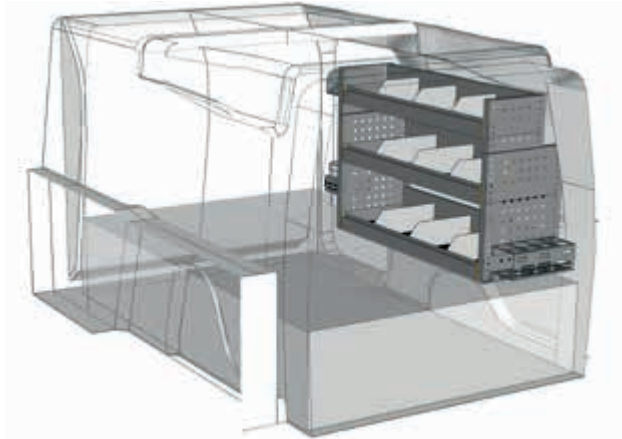

VOORBEELD - EXAMPLE

PA 1007 07*

B=1016 T=365 H=700 mm - W=1016 D=365 H=700 mm

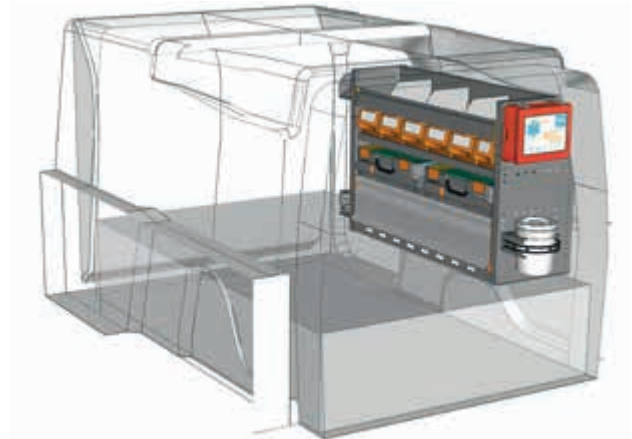
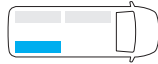

VOORBEELD - EXAMPLE

PA 1007 08*

B=1016 T=365 H=700 mm - W=1016 D=365 H=700 mm

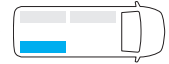

BEDRIJFSWAGEN - PANEL VAN
CITROËN BERLINGO

FLOOR UP 350

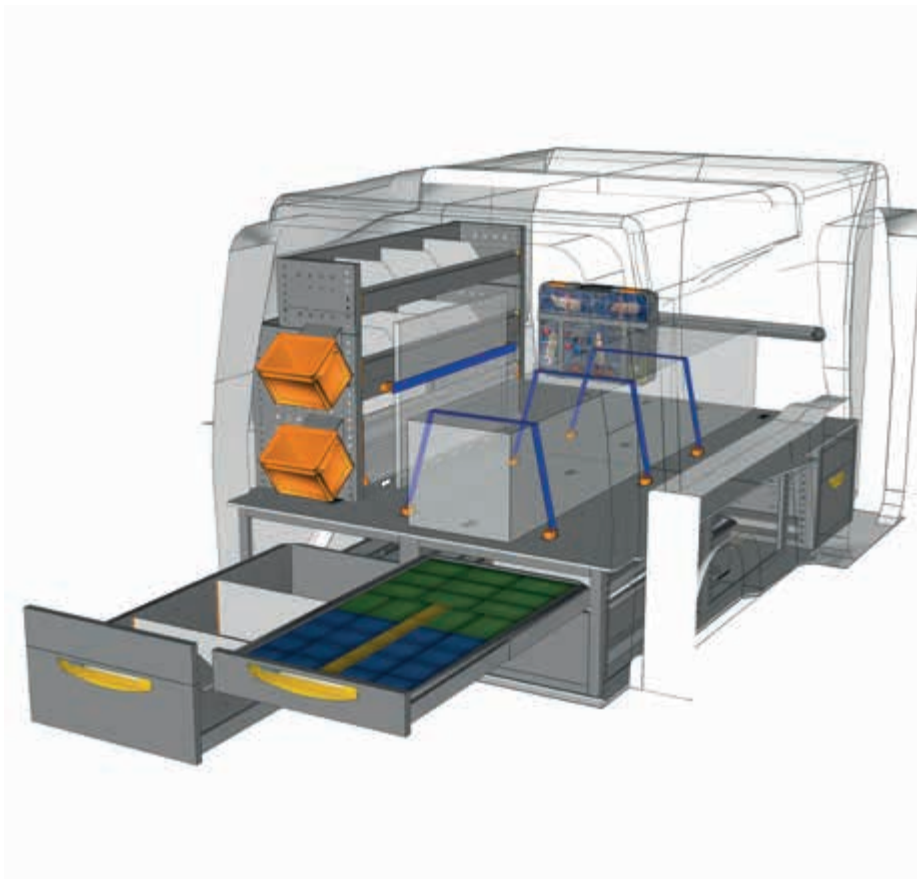

VOORBEELD - EXAMPLE

EXAMPLE PA L2H1 F2*

- | | |
|------------------|-------------|
| 1 x PA 0350 22 | 1 x CPV080 |
| 1 x PA 1007 05 | 2 x V22136 |
| 2 x E8 108058 B4 | 2 x V22124 |
| 1 x E8 093058 G0 | 2 x V22148 |
| 1 x E8 108042 B4 | 1 x YELLOW |
| 1 x V18029 10 | 4 x V225820 |
| 2 x V22106 | |
| 1 x BOX080 | |



Zie pagina's 10/11
see pages 10/11

* Inclusief bevestigingsmateriaal - Fixing kit included

Heeft u uw ideale inrichting niet gevonden?
Voor bedrijfswageninrichtingen op maat neemt u contact op met onze vakmensen.
Op de achterzijde vindt u de adresgegevens of bezoek onze website www.storevannederland.nl

Didn't find the equipment you're looking for?
Leave it to our experts.
See the back of this catalogue and contact the nearest StoreVan point or visit our website.



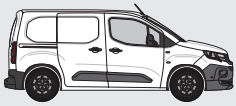

VOERTUIG VEHICLE	DAKDRAGER ROOF RACK	AFMETINGEN DIMENSIONS	GEWICHT WEIGHT	DRAAGVERMOGEN LOAD CAPACITY
	ART.			
Voertuigtype - Model L1 H1	POT 021	2250x1400 mm	22,85 kg	96,00 kg
Voertuigtype - Model L2 H1	POT 022	2750x1400 mm	27,75 kg	92,00 kg

- Alleen voor voertuigen met achterdeuren.
- Only for vehicle with rear leaf doors.

POT

- Dakdrager compleet met:
 - Aluminium dwarsliggers met bevestigingsonderdelen en rubberen profiel
 - Aluminium zijhekken
 - Aluminium geleidingsrol
 - Bevestigingsmaterialen in roestvrijstaal
- Roof rack complete of:
 - aluminium crossbars with fixing parts and rubber profile
 - aluminium side rails
 - aluminium loading roller
 - fixing screws in stainless steel



VOERTUIG VEHICLE	LADDERREK LADDER RACK	AFMETINGEN DIMENSIONS	GEWICHT WEIGHT	DRAAGVERMOGEN LOAD CAPACITY
	ART.			
Voertuigtype - Model L1 H1	POS 021	2250x1380 mm	46,95 kg	73,00 kg
Voertuigtype - Model L2 H1	POS 022	2750x1380 mm	54,35 kg	65,00 kg

- Alleen voor voertuigen met achterdeuren. De ladderrail kan aan de rechter- of linkzijde worden gemonteerd.
- Only for vehicle with rear leaf doors. The ladder rack rail can be mounted on the right or left side.

POS

- Ladderrek compleet met:
 - Aluminium dwarsliggers met bevestigingsonderdelen en rubberen profiel
 - Aluminium zijhek
 - Aluminium geleidingsrol
 - Ladderrail van aluminium en roestvrijstaal
 - Bevestigingsmaterialen in roestvrijstaal
- Ladder rack complete of:
 - aluminium crossbars with fixing parts and rubber profile
 - aluminium side rail
 - aluminium loading roller
 - ladder rack rail made of aluminium and stainless steel
 - fixing screws in stainless steel



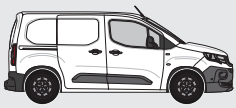

ART. NR. / ITEM NO. **PAP 265 00**

- Papierrolhouder met papier Ø 130 mm
- Paper towel holder kit with paper towel Ø 130 mm

ART. NR. / ITEM NO. **CAB 220 00**

- Slanghaspel
- Cable saddle

ART. NR. / ITEM NO. **SPR 365 00**

- Spuitbus- of kitpatroonhouder D=365 mm
- Spray-can holder kit D=365 mm

ART. NR. / ITEM NO. **PAP 365 00**

- Papierrolhouder met papier Ø 240 mm
- Paper towel holder kit with paper towel Ø 240 mm

ART. NR. / ITEM NO. **CAB 296 00**

- Slanghaspel kit
- Cable saddle-kit

ART. NR. / ITEM NO. **SIL 296 00**

- Spuitbus- en kitpatroonhouder
- Kit silicone - spray cans holder

ART. NR. / ITEM NO. **AID 265 00**

- EHBO-koffer
- First aid kit

ART. NR. / ITEM NO. **DOC 365 00**

- Documentenhouder A4 - 362x68x209 mm H
- A4 documents holder - 362x68x209 mm H

ART. NR. / ITEM NO. **SPR 160 00**

- Spuitbus- of kitpatroonhouder
- Spray-can holder kit (2 slots)

ART. NR. / ITEM NO. **LED 001 00**

- LED-lamp L=600 mm, IP20, 12V
- Led lamp IP20 12V W=600 mm

ART. NR. / ITEM NO. **WAS 365 00**

- Handenwaskit
- Hand wash kit

ART. NR. / ITEM NO. **WW MOBILE 1**

-
-

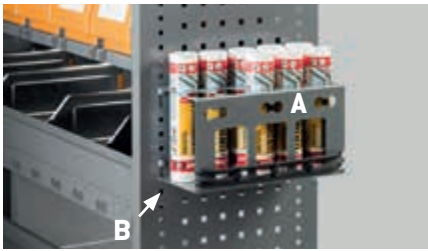
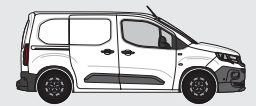

Kitpatron houder
Kit silicone holder

A + B

ART. NR. / ITEM NO. **BAR 296 00**

A

- Kokerhouder t.b.v. kitpatronen
- Support for silicone cartridges / threaded-bar holder

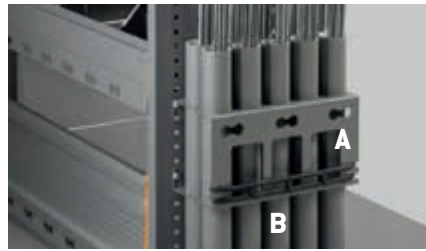

Kokerhouder t.b.v. draadeinden
Threaded-bar holder kit

A + B

ART. NR. / ITEM NO. **BAR 296 00**

A

- Kokerhouder t.b.v. draadeinden
- Support for silicone cartridges / threaded-bar holder

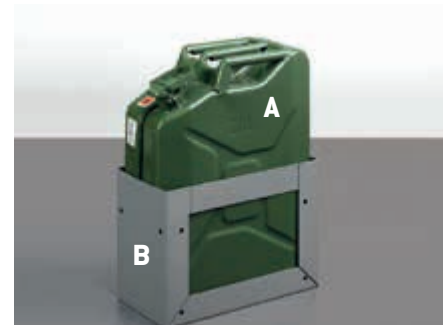

ART. NR. / ITEM NO. **OIL 20L 00**

A

- Jerrycanhouder incl. stalen jerrycan 20L
- Metal can capacity 20 LT

ART. NR. / ITEM NO. **BAR 296 02**

B

- Adapter t.b.v. kitpatronen
- Adapter for silicone cartridges

ART. NR. / ITEM NO. **BAR 296 01**

B

- Houder met 5 kokers voor draadeinden
- 5 Pipe for threaded-bar holder

ART. NR. / ITEM NO. **OIL 365 00**

B

- Jerrycanhouder
- Can holder

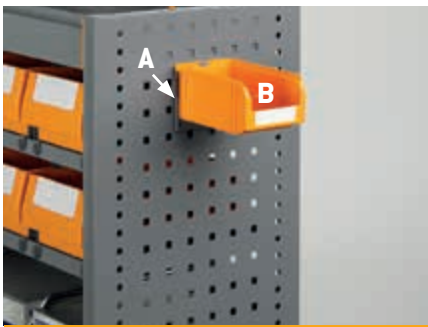

ART. NR. / ITEM NO. **BL 7433 00**

A

- Houder voor 1 container grootte 1PL
- Container rail for 1 container size 1PL

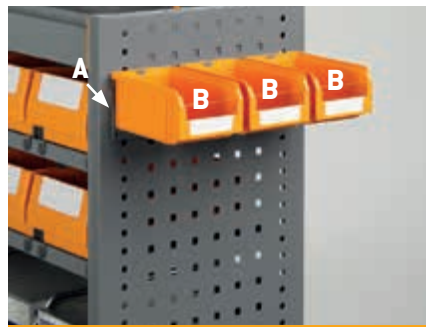

ART. NR. / ITEM NO. **BL 7434 00**

A

- Houder voor 3 containers grootte 1PL
- Container rail for 3 containers size 1PL

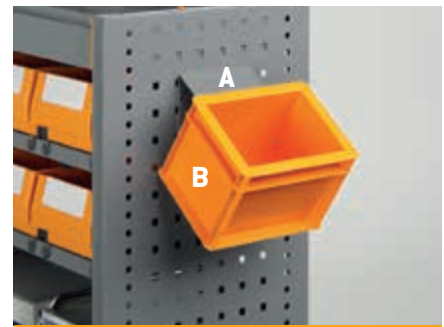

ART. NR. / ITEM NO. **BL 7432 00**

A

- Houder voor 1 Euro Box container
- Container rail for 1 container Euro Box

ART. NR. / ITEM NO. **PM 1751 00**

B

- Polypropyleen container grootte 1PL
- Polypropylene container size 1PL

ART. NR. / ITEM NO. **PM 1751 00**

B

- Polypropyleen container grootte 1PL
- Polypropylene container size 1PL

ART. NR. / ITEM NO. **PA 2251 A0**

B

- Polypropyleen Euro Box container
- Polypropylene boxes series Euro Box



ART. NR. / ITEM NO. **MAG 020**

- Set à 10 magneten Ø 20 mm
- Set of 10 magnets Ø 20 mm



ART. NR. / ITEM NO. **RUB 160 00**

- Anti-slip mat holder - 158x50x171 mm H
- Non-slip mats holder - 158x50x171 mm H



GEBRUIK VAN DE ANTI-SLIP MAT

Anti-slip matten worden gebruikt om de coëfficiënt van de wrijving te verhogen tot μD 0.6 volgens de DIN EN 12195-1: 2004 en VDI 2700 ff norm. De meetmethode moet de richtlijn "VDI 2700 pagina 15" volgen.

USE CASE FOR NON-SLIP MAT

Non-slip mats are used to increase the coefficient of friction up to μD 0.6 following the calculus DIN EN 12195-1: 2004 and VDI 2700 ff. The measuring procedure should follow the directive "VDI 2700 - 15".

ART. NR. / ITEM NO. **MAG 025**

- Set à 10 magneten Ø 25 mm
- Set of 10 magnets Ø 25 mm

ART. NR. / ITEM NO. **RUB 000 00**

- 6 anti-slip matjes - 150x150x3 mm H
- 6 non-slip mats kit - 150x150x3 mm H

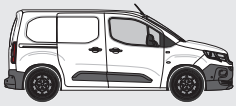

ART. NR. / ITEM NO. **FIR 000** **A**

- Houder met sjoband voor flessen en/of brandblussers
- Gas cylinder kit



ART. NR. / ITEM NO. **V18029 03** **A**

- All Safe Bar met middelgroot gat L=365 mm
- Horizontal load restraining bar with medium hole connector W=365 mm

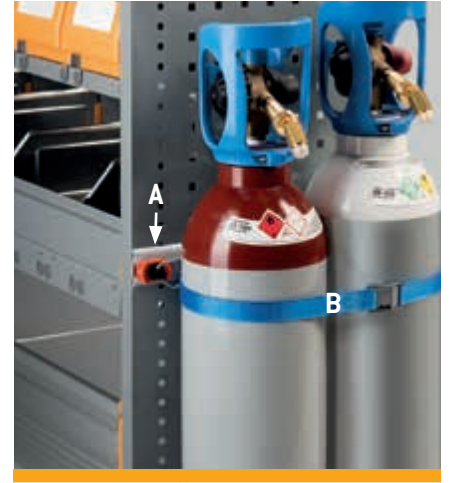

ART. NR. / ITEM NO. **V18029 03** **A**

- All Safe Bar met connector L=365 mm
- Horizontal load restraining bar with medium hole connector W=365 mm

ART. NR. / ITEM NO. **FIR 4KG** **B**

- Brandblusser 4kg
- Fire extinguisher [powder] 4 KG

ART. NR. / ITEM NO. **V18029 04** **A**

- All Safe Bar met middelgroot gat L=445 mm
- Horizontal load restraining bar with medium hole connector W=445 mm

ART. NR. / ITEM NO. **V18029 04** **A**

- All Safe Bar met connector L=445 mm
- Horizontal load restraining bar with medium hole connector W=445 mm

ART. NR. / ITEM NO. **V22868** **B**

- Medium sjoband met ratel t.b.v. All Safe Bar.
- Medium connector ratchet load restraining belt

ART. NR. / ITEM NO. **V22869** **B**

- Medium sjoband met snapsluiting
- Medium connector clamp load restraining belt

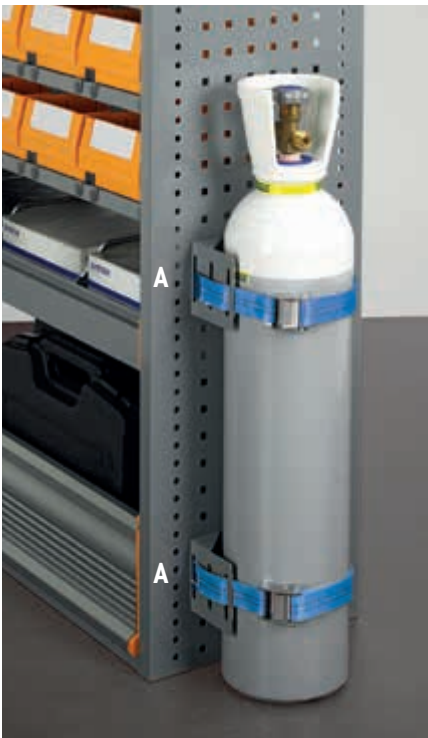

Voorbeeld met
2 ART.NR FIR 000
Example with
2 ITEM NO. FIR 000

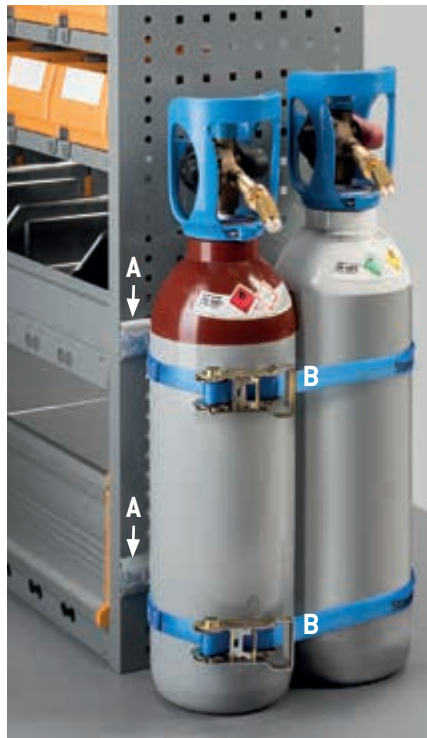

Voorbeeld met
2 ART.NR V18029 03
2 ART.NR V22868
Example with
2 ITEM NO. V18029 03
2 ITEM NO. V22868



Voorbeeld met
2 ART.NR V18029 03
2 ART.NR V22869
Example with
2 ITEM NO. V18029 03
2 ITEM NO. V22869

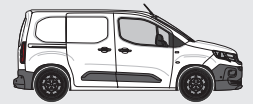

ART. NR. / ITEM NO. **00 ROLL SU** A

- Draagset t.b.v. Store Box Roll
- Set of supports for STORE BOX ROLL

ART. NR. / ITEM NO. **00 ROLL 00** B

- Trolley met wielen en remmen t.b.v. Store Box 102/136/238/374
- Trolley with castors with brakes for tool case BOX 102-136-238-374



CITROËN BERLINGO

LEVERINGSVOORWAARDEN

- Wandbekleding en bodemplaten worden als losse pakketten geleverd.
- Dak- en ladderrekken worden **flat-packed** (prefab) geleverd.
- Modules worden **geprefabriceerd** en compleet **met bevestigingsmaterialen** geleverd.
- **Gecertificeerde montage** door gecertificeerde technici mogelijk.
- Producten worden **verpakt** geleverd.
- **3 jaar garantie** op de inrichtingen van Store Van.
- De genoemde draagvermogens in deze brochure hebben betrekking op **gelijkmatig verdeelde last**.

SUPPLY CONDITIONS

- Flooring and linings supplied in several pieces.
- Roof and ladder racks supplied **flat-packed**.
- Modules are supplied **preassembled** complete of fixing material to the vehicle.
- For products installation, please get in touch with our **approved installer's network**.
- Products provided **with packaging**.
- Our products are covered by a **3-years warranty**.
- Load capacities refer to **uniformly distributed loads**.



FAMI S.R.L.

VIA STAZIONE ROSSANO, 13 – 36027 ROSÀ (VI) ITALY
TEL +39 0424 585455 R.A. – FAX +39 0424 585482
INFO@FAMISPA.COM – WWW.FAMISPA.COM

INFO@STOREVAN.COM – WWW.STOREVAN.COM

STOREVANNEDERLAND IS EEN DIVISIE VAN:
KÜSTER-EFFORT B.V. - T. 088 – 1301 400
E. INFO@STOREVANNEDERLAND.NL - WWW.STOREVANNEDERLAND.NL
VOLG ONS OP FACEBOOK, INSTAGRAM EN LINKEDIN

