



FAHRZEUGEINRICHTUNGEN
FITTINGS FOR COMMERCIAL VEHICLES



LIGHT SHELF

KLAPPREGALE FÜR TRANSPORTER
FOLDABLE VAN SHELVING SYSTEM





StoreVan ist weltweit der einzige Hersteller von Nutzfahrzeugeinrichtungen, der mit dieser Technologie arbeitet.

StoreVan is the sole LCV's equipment manufacturer worldwide to make use of this technology.

TECHNOLOGIE

GALVANNEALED STAHL

Galvannealed Blech ist eine Variante von feuerverzinktem Blech. Das Produkt unterliegt einem Feuerbeschichtungsprozess und wird bis ca. 550 °C erhitzt. Dies ermöglicht es dem Zink mit dem Stahlblech eine Legierung einzugehen. Das Ergebnis ist eine Beschichtung mit einer gleichförmigen, feinkörnigen Kristallstruktur an der Beschichtungsoberfläche und einer **sehr hohen Oberflächenqualität und Korrosionsbeständigkeit**.

Dieses Verfahren ist ideal für Automotive Anwendungen. StoreVan hat diese Technik nun auch im Bereich Nutzfahrzeugeinrichtungen implementiert.

DAS VERFAHREN DER KATHODISCHEN ACRYL-TAUCHLACKIERUNG

Die kathodische Acryl-Beschichtung ist eine Oberflächenbehandlung, die den einzelnen Teilen der Einrichtung eine **extrem hohe Korrosionsbeständigkeit** verleiht. Das Tauchverfahren gewährleistet eine **gleichmäßige Beschichtung** und einen lang anhaltenden Schutz egal gegen welche Stoffe. Das Acrylharz schützt den Lack bei direkter Belichtung durch die Witterung gegen Ausbleichen und gegen Veränderungen der Korrosionsbeständigkeit.

- Korrosionsbeständigkeit von über 500 Stunden (ASTM D1735 Luftfeuchtigkeit)
- Ausgezeichnete Härte mit einem Mindestrating von 2H



STORE VAN ORANGE PLANET

Nachhaltigkeit und ökologische Entwicklung sind Themen von großem, aktuellem Interesse, entstanden durch das steigende Bewusstsein, dass auf die Umweltbalance aufgrund der zyklischen Veränderungen und Erneuerungen geachtet werden muss.

STORE VAN ORANGE PLANET

Environmental sustainability and eco-compatible development are topics of great interest and relevance, arising from the growing awareness that it is important to pay attention to the environmental balance.

TECHNOLOGIES

GALVANNEALED STEEL

Galvannealed sheet is a variant of hot-dip galvanized sheet. The product is subject to a hot-dip galvanization process and subsequently heated to approximately 550°C, combining the zinc with the sheet surface to make an alloy with iron. The result is a uniform zinc coating with a fine-grained crystalline structure along with a **much higher surface quality and corrosion resistance**. This process is ideal for automotive applications. StoreVan has introduced and implemented this technology in the commercial vehicles equipment field.

CATHODIC DIP PAINTING WITH ACRYLIC RESIN

Cataphoresis painting is a paint surface treatment able to give the equipment elements a **remarkable resistance to corrosion**; characterized by **uniform deposit** of an acrylic resin on the element surface, it ensures long lasting, high protection against chemical agents and other types of surface attacks. The acrylic resin allows a direct exposure to atmospheric agents without altering its technical features. This process ensures an increased protection against rust.

- Corrosion resistance of more than 500 hours (humidity ASTM D1735)
- Excellent hardness with a minimum rating of 2H



FLEXIBLES BEFESTIGUNGSSYSTEM

FLEXIBLE FIXING SYSTEM

DIE FLEXIBILITÄT UND DAUERHAFTIGKEIT DER STORE VAN TRANSPORTEREINRICHTUNGEN

Store Van benutzt zur Befestigung der Transporterregale am Fahrgestell des Nutzfahrzeuges ein spezielles Schienensystem und sorgt damit für eine besonders flexible Positionierbarkeit der Module und eine maximale Nutzung der Innenräume des ausgestatteten Transporters.

Bei diesem System werden Bügel benutzt, die in der Gesamtlänge der Schiene gleiten, anstatt direkt an den Verstärkungen des Fahrgestells angenietet zu sein, was beim Entwurf der Transportereinrichtung grundsätzlich zu einer starren Raumnutzung zwingt. Die von Store Van verwendete Schiene wird an die vertikalen Pfosten der mobilen Werkstatt befestigt und hat die doppelte Funktion einer gleichmäßigen Verbindung der Transporterregale am Fahrzeugrahmen und einer homogenen Verteilung aller dynamischen Kräfte, denen die Einrichtung während der Fahrt ausgesetzt ist.

Die Befestigungsbügel für die Verbindung der Schiene am Modul besitzen ein spezielles Gelenk, das die bei der Fahrt verursachten Vibrationen dämpft, indem es sich den Torsionsbewegungen des Fahrgestells anpasst, vor allem beim Kurvenfahren.

Dieses System bietet beim Entwurf unserer Transportereinrichtungen eine erhebliche Gestaltungsfreiheit, wobei in jedem Fall hohe Sicherheits-, Stabilitäts- und Dauerhaftigkeitsstandards garantiert werden.

Bei allen unseren Befestigungssystemen können für die Module Schnellankupplungs- und -loskupplungssysteme mit Feststellgriffen eingesetzt werden, die eine werkzeuglose Demontage der Einrichtung ermöglichen. Dadurch kann das Regal Ihrer mobilen Werkstatt, wie in der RICHTLINIE 2014/47 EU, KAP. 1, Artikel 3, Absatz 5 beschrieben, als transportiertes Material oder als Hilfsmittel für die Sicherheit der nicht dauerhaft am Fahrzeug befestigten Ladung erklärt werden.

FLEXIBILITY AND DURABILITY OF STORE VAN EQUIPMENT

Store Van uses a special rail anchoring system to secure shelving units for vans to the chassis of your vehicle, improving the flexibility of module arrangement and maximising the internal spaces of your van.

This system is based on brackets sliding all along the rail rather than being riveted to chassis reinforcements, thus offering great flexibility in the management of internal spaces. The Store Van rail is secured to the uprights of your mobile workshop and has a two-fold function: it connects shelving units uniformly to the frame of your vehicle, and it evenly distributes all the dynamic forces your van equipment is subject to while travelling. Special vibration damping joints, fitted on the brackets connecting the rail to the module, absorb the torsional vibration applied on the chassis especially when driving on a curve.

Thanks to this system, our fittings for vans can be designed with maximum freedom, always ensuring high safety, stability and durability standards.

Our anchoring systems are fitted with quick locking/unlocking devices with adjustable handles, so users can remove the fittings with no need of tools. Hence the shelving units of your mobile workshop may be considered as transported goods or load securing fittings not permanently fixed to the vehicle, in compliance with Directive 2014/47EU, Chapter 1, Article 3, Item 5.



ZERTIFIZIERUNGEN CERTIFICATIONS

ZERTIFIZIERTE PRODUKTION

- Nach ISO 9001:2015 zertifiziert.
- Erfolgreicher CRASH TEST durchgeführt nach ECE-R17 mit einer Aufprallgeschwindigkeit von 50 Km/h.
- GS-Zertifizierung für Inneneinrichtungen und Laderampen.
- GS-Zertifizierung für Dachträger und Leiterträger.

CERTIFIED PRODUCTION

- ISO 9001:2015 certified.
- Brilliantly passed the CRASH TEST carried out according to the most recent European regulations ECE-R17 with impact at 50 Km/h.
- GS certification for interior fittings and loading ramps.
- GS certification for roof and ladder racks.

CRASH TEST
ECE-R17





FRONT

FRONT

CHEST FREEZER
Arcón Congelador
Congelatore a pozzetto
Gefriertruhe / Морозильный ларь

CHEST FREEZER
StoreVan

Arcón Congelador / Congelatore a pozzetto
Gefriertruhe / Морозильный ларь



Fiat *Ducato*
Peugeot *Boxer*
Citroën *Jumper*

14

Renault *Master*
Opel *Movano*
Nissan *NV400*

20

Volkswagen *Crafter*
Man *Tge*

24

Ford *Transit*

28

Mercedes-Benz *Sprinter*

32

LIGHT SHELF

LIGHT SHELF
KASTENWAGEN - PANEL VAN





KLAPPREGALE FÜR KURIER-, EXPRESS- UND PAKETDIENSTLEISTER (KEP), SPEDITIONSUNTERNEHMEN, VERKAUFWAGEN.

Für die Fahrzeugeinrichtung von Paketdiensten wie GLS – DHL – UPS – SDA, den Profis der Paketzustellung auf der letzten Meile, oder kleiner Unternehmen für den Transport verpackter Waren präsentiert Store Van **Light Shelf**, die Produktlinie von **Klappregalen für Transporter** der dritten Generation.

Die Klappregale Light Shelf werden seit vielen Jahren in Tausenden Paketdienst-Fahrzeugen mit hervorragenden Ergebnissen in puncto **Robustheit** und **Zuverlässigkeit** getestet.

Die in **verschiedenen Längen** verfügbaren und **je nach Kundenbedürfnissen konfigurierbaren** Klappregale ermöglichen die Optimierung und deutliche Erhöhung der Ladekapazität des Transporters. Bei dem Klappregalsystem **Light Shelf** kann man **bis zu 6 Regalböden übereinander** anordnen. Für einen absolut sicheren Transport der Ware sind zudem "airline"-Schienen zur Ladungssicherung mittels Gurten und Spannstangen einsetzbar.

FOLDABLE SHELVING SYSTEMS FOR EXPRESS COURIERS (CEP), FORWARDERS, STREET SELLERS' VANS.

For fitting out of express couriers, such as GLS – DHL – UPS – SDA, professional last mile package delivery services, or for small transport companies carrying packaged material, Store Van presents **Light Shelf**, the range of third-generation **foldable van shelving system**.

Light Shelf shelving systems have been tested for many years on thousands of vehicles used by express couriers with excellent results in terms of **sturdiness** and **reliability**.

Available in **various lengths and configurable to suit the customer's needs**, these foldaway shelves can be used to optimise and considerably increase the van's carrying capacity.

The system with **Light Shelf** tip-up shelves can house **up to 6 shelves in height** and also allows the addition of "airline" guides for anchoring the load with straps and steady-load bars, to transport the goods in total safety.



LIGHT SHELF

LIGHT SHELF
KASTENWAGEN - PANEL VAN





EIGENSCHAFTEN DER KLAPPREGALE

Konzipiert für den Transport von **Behältern und Kisten mit europäischen Standardmaßen** (400x300 mm und 600x400 mm) entspricht die Produktlinie von Klappregalen für Transporter Light Shelf auch perfekt den Anforderungen beim Transport von Ersatzteilen für Fahrzeuge, Elektrogeräte, Besteck und Geschirr für Catering-Dienste etc. Das vollständige oder teilweise Zuklappen der Regalböden ermöglicht außerdem den **Transport von Sperrgütern auf Europaletten**.

Light Shelf verwendet als Sicherheitsverriegelung einen speziellen Bolzen, der das **Aufklappen des Regalbodens mit nur einer Hand erlaubt**. Die Traglast pro Regalboden beträgt 80 Kg, die bei Verwendung spezieller Ständer **bis auf 120 kg** erhöht werden kann. Das Hängesystem der Klappregale Light Shelf **erfordert keinerlei Stahldrähte oder Gurte**, die oftmals bei der Längsanordnung der Pakete störend wirken. Dadurch können mehrere Regalböden auf derselben Ladehöhe lückenlos aneinandergereiht werden, was den **Transport besonders langer Güter** erleichtert.

SHELF FEATURES

Designed to transport **containers and boxes with standard European measurements** (400x300 mm and 600x400 mm), the Light Shelf range of van shelves also perfectly satisfies the needs for transporting replacement parts for vehicles, electrical household appliances, cutlery and crockery for catering services, etc. Complete or partial closure of the shelves also makes it possible to **transport voluminous goods on Euro-pallets**.

As a safety block, Light Shelf uses a special pin that allows **the Shelf to be opened with one hand**. The capacity of each Shelf is 80 Kg and this can be increased **up to 120 Kg** with use of special uprights. The Light Shelf suspension system **needs no steel wires or straps**, which are often an impediment in lengthwise arrangement of packages. This allows several shelves aligned at the same height to be transformed into a single surface, making it easy to **transport particularly long goods**.



Geschlossenes Regal in Position 1
Closed shelf in position 1



Geschlossenes Regal in Position 2
Closed shelf in position 2



Offenes Regal
Opened shelf

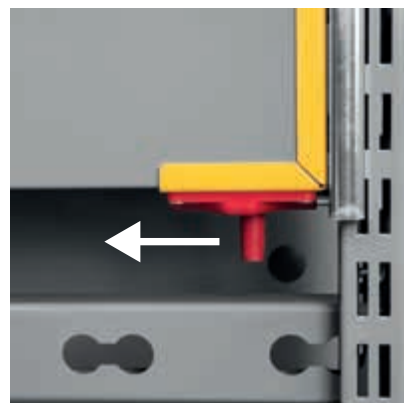

Einhändiges Öffnen des Regals
Opening shelf-system with one hand

LIGHT SHELF

LIGHT SHELF
KASTENWAGEN - PANEL VAN





VORTEILE DES KLAPPREGALSYSTEMS FÜR TRANSPORTER LIGHT SHELF:

- Bis zu 6 Regalböden übereinander;
- Vollständiges oder teilweises Zuklappen;
- Traglast bis zu 120 kg;
- Hängesystem **ohne** Stahldrähte oder Gurte;
- Ideal für den Langguttransport;
- Kompatibel mit Behältern mit europäischen Standardmaßen;
- Bohrlöcher in allen Regalböden zur Aufnahme und Befestigung von Standard-Trennelementen aus Aluminium h 50 mm oder von Trennbögen h 300 mm;
- Die Regalböden können eingestellt bzw. mit den seitlichen Steckelementen in 38 mm-Abständen in den Ständerbohrungen in der Höhe hinzugefügt werden;
- Alle Ränder und Bohrungen sind frei von scharfen Kanten;
- Die KTL-Beschichtung der Regalböden (in der Automobilbranche verbreitete Technologie) verleiht einen hohen Korrosionsschutz und eine erhöhte chemische Beständigkeit im Vergleich zu herkömmlichen Lackierverfahren mit Entfettung und Pulverbeschichtung;
- Es können rutschfeste Matten eingelegt werden.

BENEFITS OF THE LIGHT SHELF FOLDABLE VAN SHELVING SYSTEM:

- Up to 6 shelves in height;
- Total or partial closure;
- Capacity up to 120 kg;
- Suspension system **with no** steel wires or straps;
- Ideal for transporting long goods;
- Compatible with containers with standard European measurements;
- Holes on all shelves for housing and fastening standard aluminium partitions h 50 mm or arched partitions h 300 mm;
- Possibility of adjusting or adding shelves in height at a distance of 38 mm, due to side brackets interlocked into the perforated uprights;
- No sharp corners on all edges and holes;
- Cathaphoresis immersion coating of shelves (technology widely used in the car industry) to allow better resistance to corrosion and chemical agents than traditional phospho-degreasing and polyester powder;
- Possibility of inserting anti-slip mat.



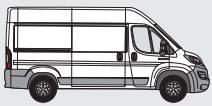

FAHRZEUGEINRICHTUNGSBEISPIELE - FITTINGS EXAMPLES



BEISPIEL - EXAMPLE

DU 2618 L1*

B=2620 T=430 H=1772 mm - W=2620 D=430 H=1772 mm

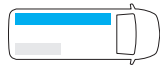

BEISPIEL - EXAMPLE

DU 2618 L2*

B=2620 T=430 H=1772 mm - W=2620 D=430 H=1772 mm

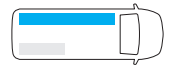

BEISPIEL - EXAMPLE

DU 2618 L3*

B=2620 T=430 H=1772 mm - W=2620 D=430 H=1772 mm

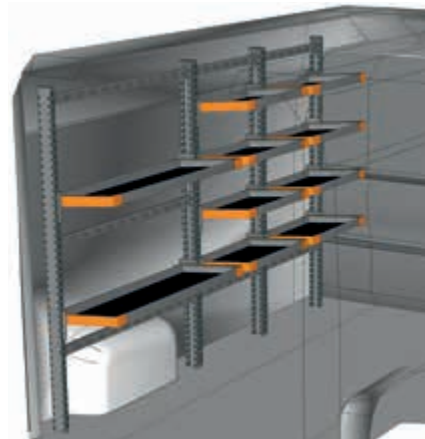
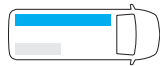

BEISPIEL - EXAMPLE

DU 2618 L4*

B=2659 T=430 H=1772 mm - W=2659 D=430 H=1772 mm

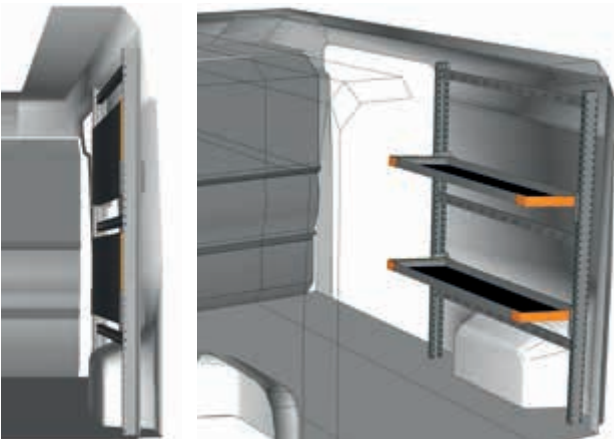

BEISPIEL - EXAMPLE

DU 1318 L1*

B=1310 T=430 H=1772 mm - W=1310 D=430 H=1772 mm

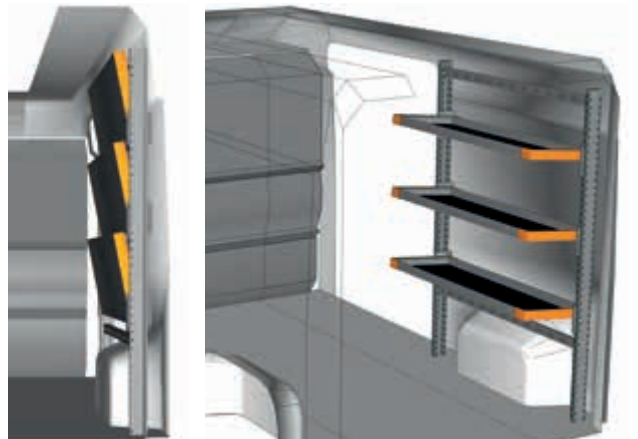
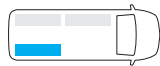

BEISPIEL - EXAMPLE

DU 1318 L2*

B=1310 T=430 H=1772 mm - W=1310 D=430 H=1772 mm



* Einschließlich Befestigungskit - Fixing kit included

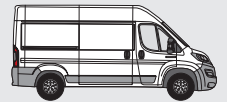

FAHRZEUGEINRICHTUNGSBEISPIELE - FITTINGS EXAMPLES



BEISPIEL - EXAMPLE

EXAMPLE DU L2H2 L1 (*) (**)



- | | |
|-------------------------|-------------------------|
| 1 x DU 2618 L4 | 1 x F22 SB BOX080 00 01 |
| 6 x F22 LS 445D30 00 99 | 1 x F22 SB CPV080 00 01 |
| 1 x F22 SF DU20G1 A0 1S | 2 x F22 FC V22136 00 00 |
| 1 x F22 VT V22585 00 08 | 2 x F22 FC V22124 00 00 |
| 6 x F22 FC V22017 00 00 | 2 x F22 FC V22148 00 00 |
| 2 x F22 FC V18029 15 00 | 1 x F22 SB YELLOW 63 05 |
| 1 x F22 FC V18029 10 00 | 4 x F22 FC V22582 00 00 |
| 6 x F22 FC V22106 00 00 | |
| 3 x F22 FC V18025 15 00 | |

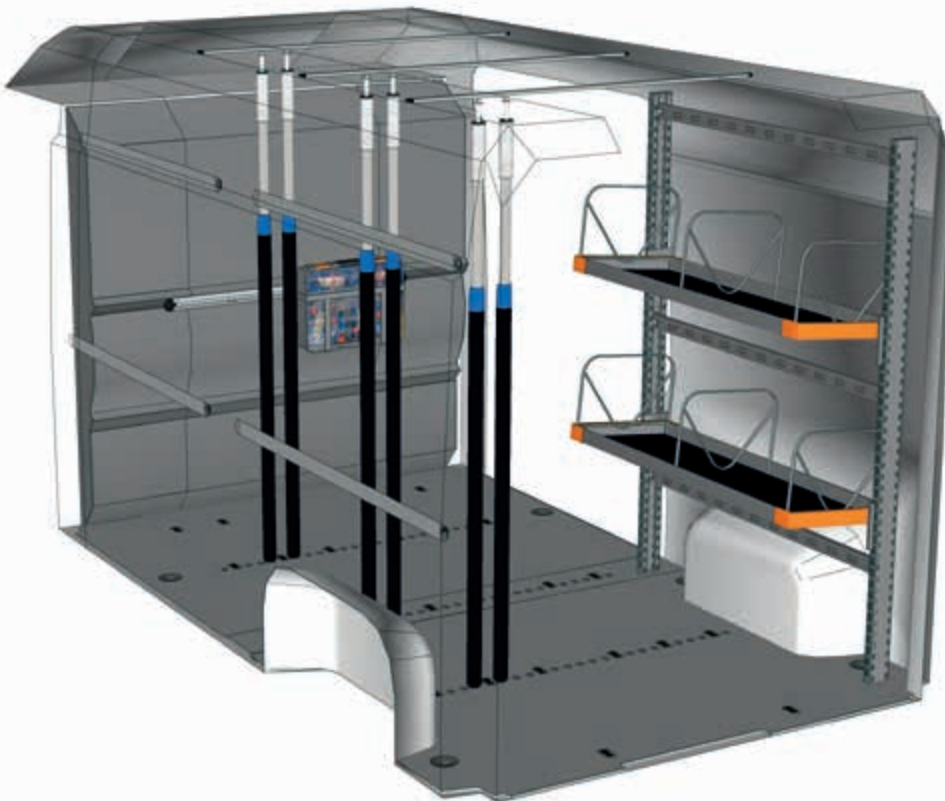

BEISPIEL - EXAMPLE

EXAMPLE DU L2H2 L2*



- | | |
|--------------------------|-------------------------|
| 1 x DU 1318 L1 | 1 x F22 SB BOX080 00 01 |
| 6 x F22 LS 445D30 00 99 | 1 x F22 SB CPV080 00 01 |
| 1 x F22 SF DU20G1 A0 1S | 2 x F22 FC V22136 00 00 |
| 1 x F22 VT V22585 00 08 | 2 x F22 FC V22124 00 00 |
| 6 x F22 FC V22017 00 00 | 2 x F22 FC V22148 00 00 |
| 4 x F22 FC V18029 15 00 | 1 x F22 SB YELLOW 63 05 |
| 1 x F22 FC V18029 10 00 | 4 x F22 FC V22582 00 00 |
| 10 x F22 FC V22106 00 00 | |
| 3 x F22 FC V18025 15 00 | |



* Einschließlich Befestigungskit - Fixing kit included

** Ohne Behälter - Containers not included

Haben Sie Ihre Einrichtung nicht gefunden?
Verlassen Sie sich auf die Profis für Fahrzeugeinrichtungen.
 Auf der Rückseite dieses Katalogs finden Sie die nächstgelegene StoreVan Niederlassung. Besuchen Sie unsere Web-Seite.

Didn't find the equipment you're looking for?
Leave it to our experts.
 See the back of this catalogue and contact the nearest StoreVan point or visit our website.



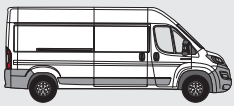

FAHRZEUGEINRICHTUNGSBEISPIELE - FITTINGS EXAMPLES

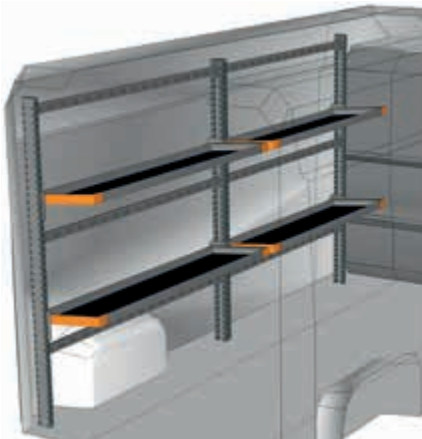

BEISPIEL - EXAMPLE

DU 3218 L1*

B=3257 T=430 H=1772 mm - W=3257 D=430 H=1772 mm

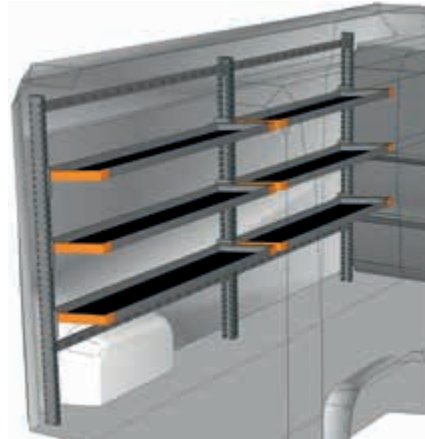
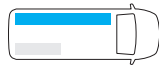

BEISPIEL - EXAMPLE

DU 3218 L2*

B=3257 T=430 H=1772 mm - W=3257 D=430 H=1772 mm

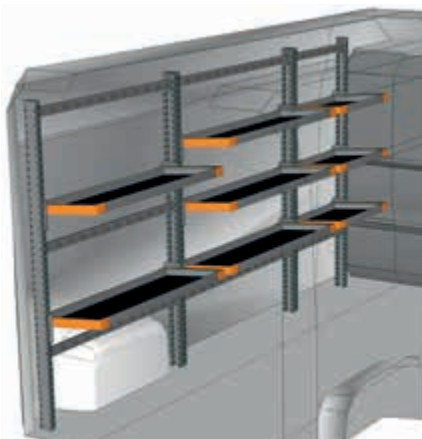
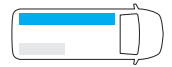

BEISPIEL - EXAMPLE

DU 3218 L3*

B=3252 T=430 H=1772 mm - W=3252 D=430 H=1772 mm

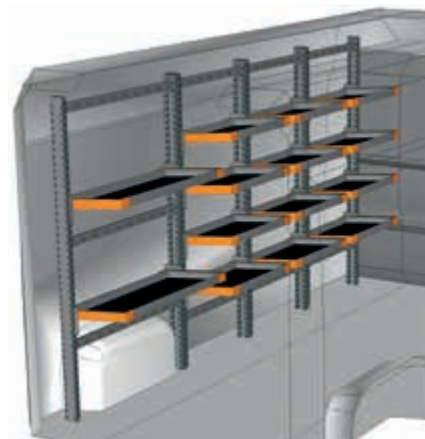
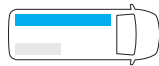

BEISPIEL - EXAMPLE

DU 3218 L4*

B=3167 T=430 H=1772 mm - W=3167 D=430 H=1772 mm

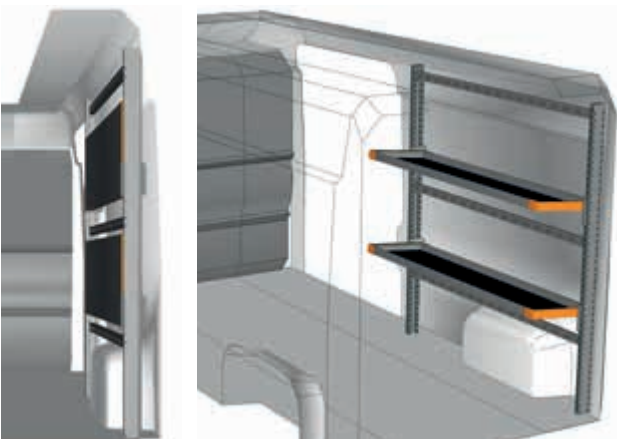
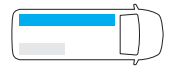

BEISPIEL - EXAMPLE

DU 1718 L1*

B=1733 T=430 H=1772 mm - W=1733 D=430 H=1772 mm

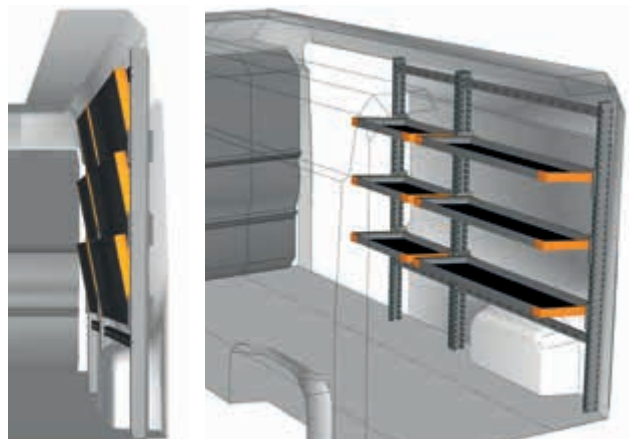
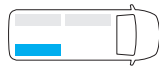

BEISPIEL - EXAMPLE

DU 2018 L1*

B=2027 T=430 H=1772 mm - W=2027 D=430 H=1772 mm



* Einschließlich Befestigungskit - Fixing kit included

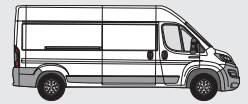

FAHRZEUGEINRICHTUNGSBEISPIELE - FITTINGS EXAMPLES

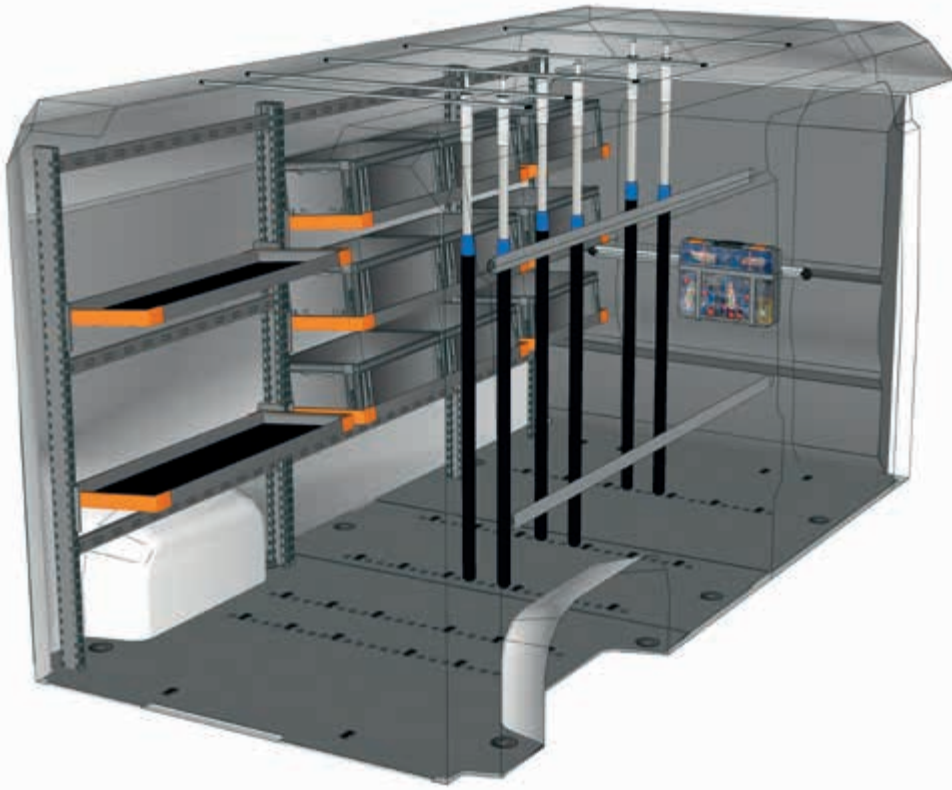

BEISPIEL - EXAMPLE

EXAMPLE DU L4H2 L1 (*) (**)



- | | |
|-------------------------|-------------------------|
| 1 x DU 3218 L3 | 1 x F22 SB CPV080 00 01 |
| 1 x F22 SF DU30G1 A0 1S | 2 x F22 FC V22136 00 00 |
| 1 x F22 VT V22585 00 08 | 2 x F22 FC V22124 00 00 |
| 6 x F22 FC V22017 00 00 | 2 x F22 FC V22148 00 00 |
| 2 x F22 FC V18029 20 00 | 1 x F22 SB YELLOW 63 05 |
| 1 x F22 FC V18029 10 00 | 4 x F22 FC V22582 00 00 |
| 6 x F22 FC V22106 00 00 | |
| 5 x F22 FC V18025 15 00 | |
| 1 x F22 SB BOX080 00 01 | |

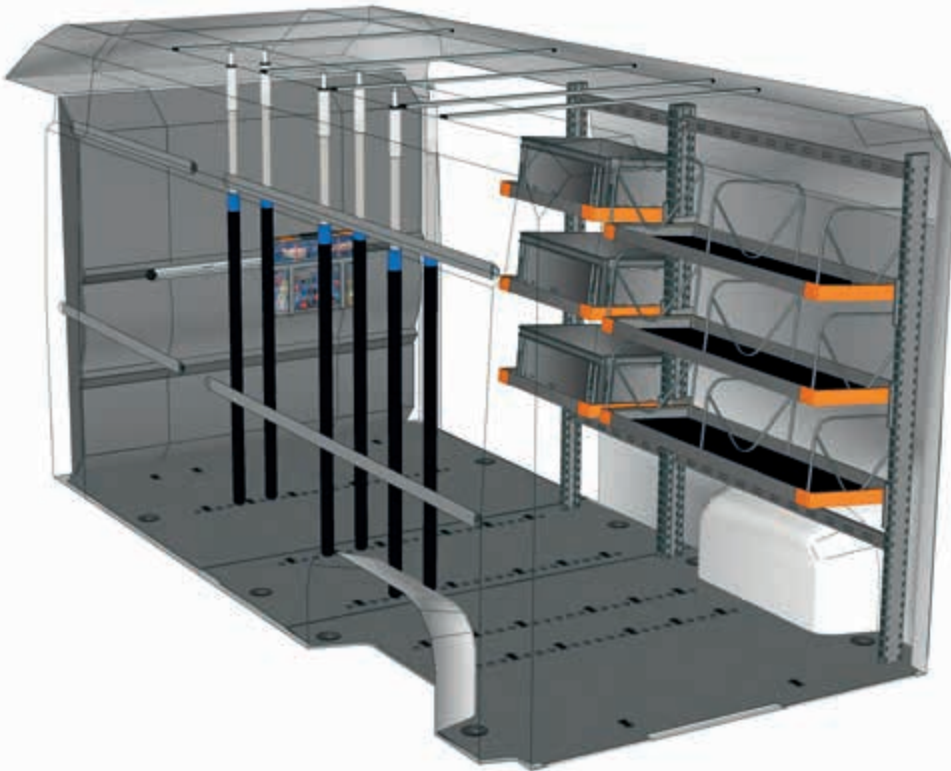

BEISPIEL - EXAMPLE

EXAMPLE DU L4H2 L2 (*) (**)



- | | |
|--------------------------|-------------------------|
| 1 x DU 2018 L2 | 5 x F22 FC V18025 15 00 |
| 9 x F22 LS 445D30 00 99 | 1 x F22 SB BOX080 00 01 |
| 1 x F22 SF DU30G1 A0 1S | 1 x F22 SB CPV080 00 01 |
| 1 x F22 VT V22585 00 08 | 2 x F22 FC V22136 00 00 |
| 6 x F22 FC V22017 00 00 | 2 x F22 FC V22124 00 00 |
| 2 x F22 FC V18029 15 00 | 2 x F22 FC V22148 00 00 |
| 2 x F22 FC V18029 20 00 | 1 x F22 SB YELLOW 63 05 |
| 1 x F22 FC V18029 10 00 | 4 x F22 FC V22582 00 00 |
| 10 x F22 FC V22106 00 00 | |

**Haben Sie Ihre Einrichtung nicht gefunden?
Verlassen Sie sich auf die Profis für
Fahrzeugeinrichtungen.**

Auf der Rückseite dieses Katalogs
finden Sie die nächstgelegene
StoreVan Niederlassung.
Besuchen Sie unsere Web-Seite.

**Didn't find the equipment
you're looking for?
Leave it to our experts.**

See the back of this catalogue
and contact the nearest
StoreVan point or visit our website.



* Einschließlich Befestigungskit - Fixing kit included

** Ohne Behälter - Containers not included

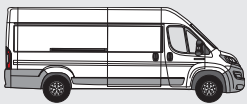

FAHRZEUGEINRICHTUNGSBEISPIELE - FITTINGS EXAMPLES



BEISPIEL - EXAMPLE

DU 3518 L1*

B=3551 T=430 H=1772 mm - W=3551 D=430 H=1772 mm

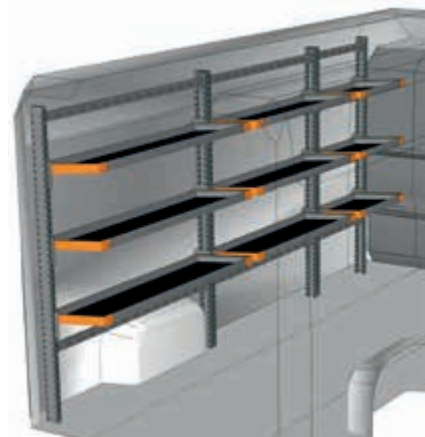
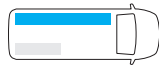

BEISPIEL - EXAMPLE

DU 3518 L2*

B=3551 T=430 H=1772 mm - W=3551 D=430 H=1772 mm

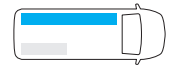

BEISPIEL - EXAMPLE

DU 3518 L3*

B=3551 T=430 H=1772 mm - W=3551 D=430 H=1772 mm

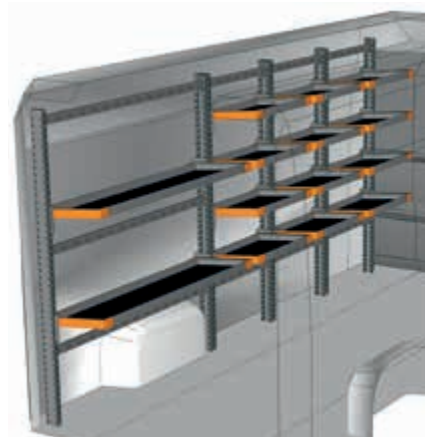
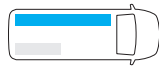

BEISPIEL - EXAMPLE

DU 3518 L4*

B=3675 T=430 H=1772 mm - W=3675 D=430 H=1772 mm

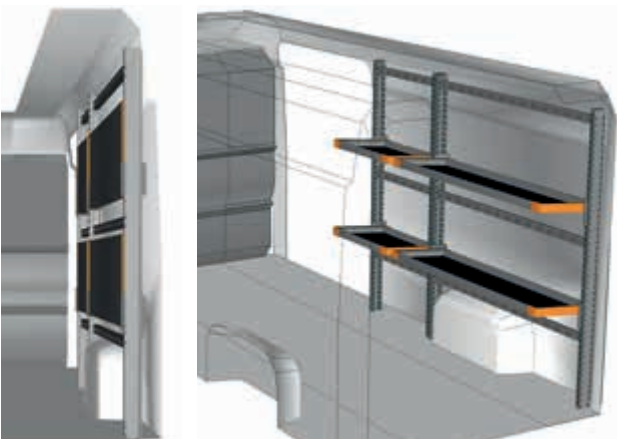
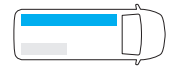

BEISPIEL - EXAMPLE

DU 2218 L1*

B=2241 T=430 H=1772 mm - W=2241 D=430 H=1772 mm

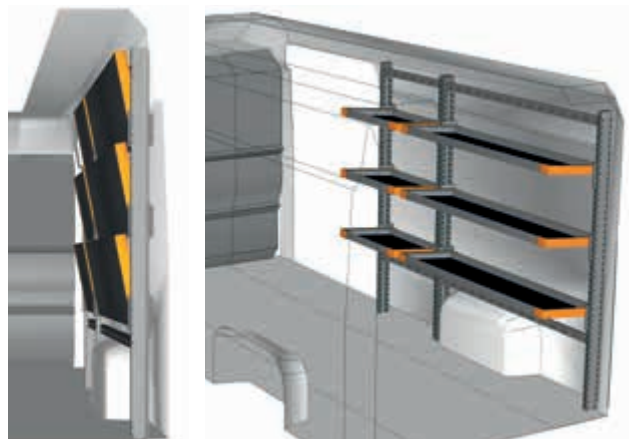
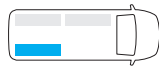

BEISPIEL - EXAMPLE

DU 2218 L2*

B=2241 T=430 H=1772 mm - W=2241 D=430 H=1772 mm

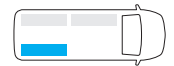

* Einschließlich Befestigungskit - Fixing kit included

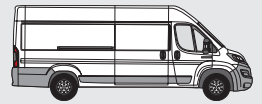

FAHRZEUGEINRICHTUNGSBEISPIELE - FITTINGS EXAMPLES

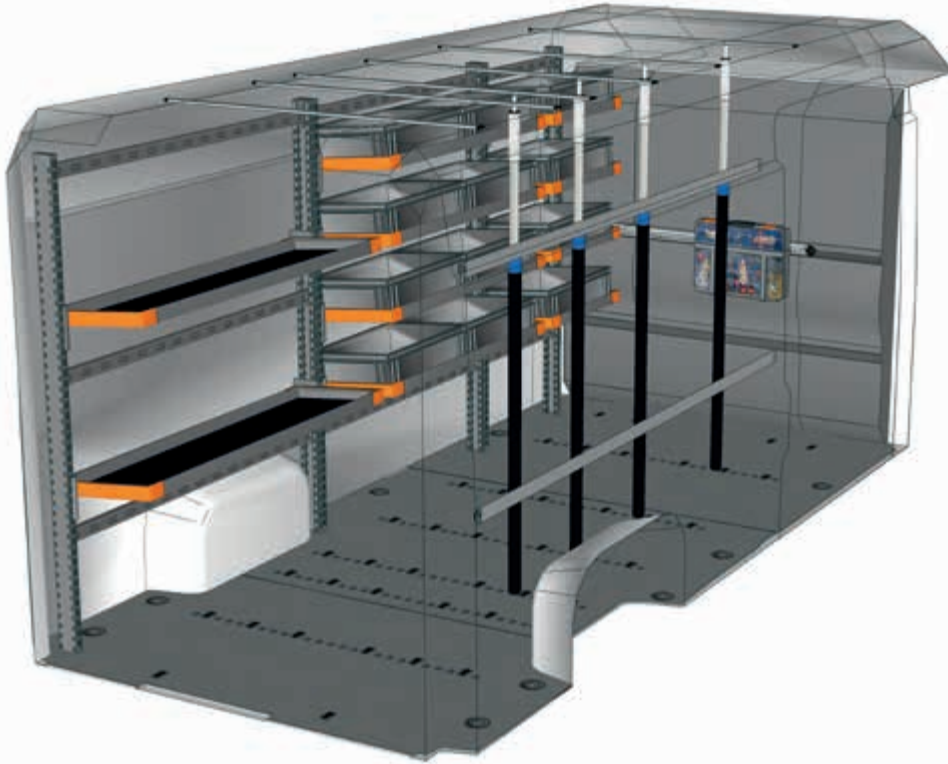

BEISPIEL - EXAMPLE

EXAMPLE DU L5H2 L1 (*) (**)



- | | |
|-------------------------|-------------------------|
| 1 x DU 3518 L4 | 1 x F22 SB CPV080 00 01 |
| 1 x F22 SF DU3LG1 A0 1S | 2 x F22 FC V22136 00 00 |
| 1 x F22 VT V22585 00 08 | 2 x F22 FC V22124 00 00 |
| 4 x F22 FC V22017 00 00 | 2 x F22 FC V22148 00 00 |
| 2 x F22 FC V18029 25 00 | 1 x F22 SB YELLOW 63 05 |
| 1 x F22 FC V18029 10 00 | 4 x F22 FC V22582 00 00 |
| 6 x F22 FC V22106 00 00 | |
| 6 x F22 FC V18025 15 00 | |
| 1 x F22 SB BOX080 00 01 | |

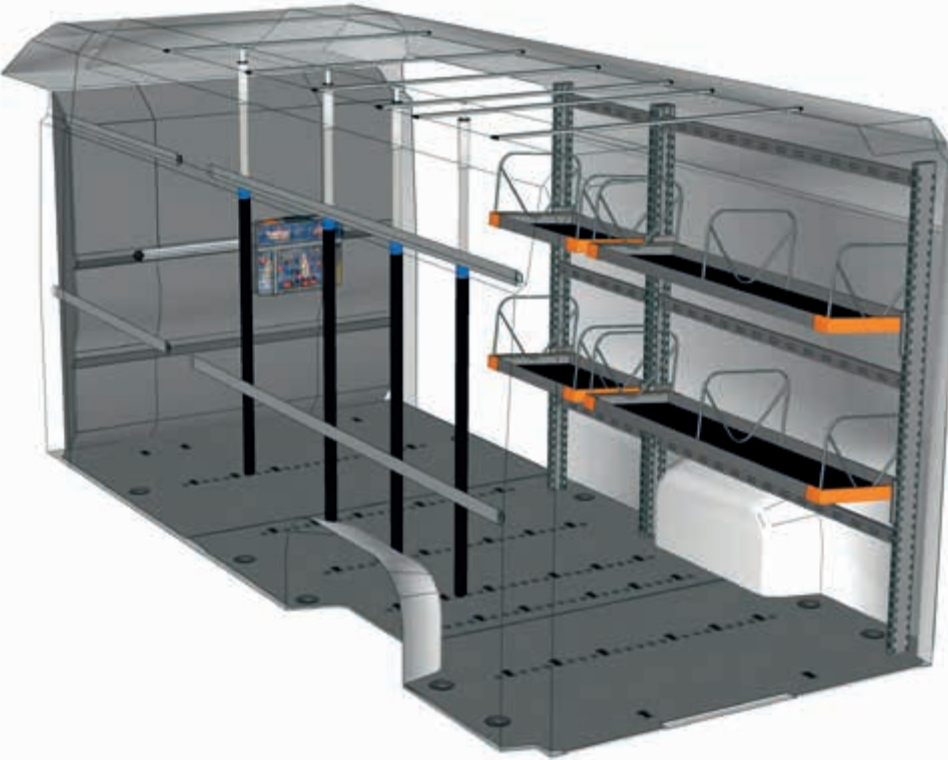

BEISPIEL - EXAMPLE

EXAMPLE DU L5H2 L2*



- | | |
|--------------------------|-------------------------|
| 1 x DU 2218 L2 | 6 x F22 FC V18025 15 00 |
| 10 x F22 LS 445D30 00 99 | 1 x F22 SB BOX080 00 01 |
| 1 x F22 SF DU3LG1 A0 1S | 1 x F22 SB CPV080 00 01 |
| 1 x F22 VT V22585 00 08 | 2 x F22 FC V22136 00 00 |
| 4 x F22 FC V22017 00 00 | 2 x F22 FC V22124 00 00 |
| 2 x F22 FC V18029 15 00 | 2 x F22 FC V22148 00 00 |
| 2 x F22 FC V18029 25 00 | 1 x F22 SB YELLOW 63 05 |
| 1 x F22 FC V18029 10 00 | 4 x F22 FC V22582 00 00 |
| 10 x F22 FC V22106 00 00 | |

**Haben Sie Ihre Einrichtung nicht gefunden?
Verlassen Sie sich auf die Profis für
Fahrzeugeinrichtungen.**

Auf der Rückseite dieses Katalogs
finden Sie die nächstgelegene
StoreVan Niederlassung.
Besuchen Sie unsere Web-Seite.

**Didn't find the equipment
you're looking for?
Leave it to our experts.**

See the back of this catalogue
and contact the nearest
StoreVan point or visit our website.



* Einschließlich Befestigungskit - Fixing kit included

** Ohne Behälter - Containers not included



FAHRZEUGEINRICHTUNGSBEISPIELE - FITTINGS EXAMPLES

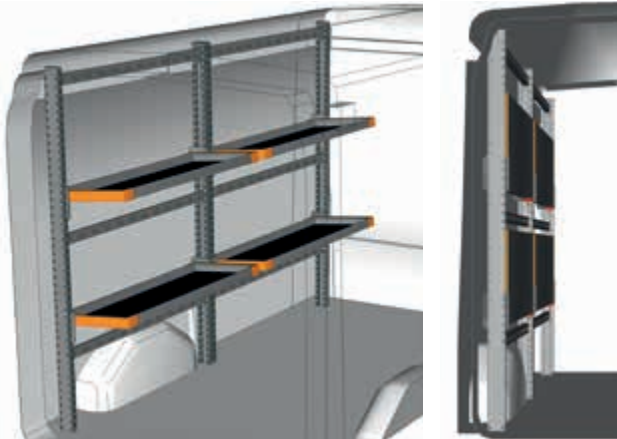

BEISPIEL - EXAMPLE

TR 2518 L1*

B=2535 T=430 H=1772 mm - W=2535 D=430 H=1772 mm

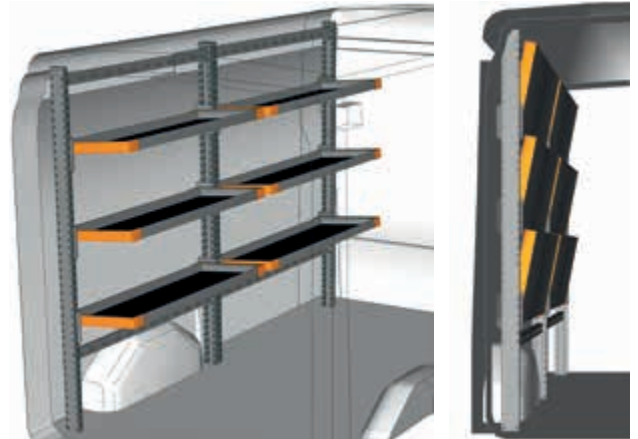
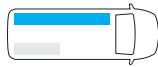

BEISPIEL - EXAMPLE

TR 2518 L2*

B=2535 T=430 H=1772 mm - W=2535 D=430 H=1772 mm

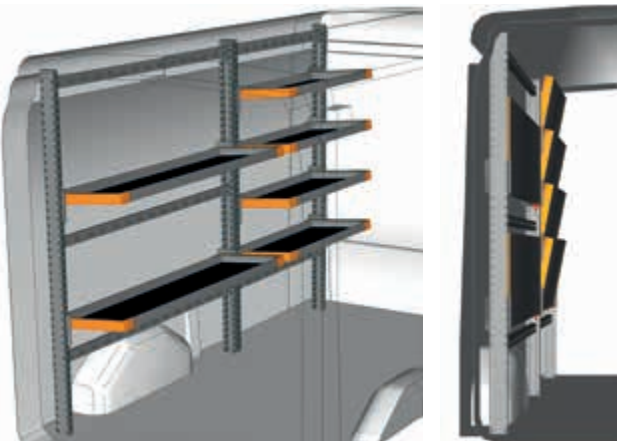
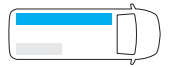

BEISPIEL - EXAMPLE

TR 2518 L3*

B=2540 T=430 H=1772 mm - W=2540 D=430 H=1772 mm

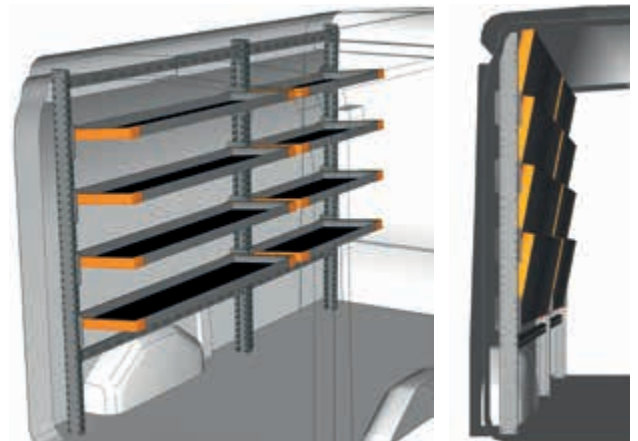
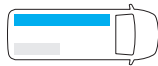

BEISPIEL - EXAMPLE

TR 2518 L4*

B=2540 T=430 H=1772 mm - W=2540 D=430 H=1772 mm

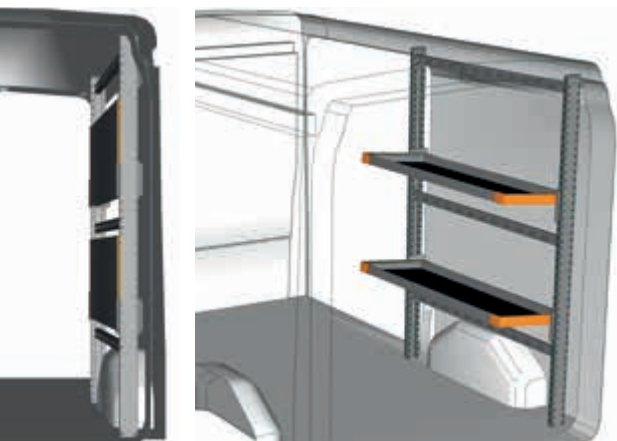

BEISPIEL - EXAMPLE

TR 1318 L1*

B=1310 T=430 H=1772 mm - W=1310 D=430 H=1772 mm

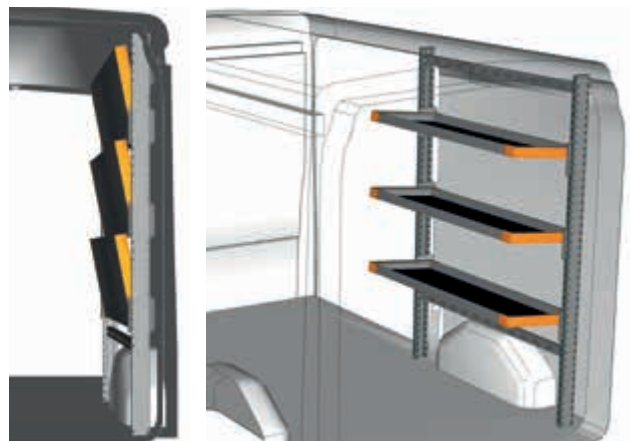
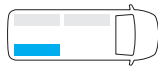

BEISPIEL - EXAMPLE

TR 1318 L2*

B=1310 T=430 H=1772 mm - W=1310 D=430 H=1772 mm



* Einschließlich Befestigungskit - Fixing kit included



FAHRZEUGEINRICHTUNGSBEISPIELE - FITTINGS EXAMPLES

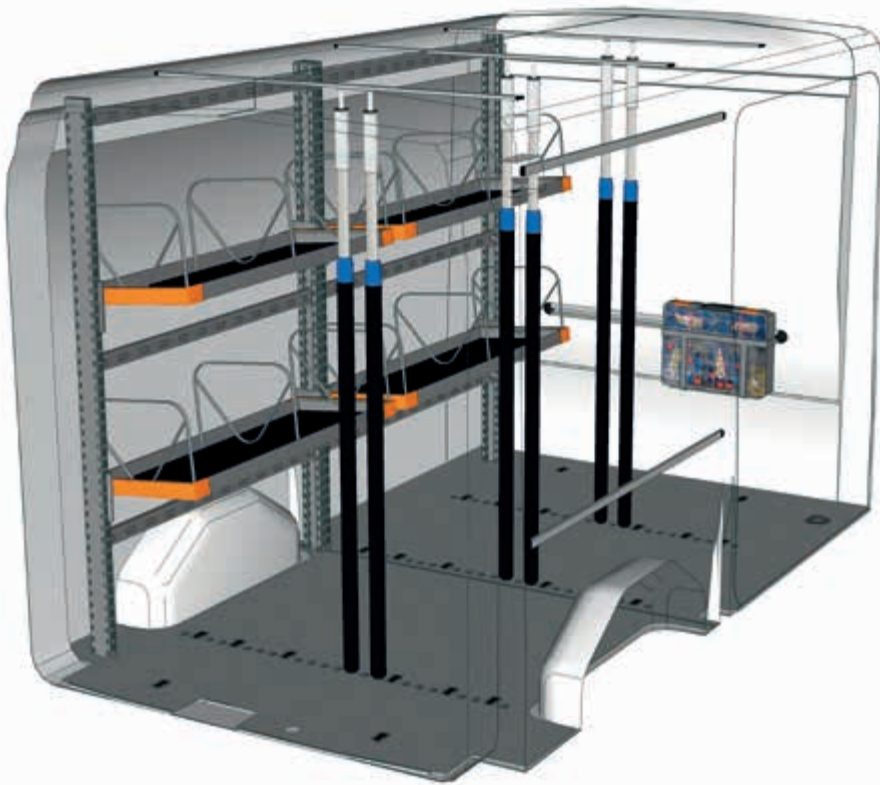

BEISPIEL - EXAMPLE

EXAMPLE TR L2H2 L1*



- | | |
|--------------------------|-------------------------|
| 1 x TR 2518 L1 | 1 x F22 SB CPV080 00 01 |
| 12 x F22 LS 445D30 00 99 | 2 x F22 FC V22136 00 00 |
| 1 x F22 SF TR20G1 A0 1S | 2 x F22 FC V22124 00 00 |
| 1 x F22 VT V22585 00 08 | 2 x F22 FC V22148 00 00 |
| 6 x F22 FC V22017 00 00 | 1 x F22 SB YELLOW 63 05 |
| 1 x F22 FC V18029 10 00 | 4 x F22 FC V22582 00 00 |
| 2 x F22 FC V22106 00 00 | |
| 5 x F22 FC V18025 15 00 | |
| 1 x F22 SB BOX080 00 01 | |

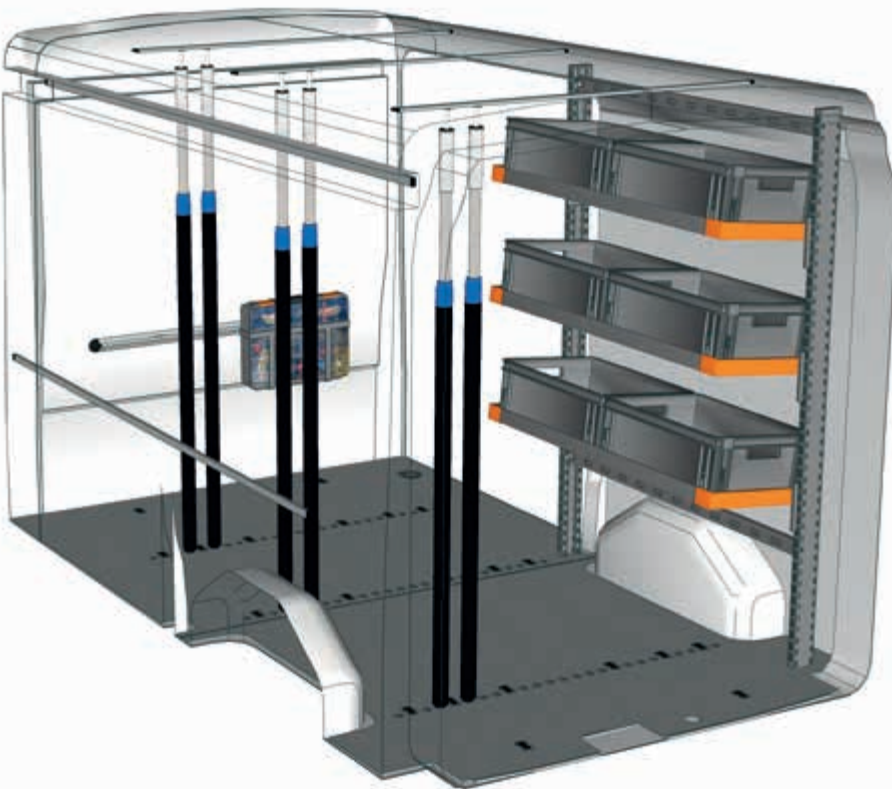

BEISPIEL - EXAMPLE

EXAMPLE TR L2H2 L2(*)**



- | | |
|-------------------------|-------------------------|
| 1 x TR 1318 L2 | 1 x F22 SB CPV080 00 01 |
| 1 x F22 SF TR20G1 A0 1S | 2 x F22 FC V22136 00 00 |
| 1 x F22 VT V22585 00 08 | 2 x F22 FC V22124 00 00 |
| 6 x F22 FC V22017 00 00 | 2 x F22 FC V22148 00 00 |
| 1 x F22 FC V18029 10 00 | 1 x F22 SB YELLOW 63 05 |
| 2 x F22 FC V22106 00 00 | 4 x F22 FC V22582 00 00 |
| 2 x F22 FC V18025 25 00 | |
| 3 x F22 FC V18025 15 00 | |
| 1 x F22 SB BOX080 00 01 | |



* Einschließlich Befestigungskit - Fixing kit included

** Ohne Behälter - Containers not included

Haben Sie Ihre Einrichtung nicht gefunden?
Verlassen Sie sich auf die Profis für Fahrzeugeinrichtungen.
 Auf der Rückseite dieses Katalogs finden Sie die nächstgelegene StoreVan Niederlassung. Besuchen Sie unsere Web-Seite.

Didn't find the equipment you're looking for?
Leave it to our experts.
 See the back of this catalogue and contact the nearest StoreVan point or visit our website.



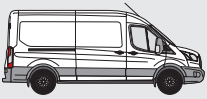

FAHRZEUGEINRICHTUNGSBEISPIELE - FITTINGS EXAMPLES

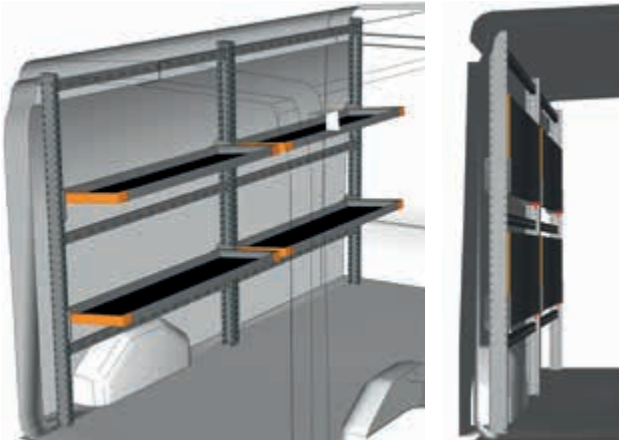

BEISPIEL - EXAMPLE

TR 3018 L1*

B=3048 T=430 H=1772 mm - W=3048 D=430 H=1772 mm

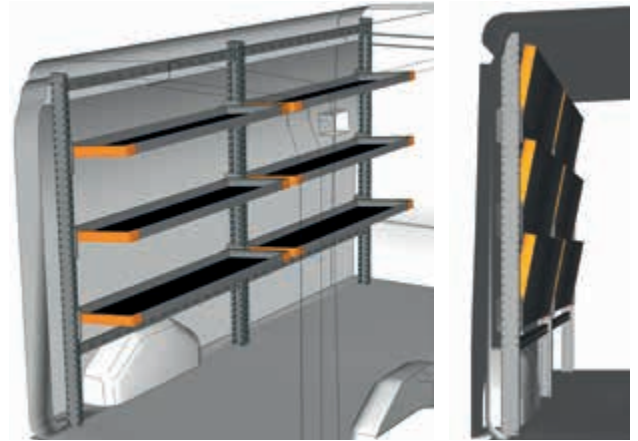
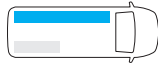

BEISPIEL - EXAMPLE

TR 3018 L2*

B=3048 T=430 H=1772 mm - W=3048 D=430 H=1772 mm

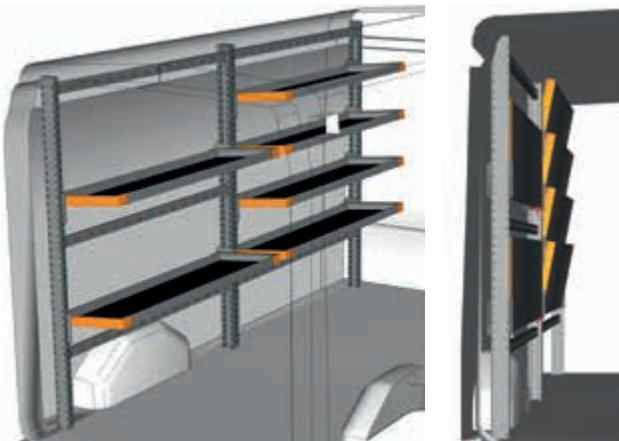

BEISPIEL - EXAMPLE

TR 3018 L3*

B=3048 T=430 H=1772 mm - W=3048 D=430 H=1772 mm

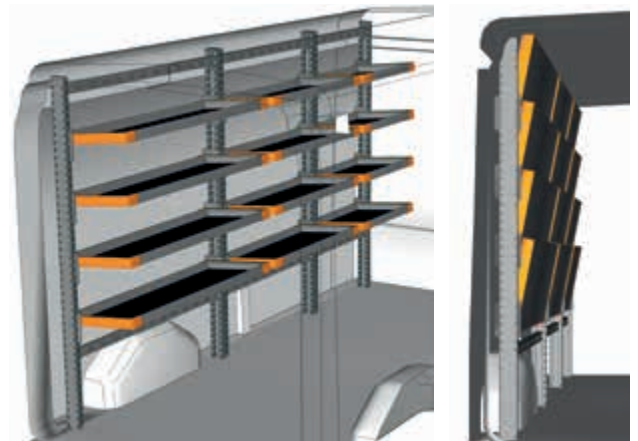
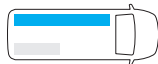

BEISPIEL - EXAMPLE

TR 3018 L4*

B=3043 T=430 H=1772 mm - W=3043 D=430 H=1772 mm

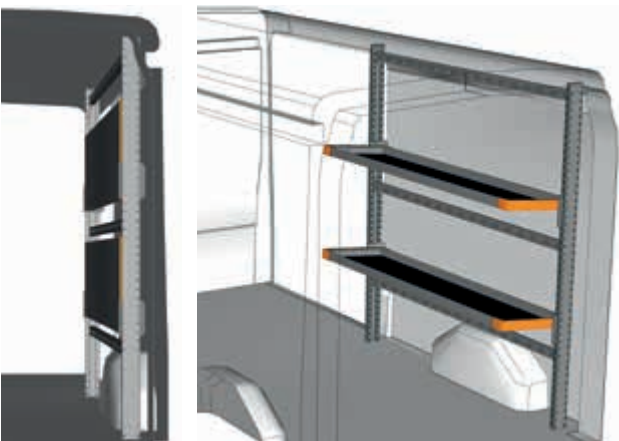

BEISPIEL - EXAMPLE

TR 1718 L1*

B=1733 T=430 H=1772 mm - W=1733 D=430 H=1772 mm

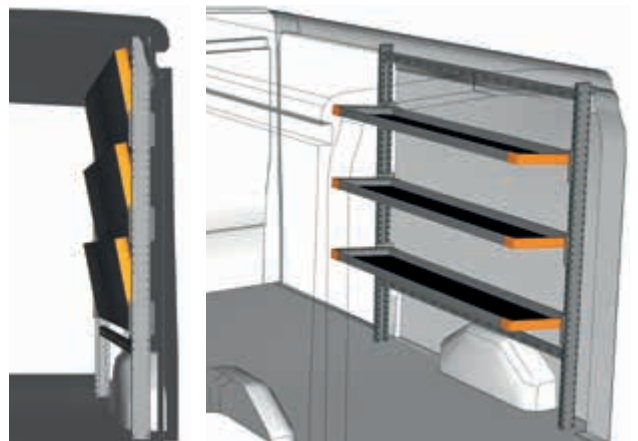

BEISPIEL - EXAMPLE

TR 1718 L2*

B=1733 T=430 H=1772 mm - W=1733 D=430 H=1772 mm



* Einschließlich Befestigungskit - Fixing kit included

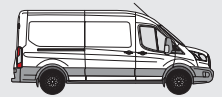

FAHRZEUGEINRICHTUNGSBEISPIELE - FITTINGS EXAMPLES

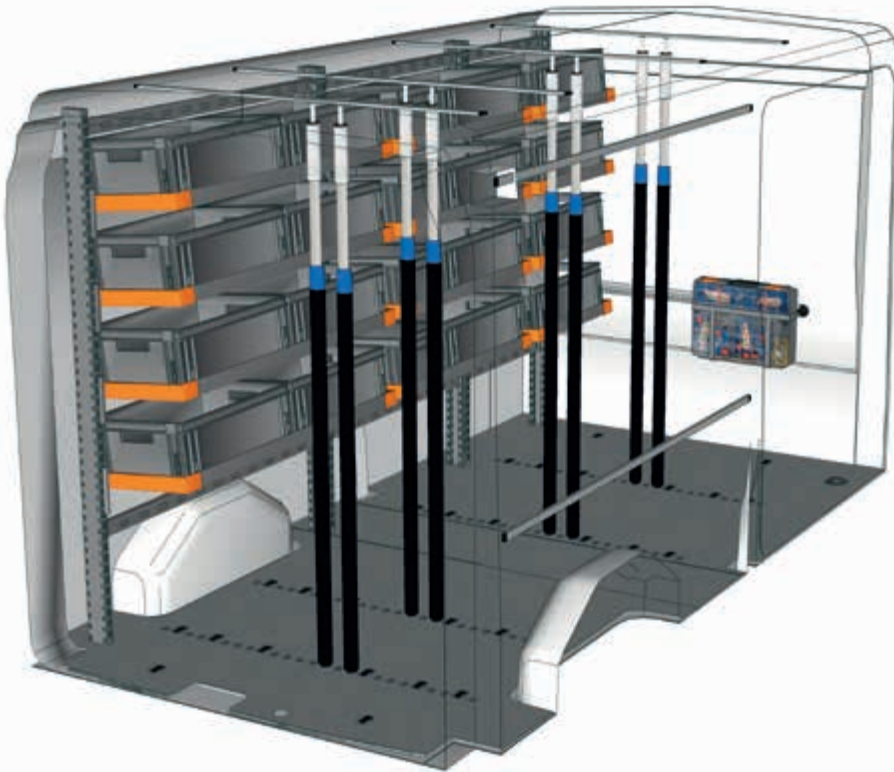

BEISPIEL - EXAMPLE

EXAMPLE TR L3H2 L1 (*) (**)



- | | |
|-------------------------|-------------------------|
| 1 x TR 3018 L4 | 1 x F22 SB CPV080 00 01 |
| 1 x F22 SF TR30G1 A0 1S | 2 x F22 FC V22136 00 00 |
| 1 x F22 VT V22585 00 08 | 2 x F22 FC V22124 00 00 |
| 8 x F22 FC V22017 00 00 | 2 x F22 FC V22148 00 00 |
| 1 x F22 FC V18029 10 00 | 1 x F22 SB YELLOW 63 05 |
| 2 x F22 FC V22106 00 00 | 4 x F22 FC V22582 00 00 |
| 4 x F22 FC V18025 15 00 | |
| 2 x F22 FC V18025 20 00 | |
| 1 x F22 SB BOX080 00 01 | |

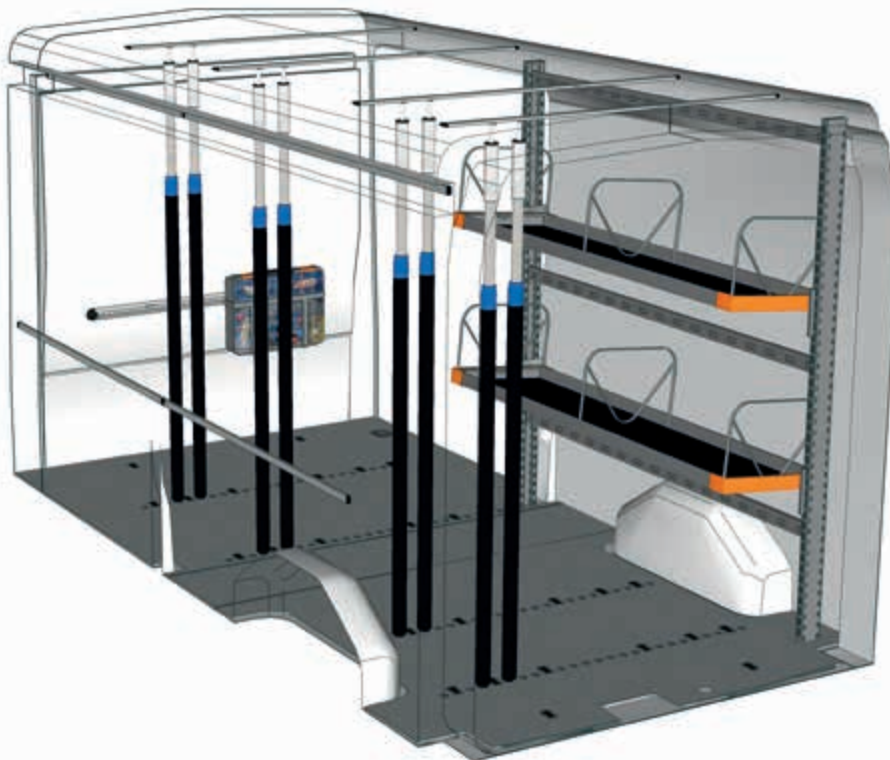

BEISPIEL - EXAMPLE

EXAMPLE TR L3H2 L2*



- | | |
|-------------------------|-------------------------|
| 1 x TR 1718 L1 | 1 x F22 SB BOX080 00 01 |
| 6 x F22 LS 445D30 00 99 | 1 x F22 SB CPV080 00 01 |
| 1 x F22 SF TR30G1 A0 1S | 2 x F22 FC V22136 00 00 |
| 1 x F22 VT V22585 00 08 | 2 x F22 FC V22124 00 00 |
| 8 x F22 FC V22017 00 00 | 2 x F22 FC V22148 00 00 |
| 1 x F22 FC V18029 10 00 | 1 x F22 SB YELLOW 63 05 |
| 2 x F22 FC V22106 00 00 | 4 x F22 FC V22582 00 00 |
| 7 x F22 FC V18025 15 00 | |
| 1 x F22 FC V18025 20 00 | |



* Einschließlich Befestigungskit - Fixing kit included

** Ohne Behälter - Containers not included

Haben Sie Ihre Einrichtung nicht gefunden?
Verlassen Sie sich auf die Profis für Fahrzeugeinrichtungen.
 Auf der Rückseite dieses Katalogs finden Sie die nächstgelegene StoreVan Niederlassung. Besuchen Sie unsere Web-Seite.

Didn't find the equipment you're looking for?
Leave it to our experts.
 See the back of this catalogue and contact the nearest StoreVan point or visit our website.





FAHRZEUGEINRICHTUNGSBEISPIELE - FITTINGS EXAMPLES



BEISPIEL - EXAMPLE

DA 2618 L1*

B=2620 T=430 H=1772 mm - W=2620 D=430 H=1772 mm

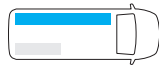

BEISPIEL - EXAMPLE

DA 2618 L2*

B=2620 T=430 H=1772 mm - W=2620 D=430 H=1772 mm

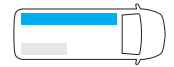

BEISPIEL - EXAMPLE

DA 2618 L3*

B=2620 T=430 H=1772 mm - W=2620 D=430 H=1772 mm

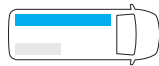

BEISPIEL - EXAMPLE

DA 2618 L4*

B=2744 T=430 H=1772 mm - W=2744 D=430 H=1772 mm

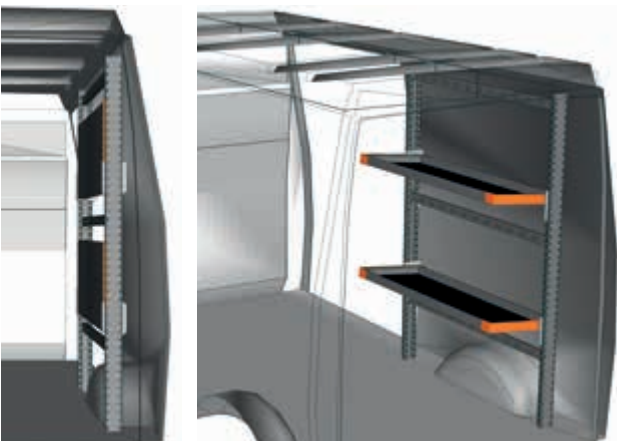
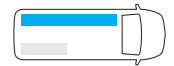

BEISPIEL - EXAMPLE

DA 1318 L1*

B=1310 T=430 H=1772 mm - W=1310 D=430 H=1772 mm

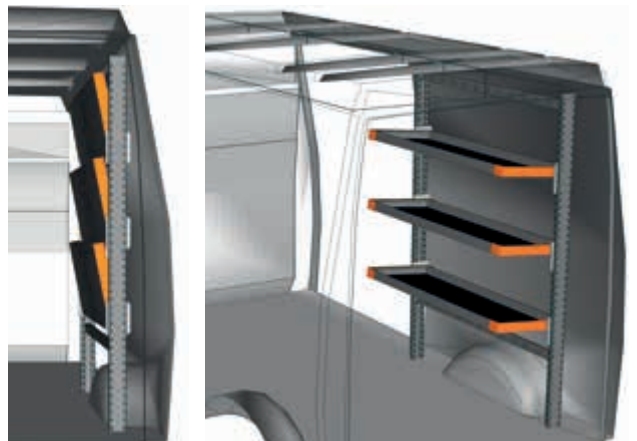
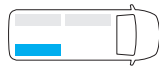

BEISPIEL - EXAMPLE

DA 1318 L2*

B=1310 T=430 H=1772 mm - W=1310 D=430 H=1772 mm



* Einschließlich Befestigungskit - Fixing kit included

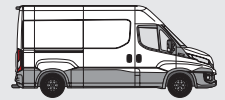

FAHRZEUGEINRICHTUNGSBEISPIELE - FITTINGS EXAMPLES



BEISPIEL - EXAMPLE

EXAMPLE DA L2H2 L1 (*) (**)



- | | |
|-------------------------|-------------------------|
| 1 x DA 2618 L4 | 2 x F22 FC V22136 00 00 |
| 1 x F22 SF DA20G1 J0 1S | 2 x F22 FC V22124 00 00 |
| 4 x F22 FC V18025 15 00 | 4 x F22 FC V22582 00 00 |
| 8 x F22 FC V23389 00 00 | 1 x F22 SB YELLOW 63 05 |
| 6 x F22 FC V22017 00 00 | 1 x F22 SB CPV08 00 001 |
| 2 x F22 FC V1802915 00 | 1 x F22 SB BOX08 00 001 |
| 6 x F22 FC V22106 00 00 | |
| 1 x F22 FC V180291 000 | |
| 2 x F22 FC V22148 00 00 | |

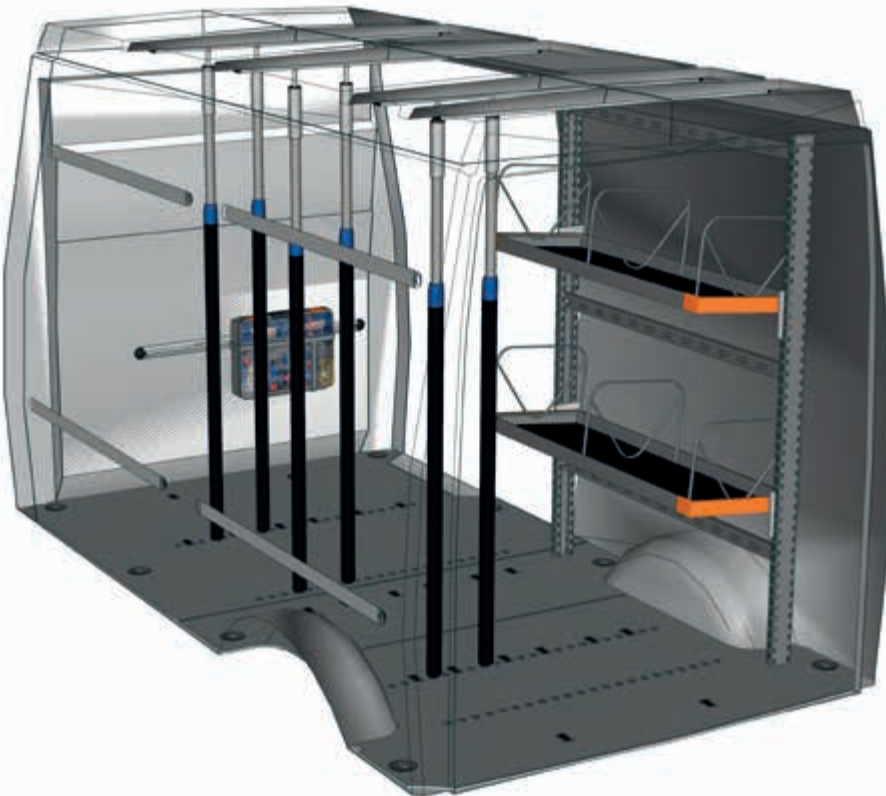

BEISPIEL - EXAMPLE

EXAMPLE DA L2H2 L2*



- | | |
|--------------------------|--------------------------|
| 1 x DA 1318 L1 | 1 x F22 SB YELLOW 63 05 |
| 1 x F22 SF DA20G1 J0 1S | 1 x F22 SB CPV08 00 00 1 |
| 5 x F22 FC V1802915 00 | 1 x F22 SB BOX08 00 00 1 |
| 10 x F22 FC V22106 00 00 | |
| 6 x F22 FC V22017 00 00 | |
| 2 x F22 FC V22148 00 00 | |
| 2 x F22 FC V22136 00 00 | |
| 2 x F22 FC V22124 00 00 | |
| 4 x F22 FC V22582 00 00 | |



* Einschließlich Befestigungskit - Fixing kit included

** Ohne Behälter - Containers not included

Haben Sie Ihre Einrichtung nicht gefunden?
Verlassen Sie sich auf die Profis für Fahrzeugeinrichtungen.
 Auf der Rückseite dieses Katalogs finden Sie die nächstgelegene StoreVan Niederlassung. Besuchen Sie unsere Web-Seite.

Didn't find the equipment you're looking for?
Leave it to our experts.
 See the back of this catalogue and contact the nearest StoreVan point or visit our website.



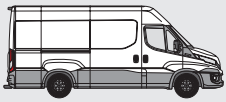

FAHRZEUGEINRICHTUNGSBEISPIELE - FITTINGS EXAMPLES



BEISPIEL - EXAMPLE

DA 3018 L1*

B=3043 T=430 H=1772 mm - W=3043 D=430 H=1772 mm

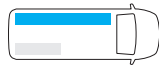

BEISPIEL - EXAMPLE

DA 3018 L2*

B=3043 T=430 H=1772 mm - W=3043 D=430 H=1772 mm

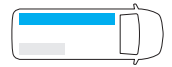

BEISPIEL - EXAMPLE

DA 3218 L3*

B=3257 T=430 H=1772 mm - W=3257 D=430 H=1772 mm

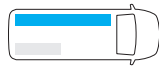

BEISPIEL - EXAMPLE

DA 3218 L4*

B=3167 T=430 H=1772 mm - W=3167 D=430 H=1772 mm

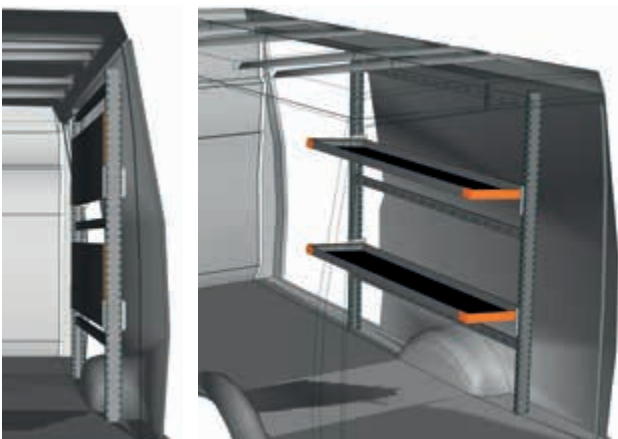
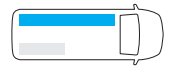

BEISPIEL - EXAMPLE

DA 1718 L1*

B=1733 T=430 H=1772 mm - W=1733 D=430 H=1772 mm

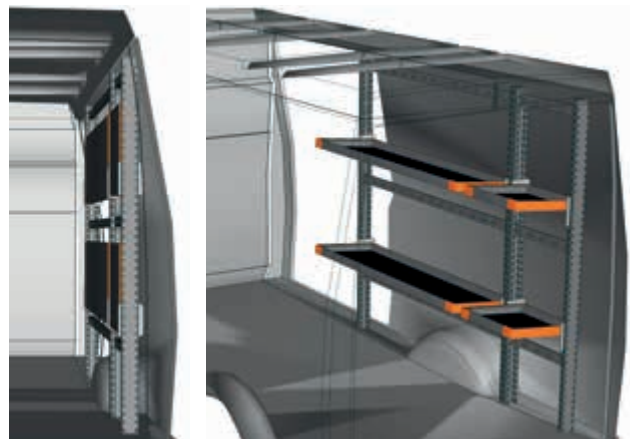
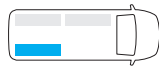

BEISPIEL - EXAMPLE

DA 2018 L2*

B=2032 T=430 H=1772 mm - W=2032 D=430 H=1772 mm

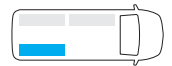

* Einschließlich Befestigungskit - Fixing kit included

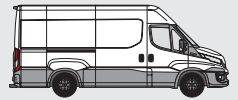

FAHRZEUGEINRICHTUNGSBEISPIELE - FITTINGS EXAMPLES

KASTENWAGEN - PANEL VAN
LIGHT SHELF



BEISPIEL - EXAMPLE

EXAMPLE DA L2LH2 L1(*)(**)



- | | |
|-------------------------|-------------------------|
| 1 x DA 3218 L4 | 2 x F22 FC V22136 00 00 |
| 1 x F22 SF DA2LG1 J0 1S | 2 x F22 FC V22124 00 00 |
| 4 x F22 FC V18025 15 00 | 4 x F22 FC V22582 00 00 |
| 8 x F22 FC V23389 00 00 | 1 x F22 SB YELLOW 63 05 |
| 2 x F22 FC V180292 000 | 1 x F22 SB CPV08 00 001 |
| 6 x F22 FC V22106 00 00 | 1 x F22 SB BOX08 00 001 |
| 6 x F22 FC V22017 00 00 | |
| 1 x F22 FC V18029 15 00 | |
| 2 x F22 FC V22148 00 00 | |

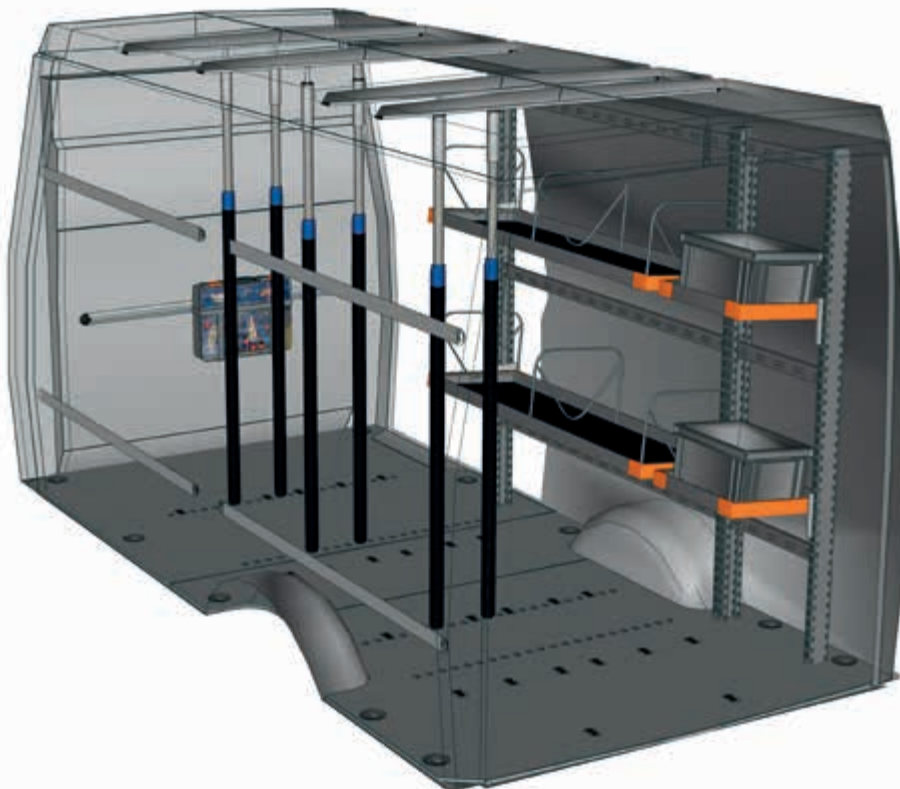

BEISPIEL - EXAMPLE

EXAMPLE DA L2LH2 L2(*)(**)



- | | |
|-------------------------|-------------------------|
| 1 x DA 2018 L2 | 2 x F22 FC V22124 00 00 |
| 1 x F22 SF DA2LG1 J0 1S | 4 x F22 FC V22582 00 00 |
| 4 x F22 FC V18025 15 00 | 1 x F22 SB YELLOW 63 05 |
| 8 x F22 FC V23389 00 00 | 1 x F22 SB CPV08 00 001 |
| 3 x F22 FC V18029 20 00 | 1 x F22 SB BOX08 00 001 |
| 6 x F22 FC V22106 00 00 | |
| 6 x F22 FC V22017 00 00 | |
| 2 x F22 FC V22148 00 00 | |
| 2 x F22 FC V22136 00 00 | |

**Haben Sie Ihre Einrichtung nicht gefunden?
Verlassen Sie sich auf die Profis für
Fahrzeugeinrichtungen.**

Auf der Rückseite dieses Katalogs
finden Sie die nächstgelegene
StoreVan Niederlassung.
Besuchen Sie unsere Web-Seite.

**Didn't find the equipment
you're looking for?
Leave it to our experts.**

See the back of this catalogue
and contact the nearest
StoreVan point or visit our website.



* Einschließlich Befestigungskit - Fixing kit included

** Ohne Behälter - Containers not included

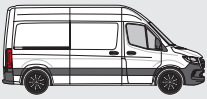

FAHRZEUGEINRICHTUNGSBEISPIELE - FITTINGS EXAMPLES



BEISPIEL - EXAMPLE

SP 2818 L1*

B=2834 T=430 H=1772 mm - W=2834 D=430 H=1772 mm

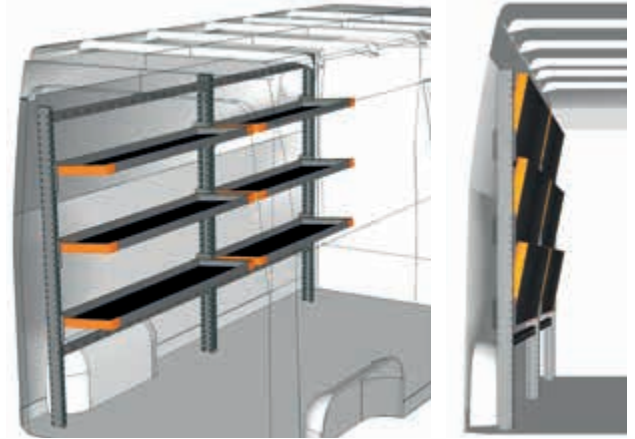
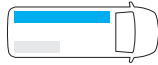

BEISPIEL - EXAMPLE

SP 2818 L2*

B=2834 T=430 H=1772 mm - W=2834 D=430 H=1772 mm

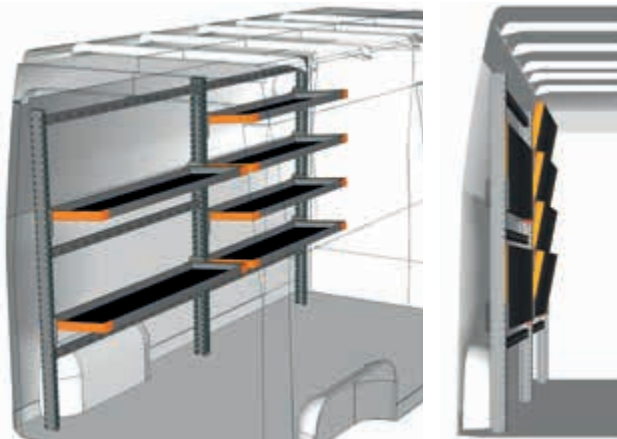
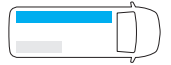

BEISPIEL - EXAMPLE

SP 2818 L3*

B=2834 T=430 H=1772 mm - W=2834 D=430 H=1772 mm

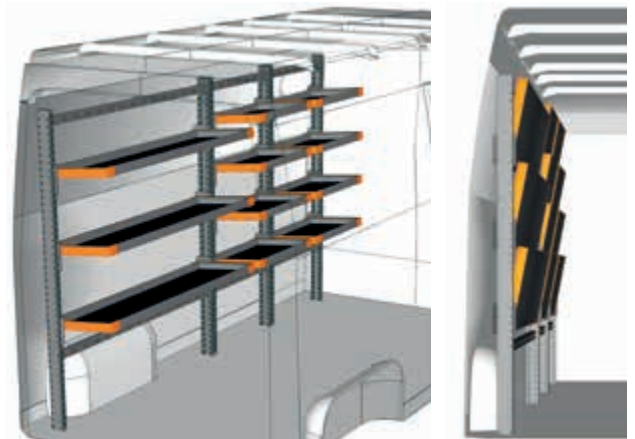
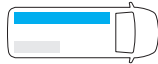

BEISPIEL - EXAMPLE

SP 2918 L1*

B=2958 T=430 H=1772 mm - W=2958 D=430 H=1772 mm

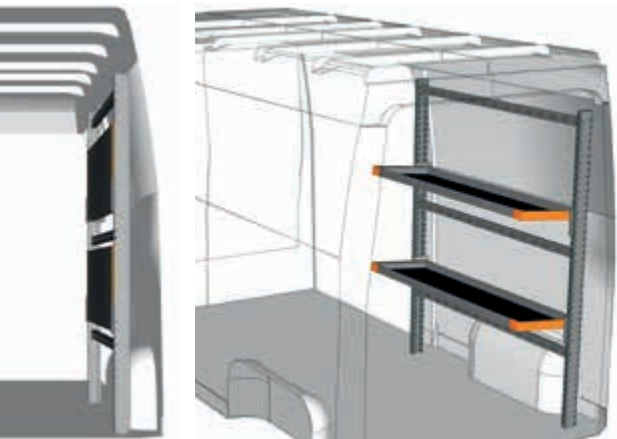
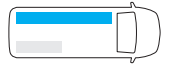

BEISPIEL - EXAMPLE

SP 1518 L1*

B=1524 T=430 H=1772 mm - W=1524 D=430 H=1772 mm

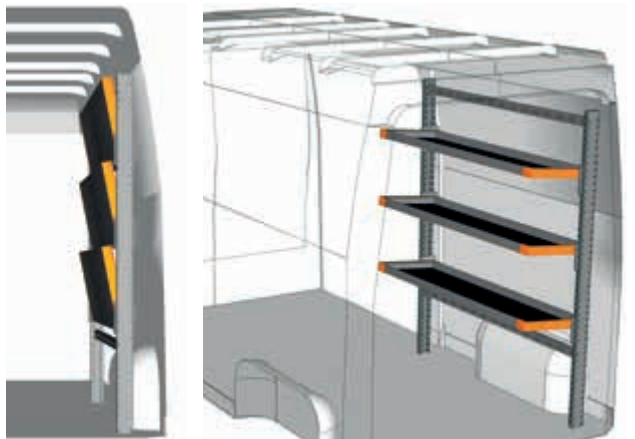
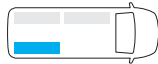

BEISPIEL - EXAMPLE

SP 1518 L2*

B=1524 T=430 H=1772 mm - W=1524 D=430 H=1772 mm



* Einschließlich Befestigungskit - Fixing kit included

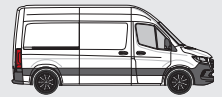

FAHRZEUGEINRICHTUNGSBEISPIELE - FITTINGS EXAMPLES

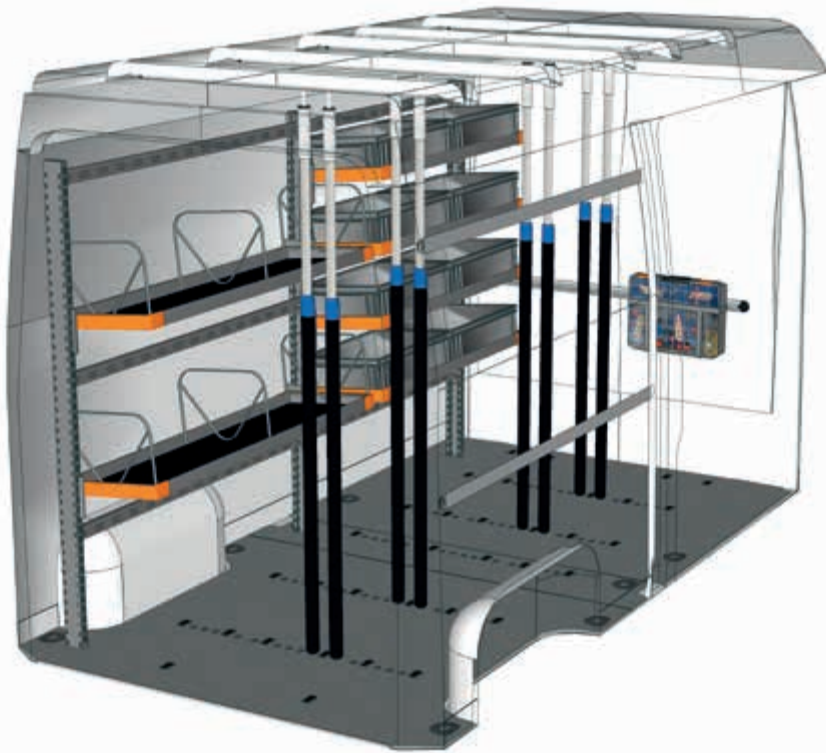

BEISPIEL - EXAMPLE

EXAMPLE SP L2H2 L1 FWD(*)(**)



1 x SP 2818 L3	10 x F22 FC V23389 00 00
6 x F22 LS 445D30 00 99	1 x F22 SB BOX080 00 01
1 x F22 SF SP20G1 A1 1S	1 x F22 SB CPV080 00 01
1 x F22 VT V22585 00 08	2 x F22 FC V22136 00 00
8 x F22 FC V22017 00 00	2 x F22 FC V22124 00 00
1 x F22 FC V18029 15 00	2 x F22 FC V22148 00 00
2 x F22 FC V18029 20 00	1 x F22 SB YELLOW 63 05
6 x F22 FC V22106 00 00	4 x F22 FC V22090 00 00
5 x F22 FC V18025 15 00	

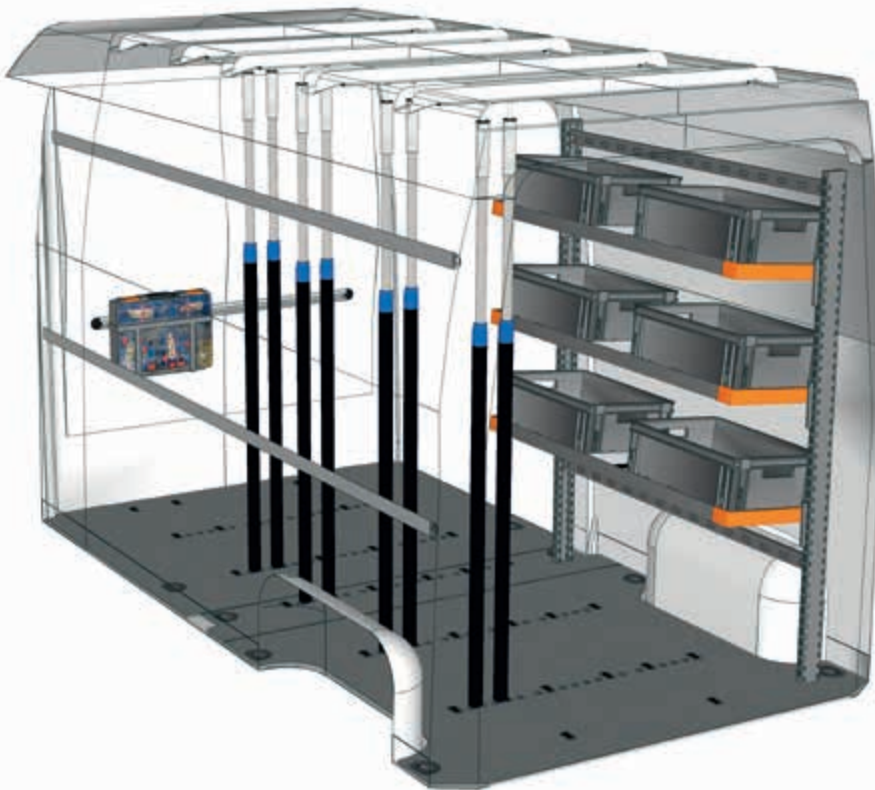

BEISPIEL - EXAMPLE

EXAMPLE SP L2H2 L2 FWD(*)(**)



1 x SP 1518 L2	10 x F22 FC V23389 00 00
6 x F22 LS 445D30 00 99	1 x F22 SB BOX080 00 01
1 x F22 SF SP20G1 A1 1S	1 x F22 SB CPV080 00 01
1 x F22 VT V22585 00 08	2 x F22 FC V22136 00 00
8 x F22 FC V22017 00 00	2 x F22 FC V22124 00 00
1 x F22 FC V18029 15 00	2 x F22 FC V22148 00 00
2 x F22 FC V18029 35 00	1 x F22 SB YELLOW 63 05
4 x F22 FC V22106 00 00	4 x F22 FC V22090 00 00
5 x F22 FC V18025 15 00	

**Haben Sie Ihre Einrichtung nicht gefunden?
Verlassen Sie sich auf die Profis für
Fahrzeugeinrichtungen.**

Auf der Rückseite dieses Katalogs
finden Sie die nächstgelegene
StoreVan Niederlassung.
Besuchen Sie unsere Web-Seite.

**Didn't find the equipment
you're looking for?
Leave it to our experts.**

See the back of this catalogue
and contact the nearest
StoreVan point or visit our website.



* Einschließlich Befestigungskit - Fixing kit included

** Ohne Behälter - Containers not included

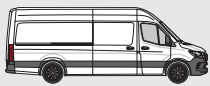

FAHRZEUGEINRICHTUNGSBEISPIELE - FITTINGS EXAMPLES

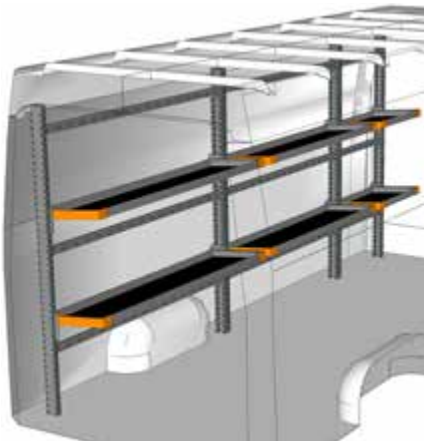

BEISPIEL - EXAMPLE

SP 3918 L1*

B=3974 T=430 H=1772 mm - W=3974 D=430 H=1772 mm

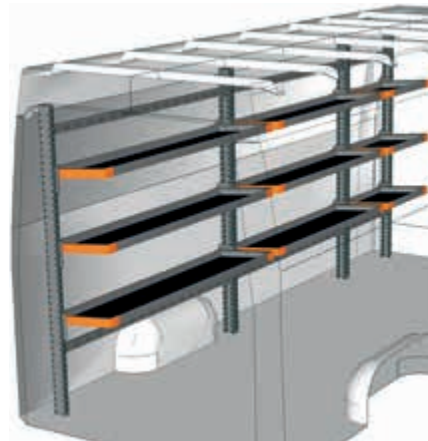
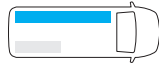

BEISPIEL - EXAMPLE

SP 3918 L2*

B=3974 T=430 H=1772 mm - W=3974 D=430 H=1772 mm

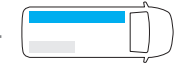

BEISPIEL - EXAMPLE

SP 3918 L3*

B=3974 T=430 H=1772 mm - W=3974 D=430 H=1772 mm

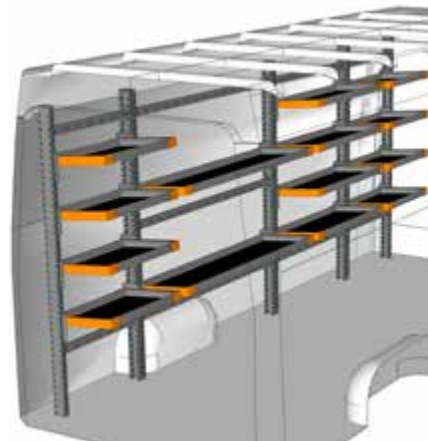
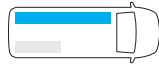

BEISPIEL - EXAMPLE

SP 3918 L4*

B=3974 T=430 H=1772 mm - W=3974 D=430 H=1772 mm

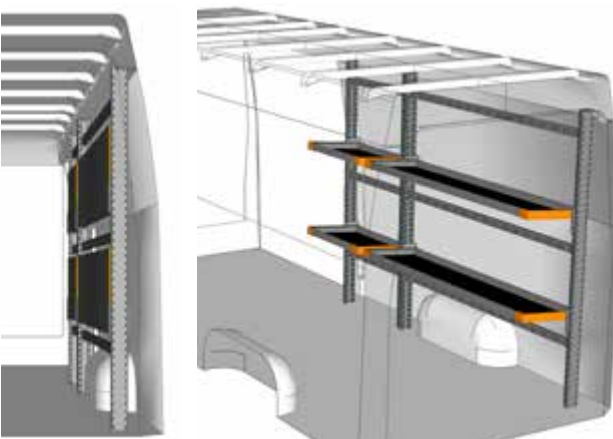
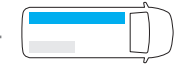

BEISPIEL - EXAMPLE

SP 2418 L1*

B=2450 T=430 H=1772 mm - W=2450 D=430 H=1772 mm

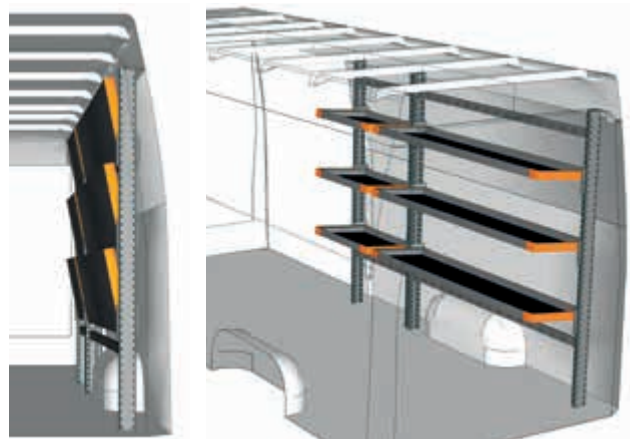
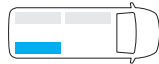

BEISPIEL - EXAMPLE

SP 2418 L2*

B=2450 T=430 H=1772 mm - W=2450 D=430 H=1772 mm

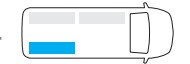

* Einschließlich Befestigungskit - Fixing kit included

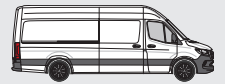

FAHRZEUGEINRICHTUNGSBEISPIELE - FITTINGS EXAMPLES

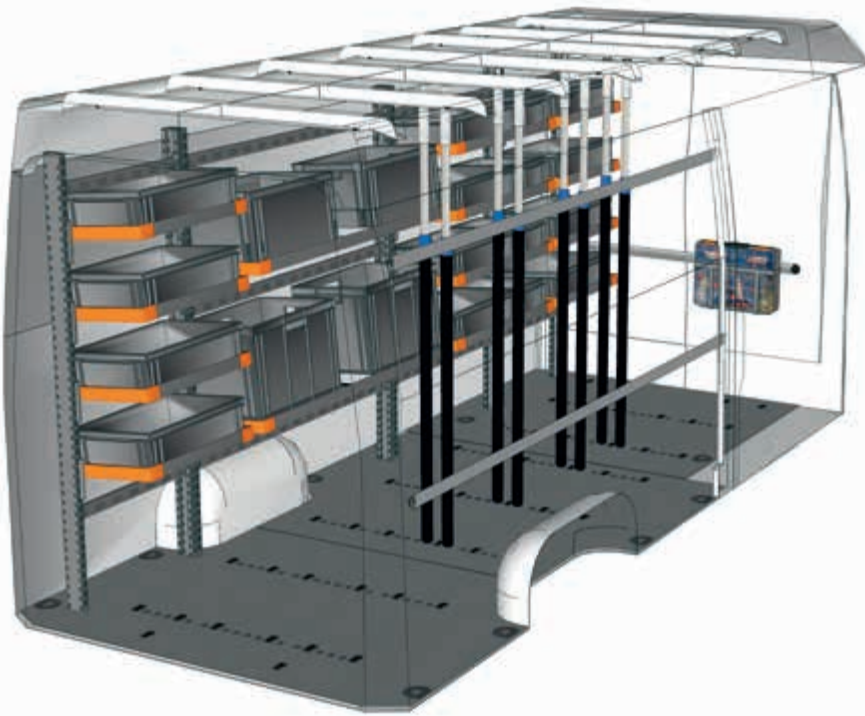

BEISPIEL - EXAMPLE

EXAMPLE SP L3H2 L1 RWD(*) (**)



- | | |
|-------------------------|--------------------------|
| 1 x SP 3918 L4 | |
| 4 x F22 LS 445D05 00 00 | 14 x F22 FC V23389 00 00 |
| 1 x F22 SF SP30G1 J1 1S | 1 x F22 SB BOX080 00 01 |
| 1 x F22 VT V22585 00 08 | 1 x F22 SB CPV080 00 01 |
| 8 x F22 FC V22017 00 00 | 2 x F22 FC V22136 00 00 |
| 1 x F22 FC V18029 15 00 | 2 x F22 FC V22124 00 00 |
| 2 x F22 FC V18029 30 00 | 2 x F22 FC V22148 00 00 |
| 6 x F22 FC V22106 00 00 | 1 x F22 SB YELLOW 63 05 |
| 7 x F22 FC V18025 15 00 | 4 x F22 FC V22090 00 00 |

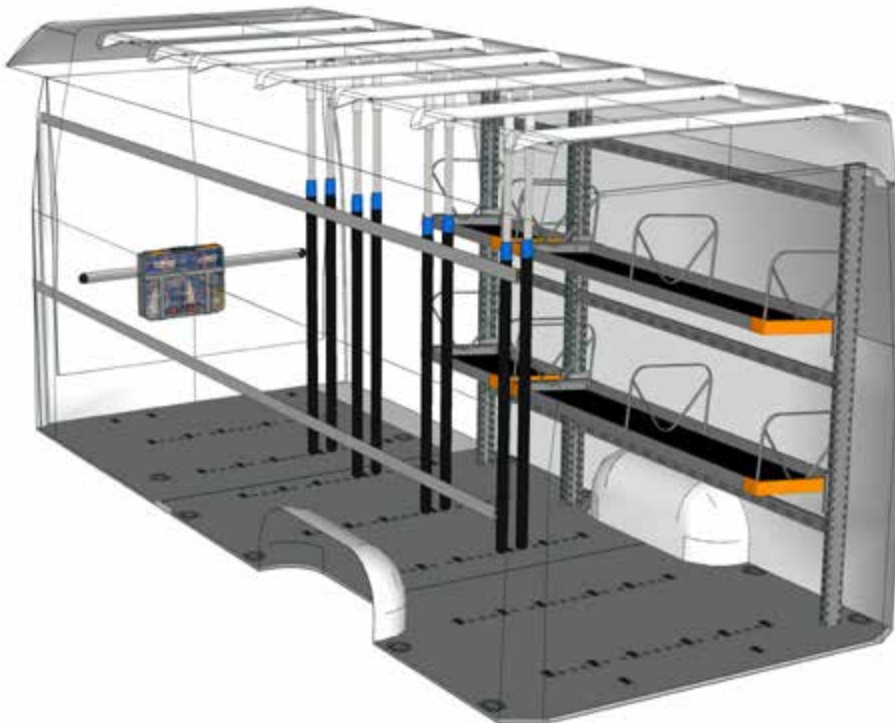

BEISPIEL - EXAMPLE

EXAMPLE SP L3H2 L2 RWD*



- | | |
|--------------------------|--------------------------|
| 1 x SP 2418 L1 | 14 x F22 FC V23389 00 00 |
| 10 x F22 LS 445D30 00 99 | 1 x F22 SB BOX080 00 01 |
| 1 x F22 SF SP30G1 J1 1S | 1 x F22 SB CPV080 00 01 |
| 1 x F22 VT V22585 00 08 | 2 x F22 FC V22136 00 00 |
| 8 x F22 FC V22017 00 00 | 2 x F22 FC V22124 00 00 |
| 1 x F22 FC V18029 15 00 | 2 x F22 FC V22148 00 00 |
| 2 x F22 FC V18029 45 00 | 1 x F22 SB YELLOW 63 05 |
| 4 x F22 FC V22106 00 00 | 4 x F22 FC V22090 00 00 |
| 7 x F22 FC V18025 15 00 | |



* Einschließlich Befestigungskit - Fixing kit included

** Ohne Behälter - Containers not included

Haben Sie Ihre Einrichtung nicht gefunden?
Verlassen Sie sich auf die Profis für Fahrzeugeinrichtungen.
 Auf der Rückseite dieses Katalogs finden Sie die nächstgelegene StoreVan Niederlassung. Besuchen Sie unsere Web-Seite.

Didn't find the equipment you're looking for?
Leave it to our experts.
 See the back of this catalogue and contact the nearest StoreVan point or visit our website.



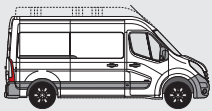

FAHRZEUGEINRICHTUNGSBEISPIELE - FITTINGS EXAMPLES

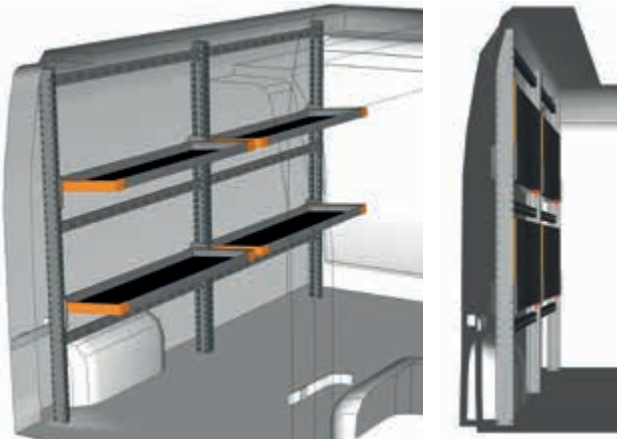

BEISPIEL - EXAMPLE

MA 2618 L1*

B=2620 T=430 H=1772 mm - W=2620 D=430 H=1772 mm

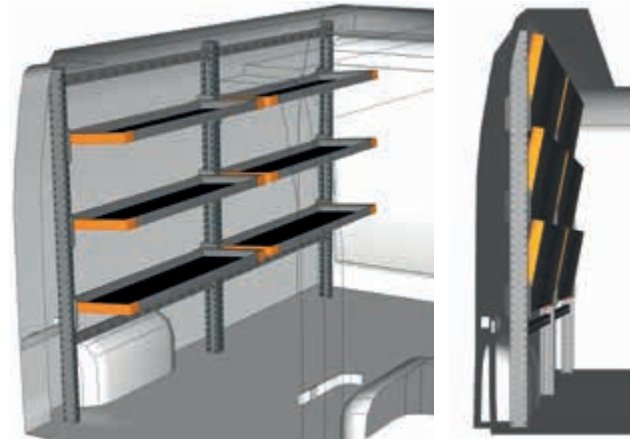
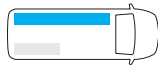

BEISPIEL - EXAMPLE

MA 2618 L2*

B=2620 T=430 H=1772 mm - W=2620 D=430 H=1772 mm

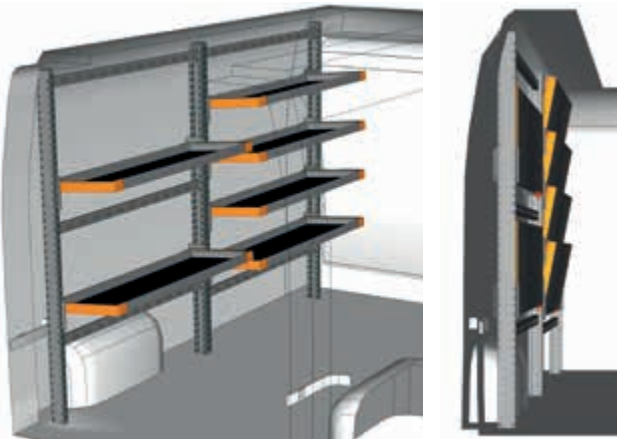
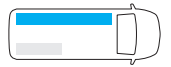

BEISPIEL - EXAMPLE

MA 2618 L3*

B=2620 T=430 H=1772 mm - W=2620 D=430 H=1772 mm

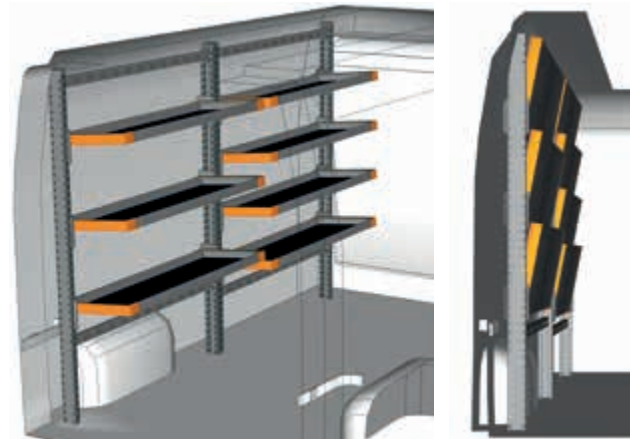
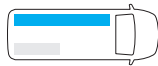

BEISPIEL - EXAMPLE

MA 2618 L4*

B=2620 T=430 H=1772 mm - W=2620 D=430 H=1772 mm

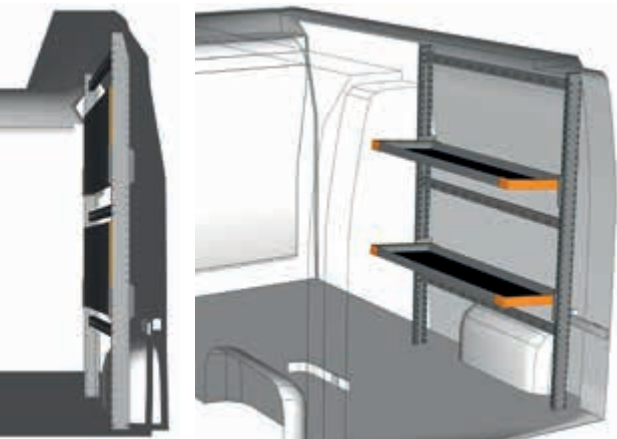

BEISPIEL - EXAMPLE

MA 1318 L1*

B=1310 T=430 H=1772 mm - W=1310 D=430 H=1772 mm

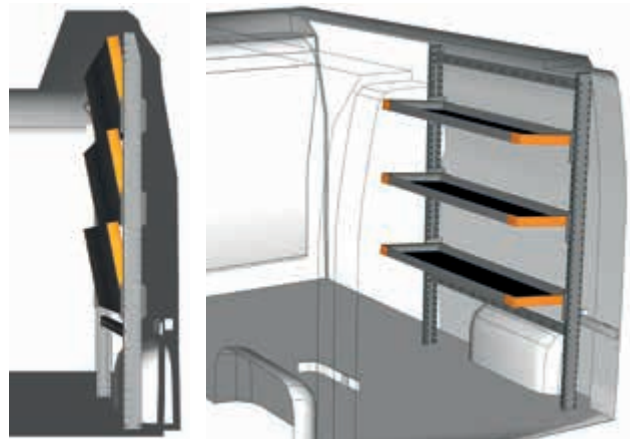

BEISPIEL - EXAMPLE

MA 1318 L2*

B=1310 T=430 H=1772 mm - W=1310 D=430 H=1772 mm



* Einschließlich Befestigungskit - Fixing kit included

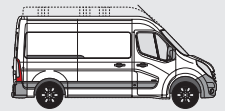

FAHRZEUGEINRICHTUNGSBEISPIELE - FITTINGS EXAMPLES

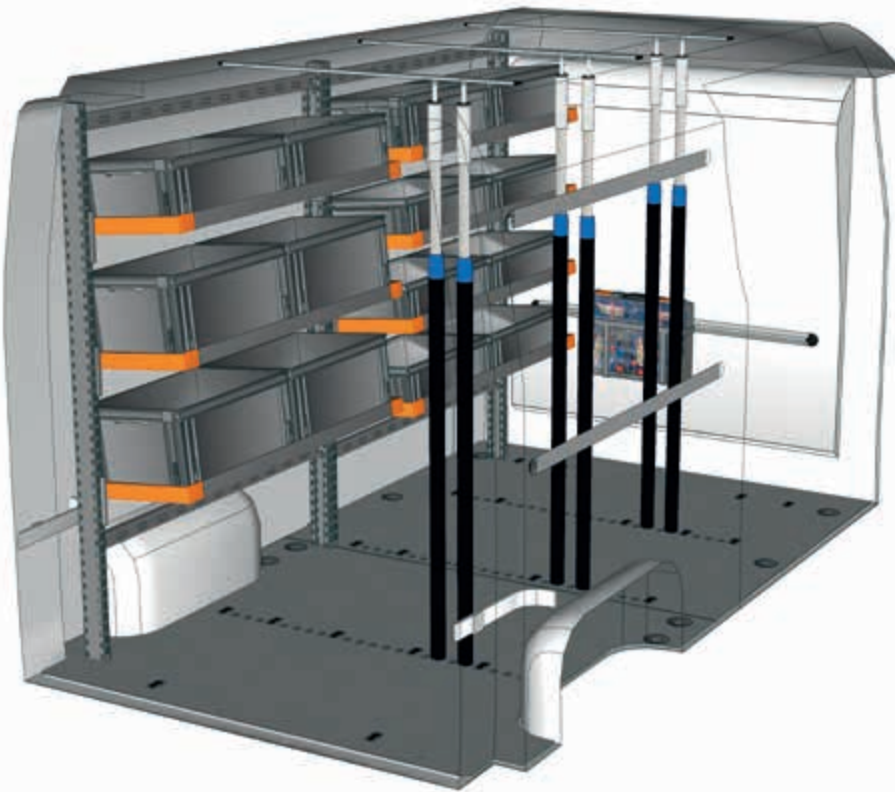

BEISPIEL - EXAMPLE

EXAMPLE MA L2H2 L1 (*) (**)



- | | |
|--------------------------|-------------------------|
| 1 x MA 2618 L4 | 2 x F22 FC V22136 00 00 |
| 1 x F22 SF MA20G1 A0 1S | 2 x F22 FC V22124 00 00 |
| 1 x F22 VT V22585 00 08 | 2 x F22 FC V22148 00 00 |
| 6 x F22 FC V22017 00 00 | 1 x F22 SB YELLOW 63 05 |
| 3 x F22 FC V18029 15 00 | 4 x F22 FC V22582 00 00 |
| 6 x F22 FC V22106 00 00 | |
| 3 x F22 FC V18025 15 00 | |
| 1 x F22 SB BOX0 80 00 01 | |
| 1 x F22 SB CPV080 00 01 | |

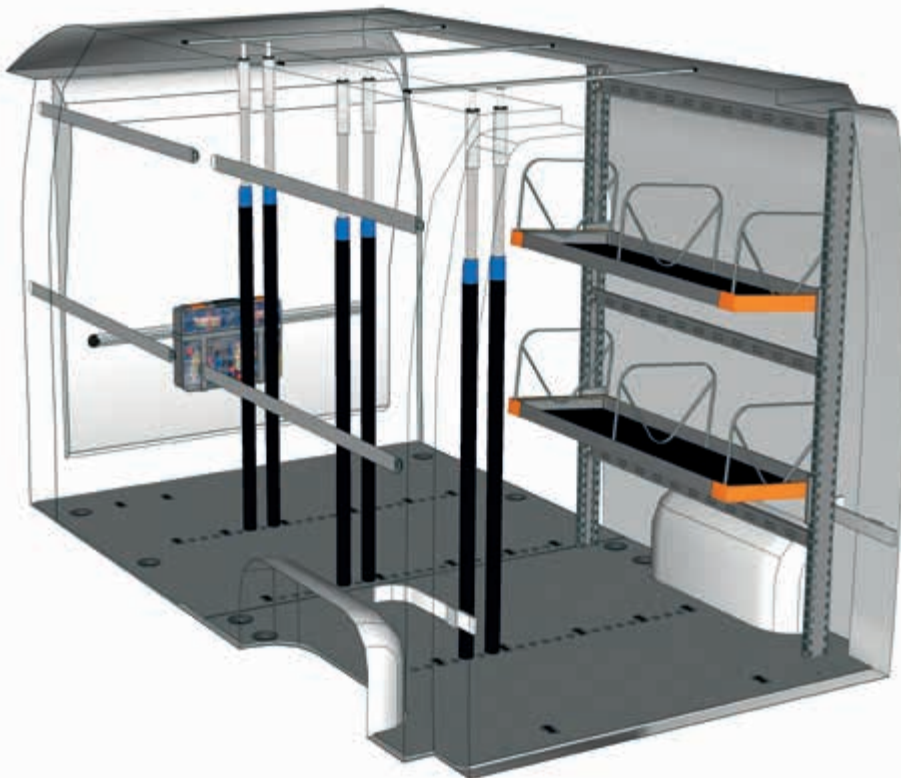

BEISPIEL - EXAMPLE

EXAMPLE MA L2H2 L2*



- | | |
|--------------------------|-------------------------|
| 1 x MA 1318 L1 | 1 x F22 SB CPV080 00 01 |
| 6 x F22 LS 445D30 00 99 | 2 x F22 FC V22136 00 00 |
| 1 x F22 SF MA20G1 A0 1S | 2 x F22 FC V22124 00 00 |
| 1 x F22 VT V22585 00 08 | 2 x F22 FC V22148 00 00 |
| 6 x F22 FC V22017 00 00 | 1 x F22 SB YELLOW 63 05 |
| 5 x F22 FC V18029 15 00 | 4 x F22 FC V22582 00 00 |
| 10 x F22 FC V22106 00 00 | |
| 3 x F22 FC V18025 15 00 | |
| 1 x F22 SB BOX0 80 00 01 | |



* Einschließlich Befestigungskit - Fixing kit included

** Ohne Behälter - Containers not included

Haben Sie Ihre Einrichtung nicht gefunden?
Verlassen Sie sich auf die Profis für Fahrzeugeinrichtungen.
 Auf der Rückseite dieses Katalogs finden Sie die nächstgelegene StoreVan Niederlassung. Besuchen Sie unsere Web-Seite.

Didn't find the equipment you're looking for?
Leave it to our experts.
 See the back of this catalogue and contact the nearest StoreVan point or visit our website.



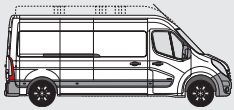

FAHRZEUGEINRICHTUNGSBEISPIELE - FITTINGS EXAMPLES

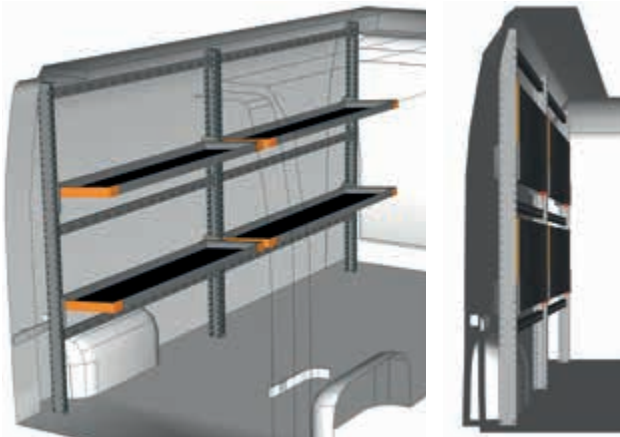

BEISPIEL - EXAMPLE

MA 3218 L1*

B=3257 T=430 H=1772 mm - W=3257 D=430 H=1772 mm

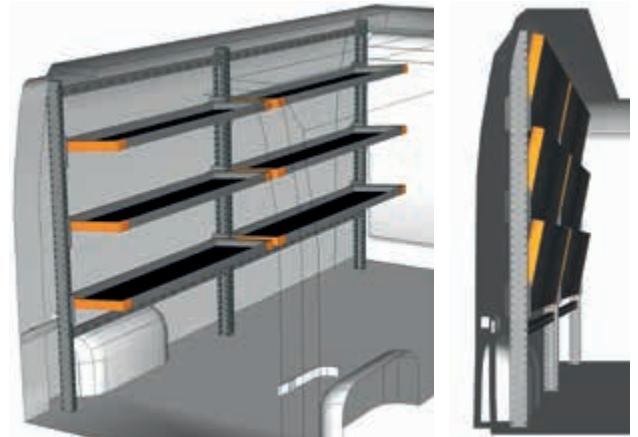
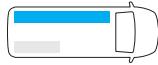

BEISPIEL - EXAMPLE

MA 3218 L2*

B=3257 T=430 H=1772 mm - W=3257 D=430 H=1772 mm

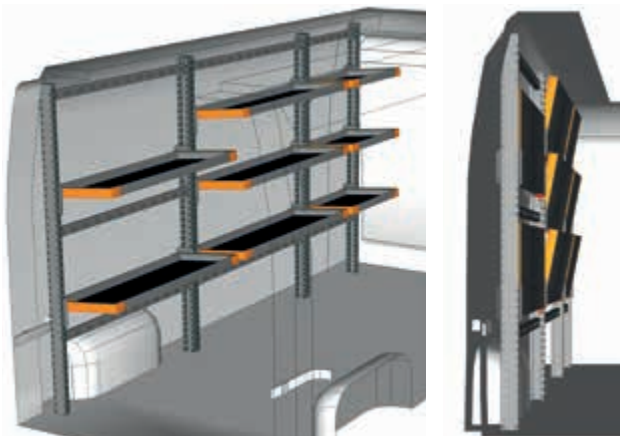

BEISPIEL - EXAMPLE

MA 3218 L3*

B=3252 T=430 H=1772 mm - W=3252 D=430 H=1772 mm

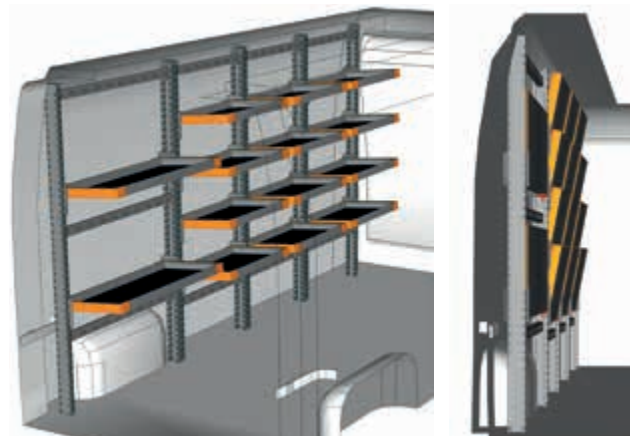

BEISPIEL - EXAMPLE

MA 3218 L4*

B=3167 T=430 H=1772 mm - W=3167 D=430 H=1772 mm



BEISPIEL - EXAMPLE

MA 2018 L1*

B=2027 T=430 H=1772 mm - W=2027 D=430 H=1772 mm

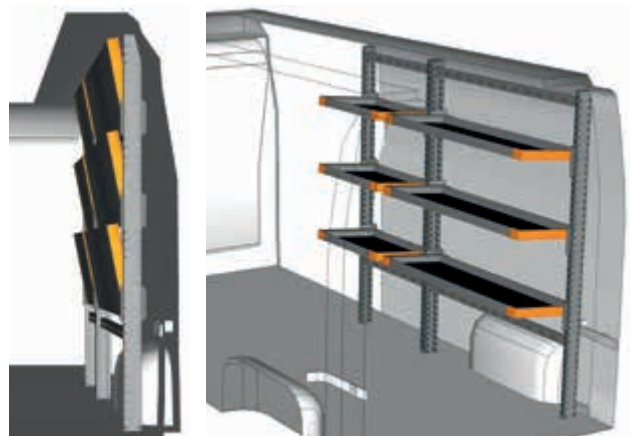

BEISPIEL - EXAMPLE

MA 2018 L2*

B=2027 T=430 H=1772 mm - W=2027 D=430 H=1772 mm



* Einschließlich Befestigungskit - Fixing kit included

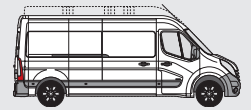

FAHRZEUGEINRICHTUNGSBEISPIELE - FITTINGS EXAMPLES

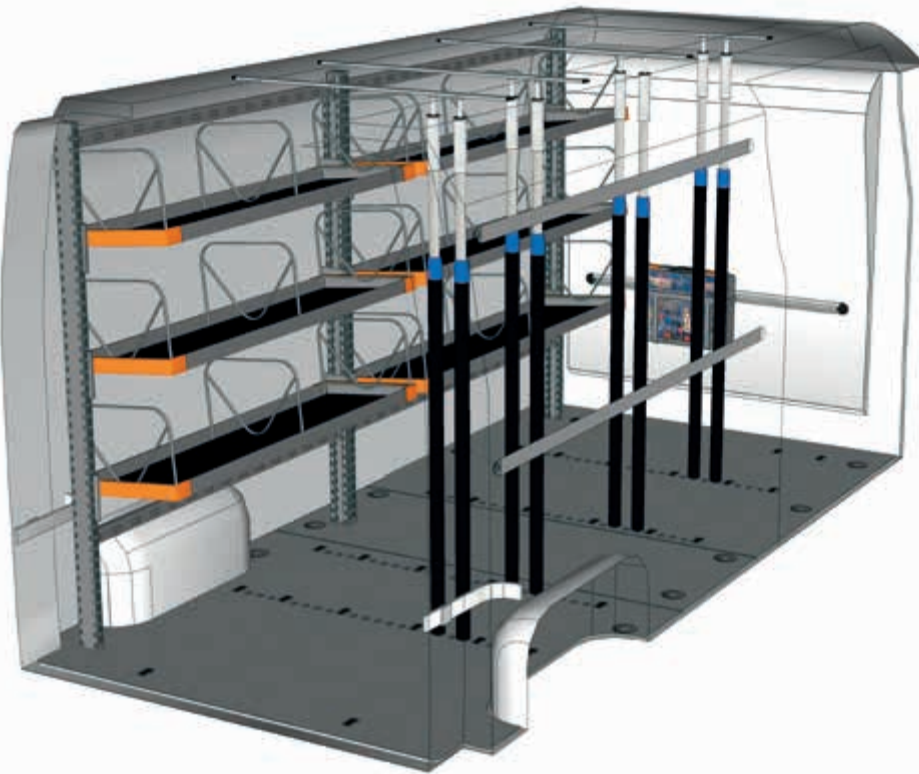

BEISPIEL - EXAMPLE

EXAMPLE MA L3H2 L1*



- | | |
|--------------------------|--------------------------|
| 1 x MA 3218 L2 | 1 x F22 SB BOX0 80 00 01 |
| 18 x F22 LS 445D30 00 99 | 1 x F22 SB CPV080 00 01 |
| 1 x F22 SF MA30G1 A0 1S | 2 x F22 FC V22136 00 00 |
| 1 x F22 VT V22585 00 08 | 2 x F22 FC V22124 00 00 |
| 8 x F22 FC V22017 00 00 | 2 x F22 FC V22148 00 00 |
| 1 x F22 FC V18029 15 00 | 1 x F22 SB YELLOW 63 05 |
| 2 x F22 FC V18029 20 00 | 4 x F22 FC V22582 00 00 |
| 6 x F22 FC V22106 00 00 | |
| 4 x F22 FC V18025 15 00 | |

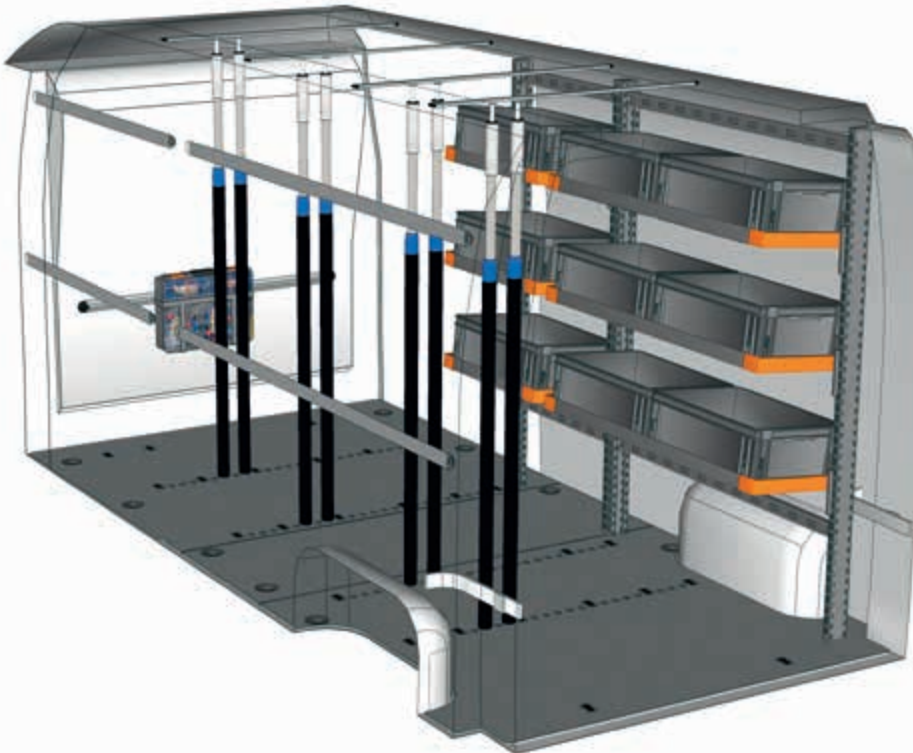

BEISPIEL - EXAMPLE

EXAMPLE MA L3H2 L2>(*)(**)



- | | |
|--------------------------|-------------------------|
| 1 x MA 2018 L2 | 1 x F22 SB CPV080 00 01 |
| 1 x F22 SF MA30G1 A0 1S | 2 x F22 FC V22136 00 00 |
| 1 x F22 VT V22585 00 08 | 2 x F22 FC V22124 00 00 |
| 8 x F22 FC V22017 00 00 | 2 x F22 FC V22148 00 00 |
| 3 x F22 FC V18029 15 00 | 1 x F22 SB YELLOW 63 05 |
| 2 x F22 FC V18029 20 00 | 4 x F22 FC V22582 00 00 |
| 10 x F22 FC V22106 00 00 | |
| 4 x F22 FC V18025 15 00 | |
| 1 x F22 SB BOX080 00 01 | |



* Einschließlich Befestigungskit - Fixing kit included

** Ohne Behälter - Containers not included

Haben Sie Ihre Einrichtung nicht gefunden?
Verlassen Sie sich auf die Profis für Fahrzeugeinrichtungen.
 Auf der Rückseite dieses Katalogs finden Sie die nächstgelegene StoreVan Niederlassung. Besuchen Sie unsere Web-Seite.

Didn't find the equipment you're looking for?
Leave it to our experts.
 See the back of this catalogue and contact the nearest StoreVan point or visit our website.



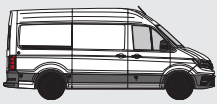

FAHRZEUGEINRICHTUNGSBEISPIELE - FITTINGS EXAMPLES

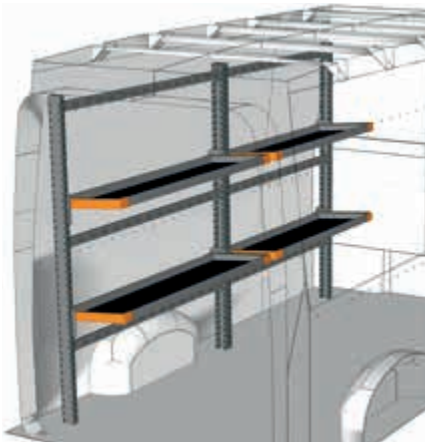

BEISPIEL - EXAMPLE

CR 2818 L1*

B=2834 T=430 H=1772 mm - W=2834 D=430 H=1772 mm

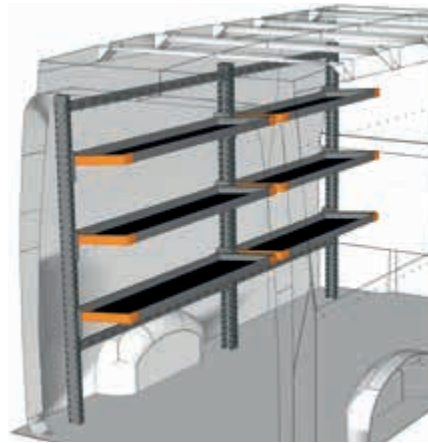
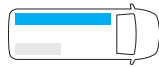

BEISPIEL - EXAMPLE

CR 2818 L2*

B=2834 T=430 H=1772 mm - W=2834 D=430 H=1772 mm

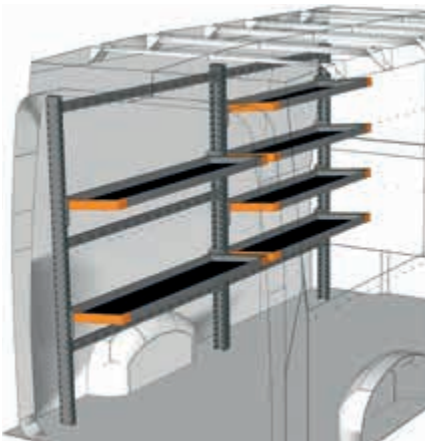
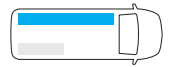

BEISPIEL - EXAMPLE

CR 2818 L3*

B=2834 T=430 H=1772 mm - W=2834 D=430 H=1772 mm

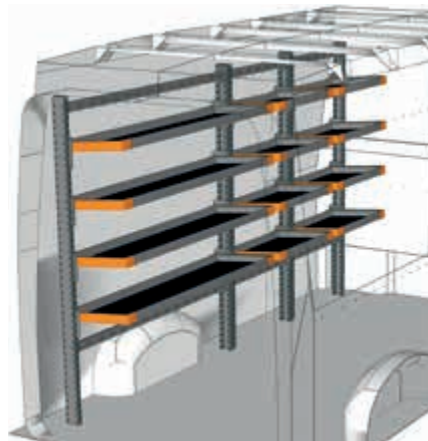
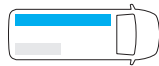

BEISPIEL - EXAMPLE

CR 2818 L4*

B=2958 T=430 H=1772 mm - W=2958 D=430 H=1772 mm

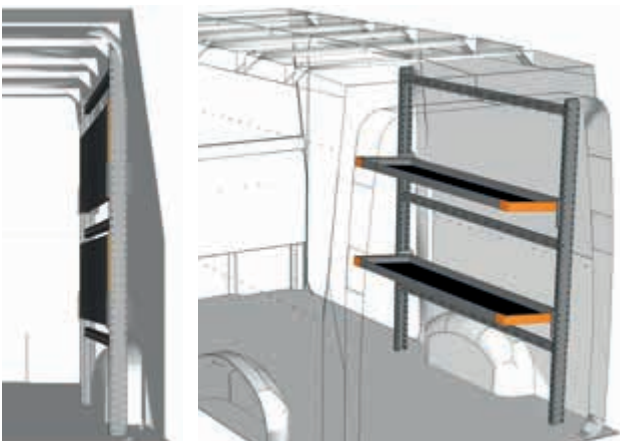

BEISPIEL - EXAMPLE

CR 1518 L1*

B=1524 T=430 H=1772 mm - W=1524 D=430 H=1772 mm

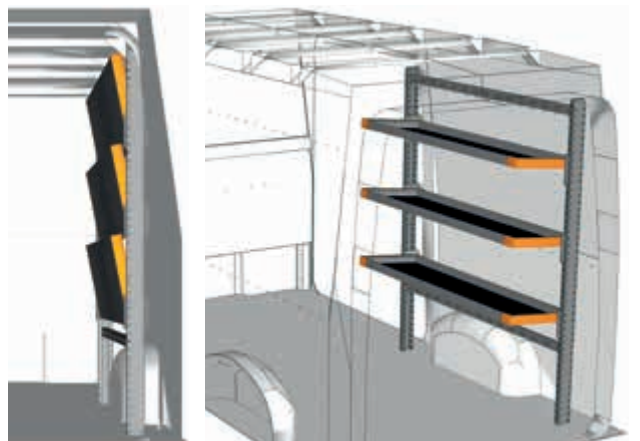
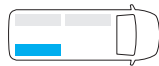

BEISPIEL - EXAMPLE

CR 1518 L2*

B=1524 T=430 H=1772 mm - W=1524 D=430 H=1772 mm



* Einschließlich Befestigungskit - Fixing kit included

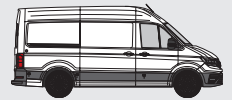

FAHRZEUGEINRICHTUNGSBEISPIELE - FITTINGS EXAMPLES

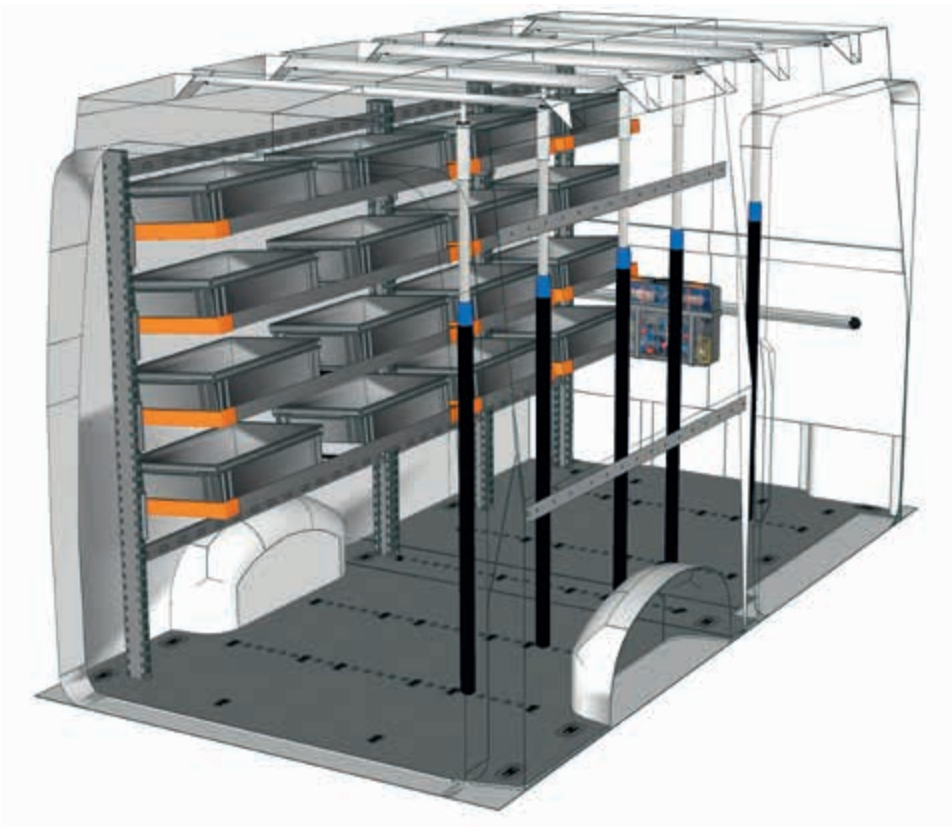

BEISPIEL - EXAMPLE

EXAMPLE CR L3H3 L1 (*)(**)



- | | |
|-------------------------|-------------------------|
| 1 x CR 2818 L4 | 1 x F22 SB CPV080 00 01 |
| 8 x F22 LS 445D05 00 00 | 2 x F22 FC V22136 00 00 |
| 1 x F22 SF CR30G1 A0 1S | 2 x F22 FC V22124 00 00 |
| 1 x F22 VT V22585 00 08 | 2 x F22 FC V22148 00 00 |
| 5 x F22 FC V22017 00 00 | 1 x F22 SB YELLOW 63 05 |
| 3 x F22 FC V18029 15 00 | 4 x F22 FC V22582 00 00 |
| 2 x F22 FC V22106 00 00 | |
| 5 x F22 FC V18025 15 00 | |
| 1 x F22 SB BOX080 00 01 | |

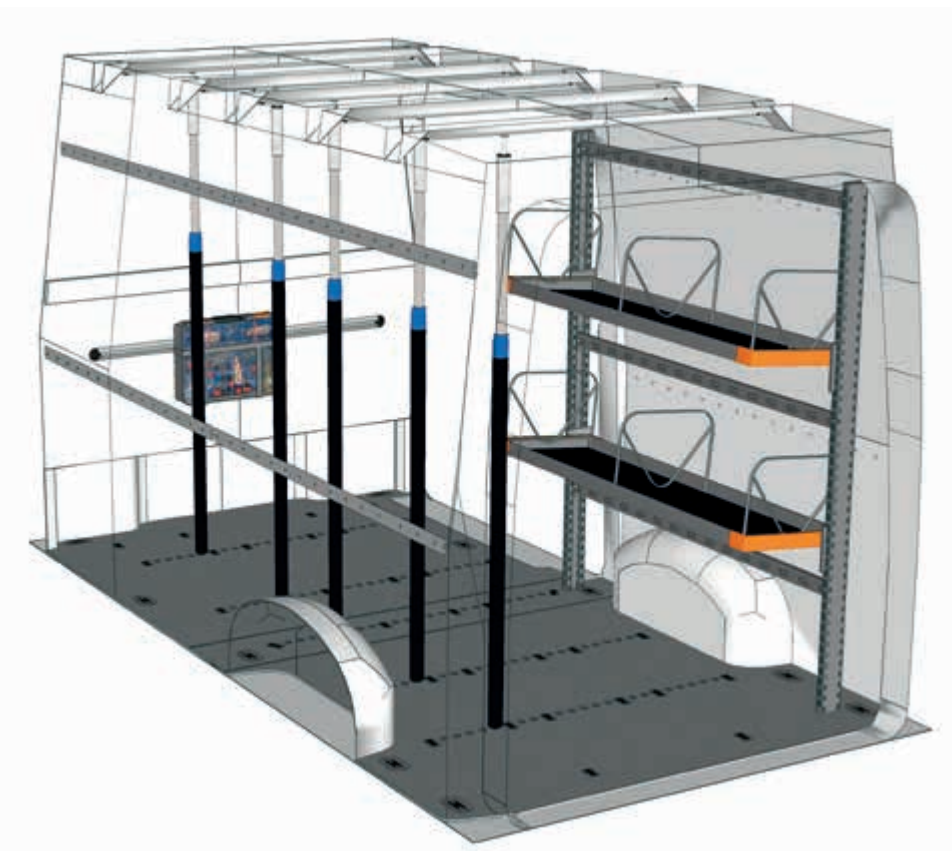

BEISPIEL - EXAMPLE

EXAMPLE CR L3H3 L2*



- | | |
|-------------------------|-------------------------|
| 1 x CR 1518 L1 | 1 x F22 SB CPV080 00 01 |
| 6 x F22 LS 445D30 00 99 | 2 x F22 FC V22136 00 00 |
| 1 x F22 SF CR30G1 A0 1S | 2 x F22 FC V22124 00 00 |
| 1 x F22 VT V22585 00 08 | 2 x F22 FC V22148 00 00 |
| 5 x F22 FC V22017 00 00 | 1 x F22 SB YELLOW 63 05 |
| 5 x F22 FC V18029 15 00 | 4 x F22 FC V22582 00 00 |
| 2 x F22 FC V22106 00 00 | |
| 5 x F22 FC V18025 15 00 | |
| 1 x F22 SB BOX080 00 01 | |



Haben Sie Ihre Einrichtung nicht gefunden?
Verlassen Sie sich auf die Profis für Fahrzeugeinrichtungen.
 Auf der Rückseite dieses Katalogs finden Sie die nächstgelegene StoreVan Niederlassung. Besuchen Sie unsere Web-Seite.

Didn't find the equipment you're looking for?
Leave it to our experts.
 See the back of this catalogue and contact the nearest StoreVan point or visit our website.



* Einschließlich Befestigungskit - Fixing kit included

** Ohne Behälter - Containers not included

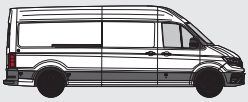

FAHRZEUGEINRICHTUNGSBEISPIELE - FITTINGS EXAMPLES

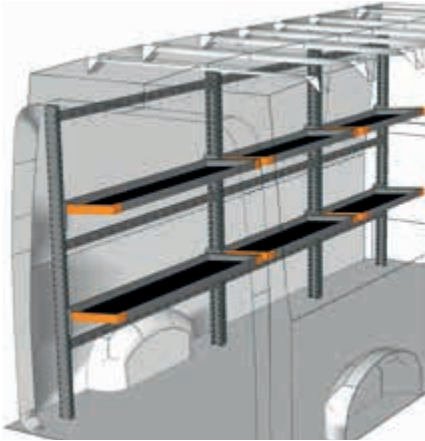

BEISPIEL - EXAMPLE

CR 3718 L1*

B=3765 T=430 H=1772 mm - W=3765 D=430 H=1772 mm

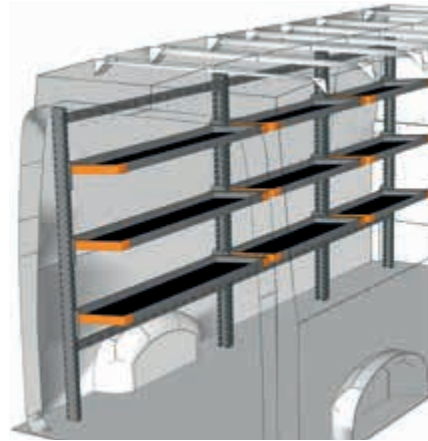
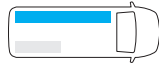

BEISPIEL - EXAMPLE

CR 3718 L2*

B=3765 T=430 H=1772 mm - W=3765 D=430 H=1772 mm

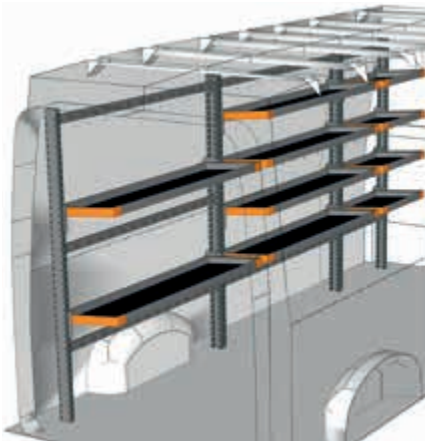
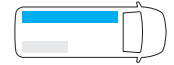

BEISPIEL - EXAMPLE

CR 3718 L3*

B=3765 T=430 H=1772 mm - W=3765 D=430 H=1772 mm

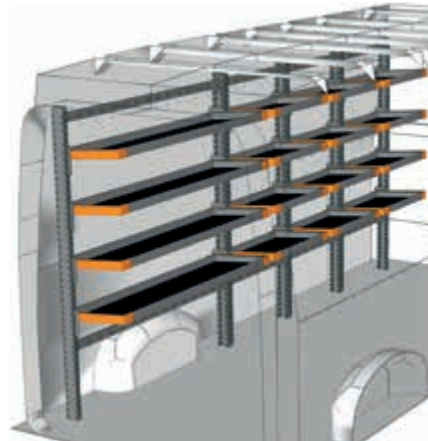

BEISPIEL - EXAMPLE

CR 3718 L4*

B=3675 T=430 H=1772 mm - W=3675 D=430 H=1772 mm

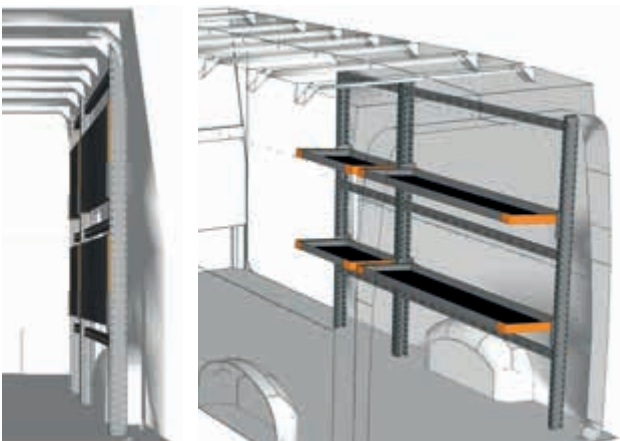
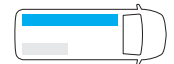

BEISPIEL - EXAMPLE

CR 2218 L1*

B=2241 T=430 H=1772 mm - W=2241 D=430 H=1772 mm

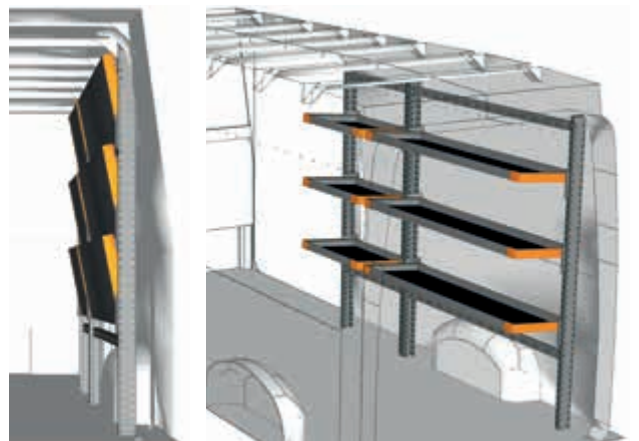

BEISPIEL - EXAMPLE

CR 2218 L2*

B=2241 T=430 H=1772 mm - W=2241 D=430 H=1772 mm



* Einschließlich Befestigungskit - Fixing kit included

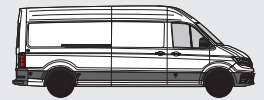

FAHRZEUGEINRICHTUNGSBEISPIELE - FITTINGS EXAMPLES

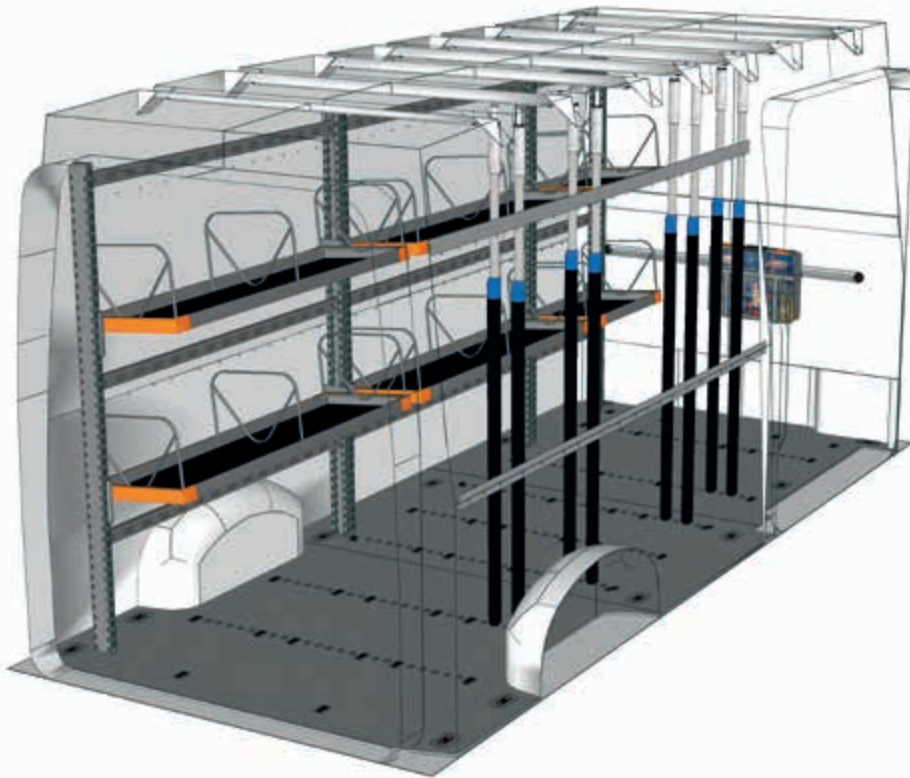

BEISPIEL - EXAMPLE

EXAMPLE CR L4H3 L1*



- | | |
|--------------------------|-------------------------|
| 1 x CR 3718 L1 | 1 x F22 SB BOX080 00 01 |
| 16 x F22 LS 445D30 00 99 | 1 x F22 SB CPV080 00 01 |
| 1 x F22 SF CR40G1 A0 1S | 2 x F22 FC V22136 00 00 |
| 1 x F22 VT V22585 00 08 | 2 x F22 FC V22124 00 00 |
| 8 x F22 FC V22017 00 00 | 2 x F22 FC V22148 00 00 |
| 1 x F22 FC V18029 15 00 | 1 x F22 SB YELLOW 63 05 |
| 2 x F22 FCV 18029 25 00 | 4 x F22 FC V22582 00 00 |
| 2 x F22 FC V22106 00 00 | |
| 7 x F22 FC V18025 15 00 | |

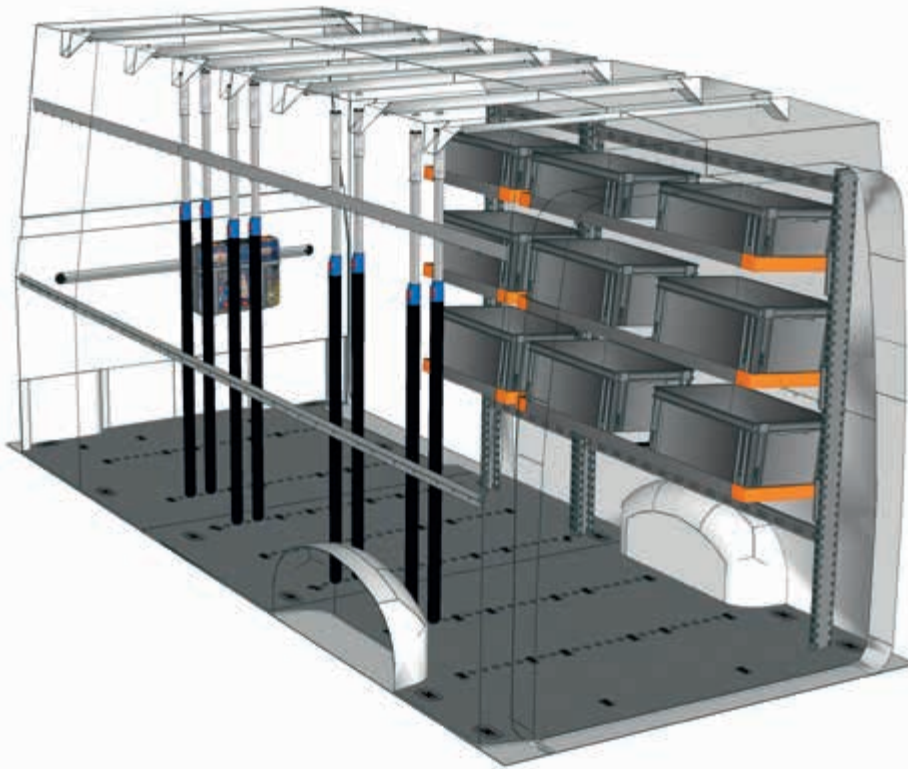

BEISPIEL - EXAMPLE

EXAMPLE CR L4H3 L2>(*)(**)



- | | |
|-------------------------|-------------------------|
| 1 x CR 2218 L2 | 1 x F22 SB BOX080 00 01 |
| 6 x F22 LS 445D05 00 00 | 1 x F22 SB CPV080 00 01 |
| 1 x F22 SF CR40G1 A0 1S | 2 x F22 FC V22136 00 00 |
| 1 x F22 VT V22585 00 08 | 2 x F22 FC V22124 00 00 |
| 8 x F22 FC V22017 00 00 | 2 x F22 FC V22148 00 00 |
| 3 x F22 FC V18029 15 00 | 1 x F22 SB YELLOW 63 05 |
| 2 x F22 FCV 18029 25 00 | 4 x F22 FC V22582 00 00 |
| 2 x F22 FC V22106 00 00 | |
| 7 x F22 FC V18025 15 00 | |



* Einschließlich Befestigungskit - Fixing kit included

** Ohne Behälter - Containers not included

Haben Sie Ihre Einrichtung nicht gefunden?
Verlassen Sie sich auf die Profis für Fahrzeugeinrichtungen.
 Auf der Rückseite dieses Katalogs finden Sie die nächstgelegene StoreVan Niederlassung. Besuchen Sie unsere Web-Seite.

Didn't find the equipment you're looking for?
Leave it to our experts.
 See the back of this catalogue and contact the nearest StoreVan point or visit our website.



LIGHT SHELF

KLAPPREGALE FÜR TRANSPORTER
FOLDABLE VAN SHELVING SYSTEM



FAMI S.R.L.

VIA STAZIONE ROSSANO, 13 – 36027 ROSÀ (VI) ITALY
TEL +39 0424 585455 R.A. – FAX +39 0424 585482
INFO@FAMISPA.COM – WWW.FAMISPA.COM

INFO@STOREVAN.COM – WWW.STOREVAN.COM

