



FITTINGS FOR COMMERCIAL VEHICLES



STORE BOXSERIES



STORE BOX067
page 4



STORE BOX080
page 6



STORE BOX102
page 10



STORE BOX136
page 12



STORE BOX238
page 14



STORE BOX374
page 16



STORE BOXTRAY
page 18



STORE ROLL
page 22





**STORE
BOXDIVIDER**
page 20



**STORE
CADDY**
page 23



STORE BOX067

ITEM NO. F 22 SB BOX067 00 01

Steel case - empty W=438 D=347 H=67 mm



ITEM NO. F 22 SB BOX067 01 01

Steel case with 48 compartments:
48 "red" inset boxes



ITEM NO. F 22 SB BOX067 02 01

Steel case with 24 compartments:
24 "yellow" inset boxes



ITEM NO. F 22 SB BOX067 03 01

Steel case with 12 compartments:
12 "blue" inset boxes



ITEM NO. F 22 SB BOX067 04 01

Steel case with 8 compartments:
8 "green" inset boxes



ITEM NO. F 22 SB BOX067 05 01

Steel case with 4 compartments:
4 "forest" inset boxes



ITEM NO. F 22 SB BOX067 06 01

Steel case with 23 compartments:
12 "red" inset boxes
6 "yellow" inset boxes
3 "blue" inset boxes
2 "green" inset boxes



ITEM NO. F 22 SB BOX067 07 01

Steel case with 16 compartments:
 6 "red" inset boxes
 5 "yellow" inset boxes
 2 "blue" inset boxes
 2 "green" inset boxes
 1 "forest" inset box



ITEM NO. F 22 SB BOX067 08 01

Steel case with 10 compartments:
 3 "yellow" inset boxes
 3 "blue" inset boxes
 3 "green" inset boxes
 1 "forest" inset box



ITEM NO. F 22 SB BOX067 09 01

Steel case with 22 compartments:
 12 "red" inset boxes
 6 "yellow" inset boxes
 3 "blue" inset boxes
 1 "forest" inset box



STORE BOX080

ITEM NO. F 22 SB BOX080 00 01

Plastic case - empty W=440 D=350 H=80 mm



ITEM NO. F 22 SB BOX080 01 01

Plastic case with 48 compartments:
48 "red" inset boxes



ITEM NO. F 22 SB BOX080 02 01

Plastic case with 24 compartments:
24 "yellow" inset boxes



ITEM NO. F 22 SB BOX080 03 01

Plastic case with 12 compartments:
12 "blue" inset boxes



ITEM NO. F 22 SB BOX080 04 01

Plastic case with 8 compartments:
8 "green" inset boxes



ITEM NO. F 22 SB BOX080 05 01

Plastic case with 4 compartments:
4 "forest" inset boxes



ITEM NO. F 22 SB BOX080 06 01

Plastic case with 23 compartments:
12 "red" inset boxes
6 "yellow" inset boxes
3 "blue" inset boxes
2 "green" inset boxes

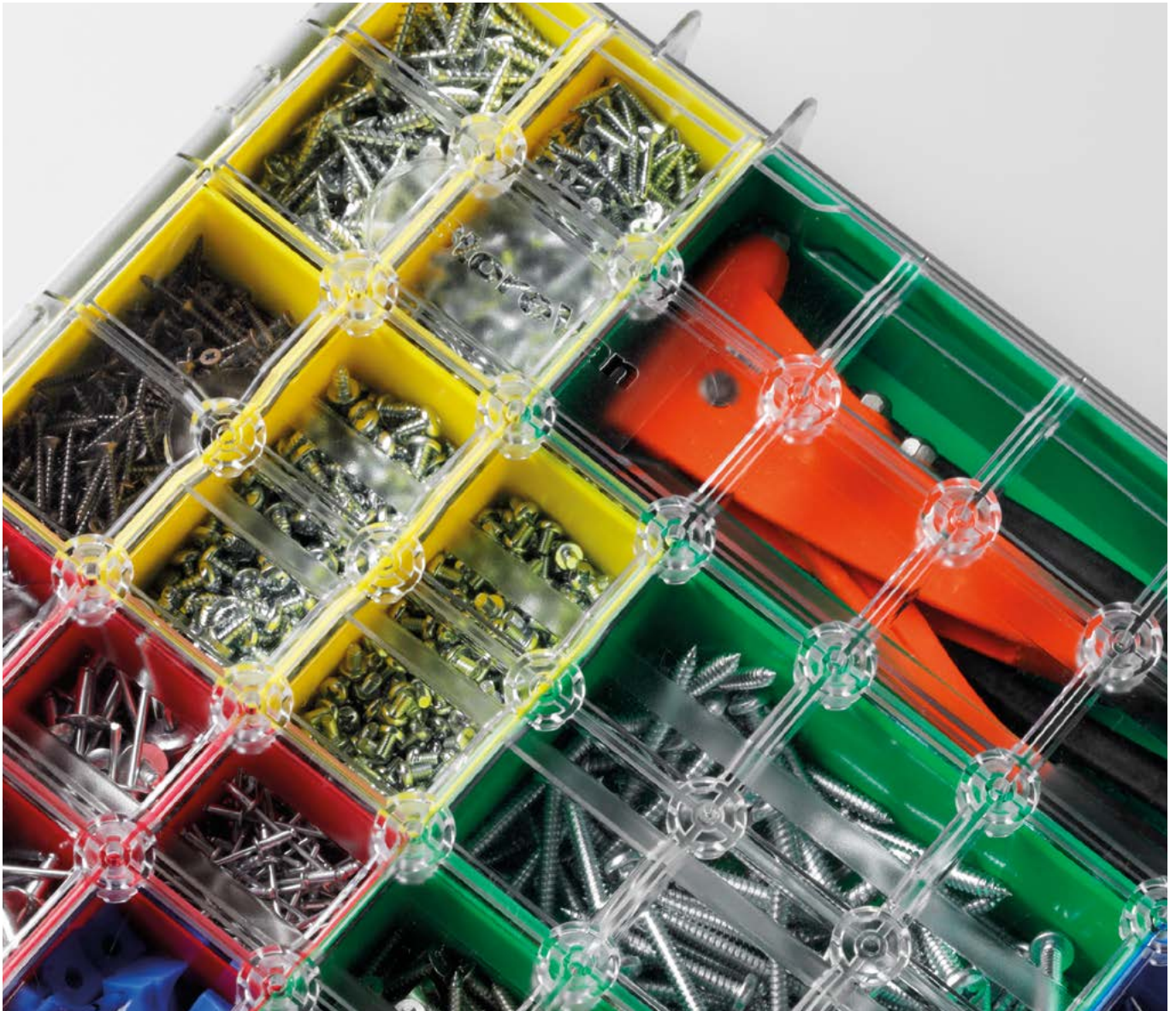

ITEM NO. F 22 SB BOX080 07 01

Plastic case with 16 compartments:
 6 "red" inset boxes
 5 "yellow" inset boxes
 2 "blue" inset boxes
 2 "green" inset boxes
 1 "forest" inset box



ITEM NO. F 22 SB BOX080 08 01

Plastic case with 10 compartments:
 3 "yellow" inset boxes
 3 "blue" inset boxes
 3 "green" inset boxes
 1 "forest" inset box



ITEM NO. F 22 SB BOX080 09 01

Plastic case with 22 compartments:
 12 "red" inset boxes
 6 "yellow" inset boxes
 3 "blue" inset boxes
 1 "forest" inset box



STORE BOX102

ITEM NO. F 22 SB BOX102 00 01

Plastic case - empty W=442 D=357 H=117 mm



ITEM NO. F 22 SB BOX102 01 01

Plastic case with 23 compartments:
1 sky lid insert
2 "grey" inset boxes with dividers
6 "red" inset boxes
6 "yellow" inset boxes
3 "blue" inset boxes



ITEM NO. F 22 SB BOX102 02 01

Plastic case with 19 compartments:
1 sky lid insert
2 "grey" inset boxes with dividers
4 "red" inset boxes
3 "yellow" inset boxes
2 "blue" inset boxes
2 "green" inset boxes



ITEM NO. F 22 SB BOX102 03 01

Plastic case with 18 compartments:
1 sky lid insert
2 "grey" inset boxes with dividers
4 "red" inset boxes
3 "yellow" inset boxes
2 "blue" inset boxes
1 "forest" inset box



ITEM NO. F 22 SB BOX102 04 01

Plastic case with 38 compartments:
1 sky lid insert
2 "grey" inset boxes with dividers
30 "red" inset boxes



ITEM NO. F 22 SB BOX102 05 01

Plastic case with 23 compartments:
1 sky lid insert
2 "grey" inset boxes with dividers
15 "yellow" inset boxes



ITEM NO. F 22 SB BOX102 06 01

Plastic case with 13 compartments:
1 sky lid insert
2 "grey" inset boxes with dividers
5 "green" inset boxes

ITEM NO. F 22 SB BOX102 07 01

Plastic case with 14 compartments:
 1 sky lid insert
 2 "grey" inset boxes with dividers
 2 "red" inset boxes
 2 "yellow" inset boxes
 2 "forest" inset boxes

ITEM NO. F 22 SB BOX102 08 01

Plastic case with 17 compartments:
 1 sky lid insert
 2 "grey" inset boxes with dividers
 3 "yellow" inset boxes
 6 "blue" inset boxes

ITEM NO. F 22 SB BOX102 09 01

Plastic case with 14 compartments:
 1 sky lid insert
 2 "grey" inset boxes with dividers
 3 "blue" inset boxes
 3 "green" inset boxes

ITEM NO. F 22 SB BOX102 10 01

Plastic case with:
 1 sky lid insert
 2 "grey" inset boxes with dividers
 2 store box mini63

ITEM NO. F 22 SB BOX102 11 01

Plastic case with:
 1 sky lid insert
 1 "dark" thermo-formed insert with 5 compartments

ITEM NO. F 22 SB BOX102 12 01

Plastic case with:
 1 sky lid insert
 1 "dark" thermo-formed insert with 12 compartments



STORE BOX102

ITEM NO. F 22 SB BOX102 00 01

Plastic case - empty W=442 D=357 H=117 mm

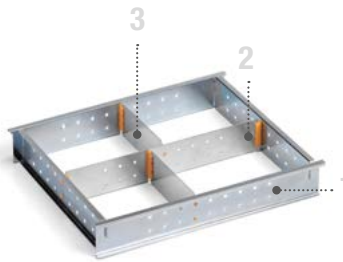

ITEM NO. F 22 SB FRA102 01 99

W=406 D=319 H=61 mm
Divider set with:
1 frame FRA102
1 divider D35102
2 dividers D13102

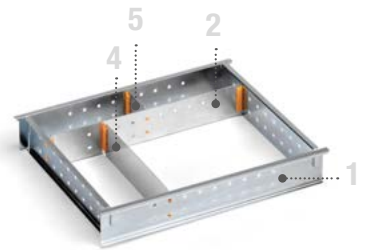

ITEM NO. F 22 SB FRA102 02 99

W=406 D=319 H=61 mm
Divider set with:
1 frame FRA102
1 divider D35102
1 divider D06102
1 divider D21102



2

ITEM NO. F 22 SB D35102 00 00

Horizontal aluminium divider for frame BOX102
W=352 D=12 H=61 mm



3

ITEM NO. F 22 SB D13102 00 00

Longitudinal aluminium divider for frame BOX102
W=139 H=60 mm



1

ITEM NO. F 22 SB FRA102 00 99

Galvanised steel frame for case BOX102
W=406 D=319 H=61 mm



4

ITEM NO. F 22 SB D21102 00 00

Longitudinal aluminium divider for frame BOX102
W=218 H=60 mm



5

ITEM NO. F 22 SB D06102 00 00

Longitudinal aluminium divider for frame BOX102
W=61 H=60 mm



ITEM NO. F 22 SB MAT001 00 07

Non-slip rubber mat for
BOX102 - 136 - 238
W=362 D=300 H=1,5 mm

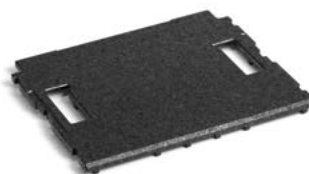

ITEM NO. F 22 SB SKY001 00 07

Sky lid insert in expanded polypropylene
W=400 D=320 H=20 mm

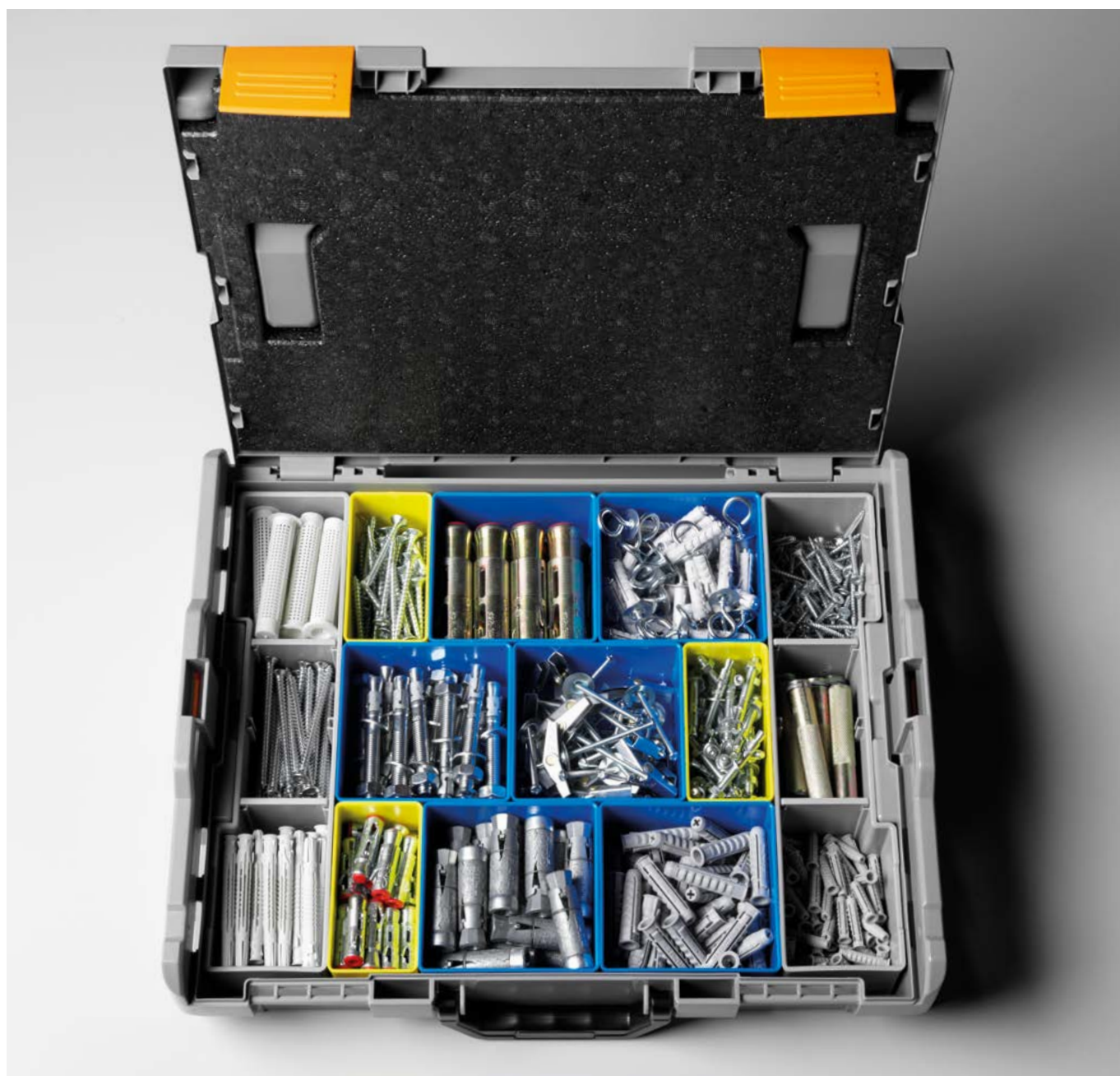



STORE BOX136

ITEM NO. F 22 SB BOX136 00 01

Plastic case - empty W=442 D=357 H=151 mm

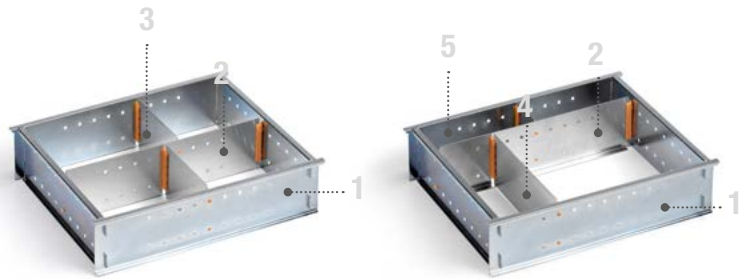

ITEM NO. F 22 SB FRA136 01 99

W=406 D=319 H=96 mm
Divider set with:
1 frame FRA136
1 divider D35136
2 dividers D13136

ITEM NO. F 22 SB FRA136 02 99

W=406 D=319 H=96 mm
Divider set with:
1 frame FRA136
1 divider D35136
1 divider D06136
1 divider D21136



2

ITEM NO. F 22 SB D35136 00 00

Horizontal aluminium divider for
frame BOX136
W=352 D=12 H=96 mm



3

ITEM NO. F 22 SB D13136 00 00

Longitudinal aluminium divider
for frame BOX136
W=139 H=95 mm



1

ITEM NO. F 22 SB FRA136 00 99

Galvanised steel frame for case
BOX136
W=406 D=319 H=96 mm



4

ITEM NO. F 22 SB D21136 00 00

Longitudinal aluminium divider
for frame BOX136
W=218 H=95 mm



5

ITEM NO. F 22 SB D06136 00 00

Longitudinal aluminium divider
for frame BOX136
W=61 H=95 mm



ITEM NO. F 22 SB MAT001 00 07

Non-slip rubber mat for
BOX102 - 136 - 238
W=362 D=300 H=1,5 mm

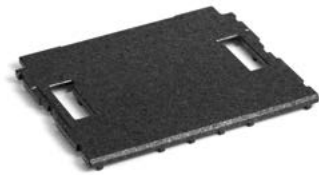

ITEM NO. F 22 SB SKY001 00 07

Sky lid insert in expanded polypropylene
W=400 D=320 H=20 mm



Sky lid insert

Tray with divider
set, see page 18



1

ITEM NO. F 22 SB SUP136 00 99

Galvanised steel support for case BOX136
W=401 D=311 H=33 mm





STORE BOX238

ITEM NO. F 22 SB BOX238 00 01

Plastic case - empty W=442 D=357 H=253 mm

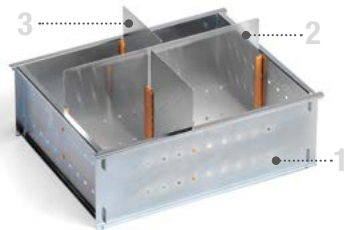

ITEM NO. F 22 SB FRA238 03 99

W=402 D=312 H=194 mm

Divider set with:

1 frame FRA238

1 divider D36238

2 dividers D14238



1

ITEM NO. F 22 SB FRA238 00 99

Galvanized steel frame for case
BOX238 - BOX374
W=402 D=312 H=132 mm



2

ITEM NO. F 22 SB D36238 00 00

Horizontal aluminium divider for
frame BOX238
W=352 D=12 H=194 mm



3

ITEM NO. F 22 SB D14238 00 00

Longitudinal aluminium divider
for frame BOX238
W=135 H=193 mm



ITEM NO. F 22 SB MAT001 00 07

Non-slip rubber mat for
BOX102 - 136 - 238
W=362 D=300 H=1,5 mm

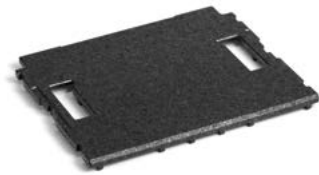

ITEM NO. F 22 SB SKY001 00 07

Sky lid insert in expanded polypropylene
W=400 D=320 H=20 mm



Sky lid insert

Tray with divider set, see page 18

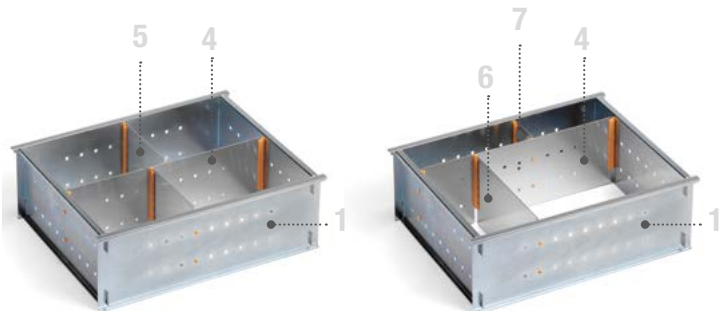

ITEM NO. F 22 SB FRA238 01 99

W=402 D=312 H=132 mm
Divider set with:
1 frame FRA238
1 divider D35238
2 dividers D13238

ITEM NO. F 22 SB FRA238 02 99

W=402 D=312 H=132 mm
Divider set with:
1 frame FRA238
1 divider D05238
1 divider D21238



1

ITEM NO. F 22 SB FRA238 00 99

Galvanised steel frame for case
BOX238 - BOX374
W=402 D=312 H=132 mm



4

ITEM NO. F 22 SB D35238 00 00

Horizontal aluminium divider for
frame BOX238
W=352 D=12 H=132 mm



5

ITEM NO. F 22 SB D13238 00 00

Longitudinal aluminium divider
for frame BOX238
W=135 H=131 mm



6

ITEM NO. F 22 SB D21238 00 00

Longitudinal aluminium divider
for frame BOX238
W=213 H=131 mm



7

ITEM NO. F 22 SB D05238 00 00

Longitudinal aluminium divider
for frame BOX238
W=57 H=131 mm



STORE BOX374

ITEM NO. F 22 SB BOX374 00 01

Plastic case - empty W=442 D=357 H=389 mm

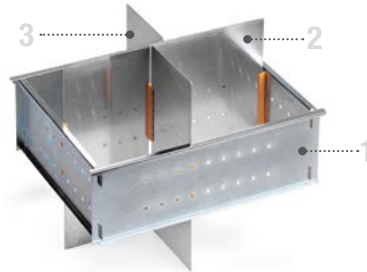

ITEM NO. F 22 SB FRA374 01 99

W=402 D=312 H=330 mm

Divider set with:

1 frame FRA238

1 divider D36374

2 dividers D14374



1

ITEM NO. F 22 SB FRA238 00 99

Galvanised steel frame for case
BOX238 - BOX374
W=402 D=312 H=132 mm



2

ITEM NO. F 22 SB D36374 00 00

Horizontal aluminium divider for
frame BOX374
W=352 D=12 H=330 mm



3

ITEM NO. F 22 SB D14374 00 00

Longitudinal aluminium divider
for frame BOX374
W=135 H=329 mm



ITEM NO. F 22 SB MAT002 00 07

Non-slip rubber mat for
BOX374
W=362 D=290 H=1,5 mm

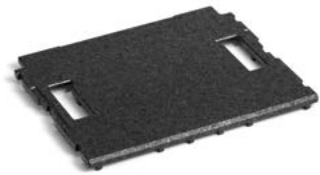

ITEM NO. F 22 SB SKY001 00 07

Sky lid insert in expanded polypropylene
W=400 D=320 H=20 mm

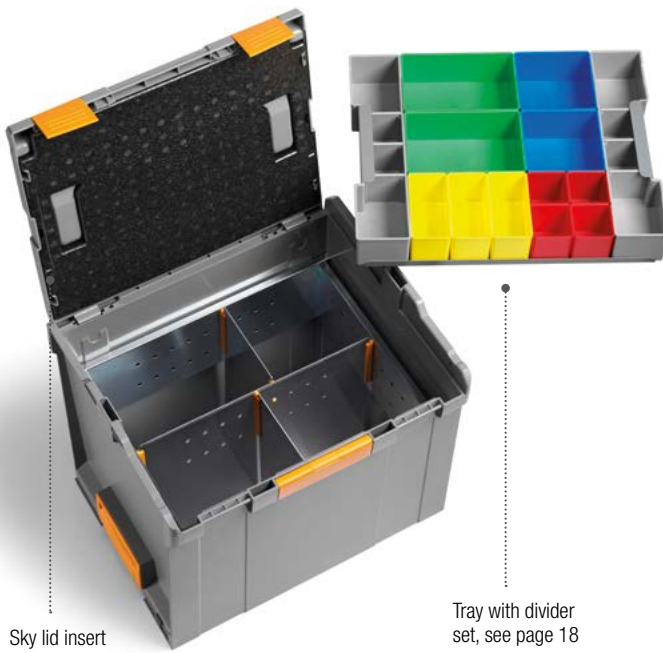

Sky lid insert

Tray with divider set, see page 18

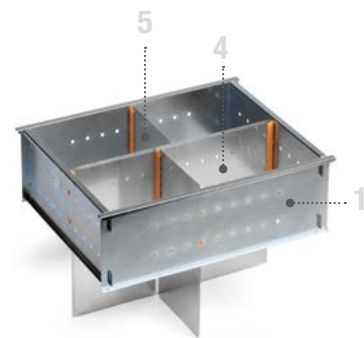

ITEM NO. F 22 SB FRA374 02 99

W=402 D=312 H=260 mm
Divider set with:
1 frame FRA238
1 divider D35374
2 dividers D13374



ITEM NO. F 22 SB FRA238 00 99

Galvanised steel frame for case
BOX238 - BOX374
W=402 D=312 H=132 mm



ITEM NO. F 22 SB D35374 00 00

Horizontal aluminium divider for
frame BOX374
W=352 D=12 H=260 mm



ITEM NO. F 22 SB D13374 00 00

Longitudinal aluminium divider
for frame BOX374
W=135 H=259 mm



STORE BOXTRAY

ITEM NO. F 22 SB 00TRAY 00 01

Steel tray, empty for Store Box 136 - 238 - 374
W=380 D=313 H=65 mm



ITEM NO. F 22 SB 00TRAY 01 01

Steel tray with 23 compartments:
2 "grey" inset boxes with dividers
6 "red" inset boxes
6 "yellow" inset boxes
3 "blue" inset boxes



ITEM NO. F 22 SB 00TRAY 02 01

Steel tray with 19 compartments:
2 "grey" inset boxes with dividers
4 "red" inset boxes
3 "yellow" inset boxes
2 "blue" inset boxes
2 "green" inset boxes



ITEM NO. F 22 SB 00TRAY 03 01

Steel tray with 18 compartments:
2 "grey" inset boxes with dividers
4 "red" inset boxes
3 "yellow" inset boxes
2 "blue" inset boxes
1 "forest" inset box



ITEM NO. F 22 SB 00TRAY 04 01

Steel tray with 38 compartments:
2 "grey" inset boxes with dividers
30 "red" inset boxes



ITEM NO. F 22 SB 00TRAY 05 01

Steel tray with 23 compartments:
2 "grey" inset boxes with dividers
15 "yellow" inset boxes



ITEM NO. F 22 SB 00TRAY 06 01

Steel tray with 13 compartments:
2 "grey" inset boxes with dividers
5 "green" inset boxes

ITEM NO. F 22 SB 00TRAY 07 01

Steel tray with 14 compartments:
 2 "grey" inset boxes with dividers
 2 "red" inset boxes
 2 "yellow" inset boxes
 2 "forest" inset boxes

ITEM NO. F 22 SB 00TRAY 08 01

Steel tray with 17 compartments:
 2 "grey" inset boxes with dividers
 3 "yellow" inset boxes
 6 "blue" inset boxes

ITEM NO. F 22 SB 00TRAY 09 01

Steel tray with 14 compartments:
 2 "grey" inset boxes with dividers
 3 "blue" inset boxes
 3 "green" inset boxes

ITEM NO. F 22 SB 00TRAY 10 01

Steel tray with:
 2 "grey" inset boxes with dividers
 2 store box mini63

ITEM NO. F 22 SB 00TRAY 11 01

Steel tray with:
 1 "dark" thermo-formed insert with 5 compartments

ITEM NO. F 22 SB 00TRAY 12 01

Steel tray with:
 1 "dark" thermo-formed insert with 12 compartments



STORE BOXDIVIDER

ITEM NO. F 22 SB 000RED 63 03

"Red" inset box W=52 D=52 H=63

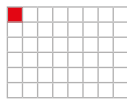

BOX067
BOX080

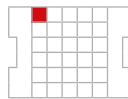

BOX102
BOXTRAY

ITEM NO. F 22 SB YELLOW 63 05

"Yellow" inset box W=52 D=104 H=63

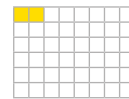

BOX067
BOX080

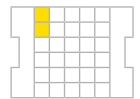

BOX102
BOXTRAY

ITEM NO. F 22 SB 00BLUE 63 16

"Blue" inset box W=104 D=104 H=63

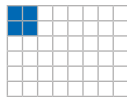

BOX067
BOX080

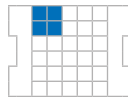

BOX102
BOXTRAY

ITEM NO. F 22 SB 0GREEN 63 14

"Green" inset box W=104 D=156 H=63

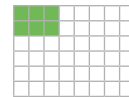

BOX067
BOX080

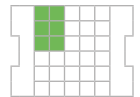

BOX102
BOXTRAY

ITEM NO. F 22 SB FOREST 63 09

"Forest" inset box W=104 D=312 H=63

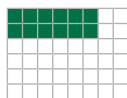

BOX067
BOX080

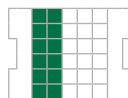

BOX102
BOXTRAY

ITEM NO. F 22 SB MINI63 63 08

Store Box Mini63 W=260 D=155 H=63

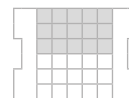

BOX102
BOXTRAY



ITEM NO. F 22 SB 00GREY 63 01

"Grey" inset box W=71 D=312 H=63

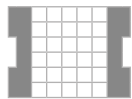

BOX102
BOXTRAY

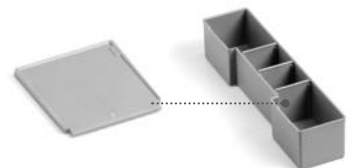

ITEM NO. F 22 SB DVGREY 58 01

Divider for "grey" inset box W=52 D=4 H=58



ITEM NO. F 22 SB DARK05 62 07

"Dark" thermo-formed insert with 5 compartments - W=405 D=315 H=62



BOX102
BOXTRAY



ITEM NO. F 22 SB DARK12 62 07

"Dark" thermo-formed insert with 12 compartments - W=405 D=315 H=62



BOX102
BOXTRAY



STORE ROLL

ITEM NO. F 22 SB 00ROLL 00 08

Trolley for cases BOX102 - 136 - 238 - 374
with two castor wheels with brake and two standard castors
Load capacity 100 kg
W=650 D=510 H=150 mm





STORE CADDY

ITEM NO. F 22 SB 0CADDY 00 00

Fold-away trolley in aluminium
Load capacity 80 kg
Open dimensions W=490 D=490 H=1090 mm
Closed dimensions W=490 D=60 H=760 mm



WWW.STOREVAN.COM



FAMI S.r.l.

Via Stazione Rossano, 13 | 36027 Rosà (VI) | ITALY
phone +39 0424 585455 | fax +39 0424 585482
www.famispaspa.com | info@famispaspa.com
www.storevan.com | info@storevan.com