



BEDRIJFSWAGENINRICHTINGEN
FITTINGS FOR COMMERCIAL VEHICLES



RENAULT MASTER





TECHNOLOGIE

GEALVANISEERD STAAL

Het product wordt onder verhitting tot ca. 550 °C voorzien van een zinklaag. Daardoor ontstaat er een legering tussen blik en zink. Dat resulteert in een laag met een evenwichtige, fijne kristalstructuur en een **zeer hoge oppervlakte kwaliteit en corrosiebestendigheid**. Dit procedé is ideaal voor automotieve toepassingen. StoreVan heeft deze techniek nu ook voor haar bedrijfswageninrichtingen geïmplementeerd.

HET PROCES VAN HET KATHODISCHE ACRYL DOMPELBAD VERFSYSTEEM

De kathodische Acryl-afwerking is een oppervlakte behandeling, die de diverse onderdelen van de inrichting een **extreem hoge corrosiebestendigheid** bezorgt. De dompelbad techniek, die ook in de auto-industrie wordt toegepast, garandeert een **gelijkmatige laagdikte** en een langdurige bescherming tegen alle mogelijke stoffen. De Acrylhars beschermt de lak tegen uitbleken door weersinvloeden en is slagvast en daarmee blijvend corrosiebestendig.

- Corrosiebestendigheid meer dan 500 uur (ASTM D1735 luchtvochtigheid)
- Uitstekende hardheid met tenminste een rating van 2H



StoreVan is wereldwijd de enige fabrikant van bedrijfswageninrichtingen, die met deze technologie werkt.

StoreVan is the sole LCV's equipment manufacturer worldwide to make use of this technology.



STORE VAN ORANGE PLANET

Duurzaamheid en ecologische ontwikkelingen zijn thema's van groot, actueel belang, ontstaan door het toenemende bewustzijn, dat het milieu door cyclische veranderingen en vernieuwingen in balans moet blijven.

STORE VAN ORANGE PLANET

Environmental sustainability and eco-compatible development are topics of great interest and relevance, arising from the growing awareness that it is important to pay attention to the environmental balance.

TECHNOLOGIES

GALVANNEALED STEEL

Galvannealed sheet is a variant of hot-dip galvanized sheet. The product is subject to a hot-dip galvanization process and subsequently heated to approximately 550°C, combining the zinc with the sheet surface to make an alloy with iron. The result is a uniform zinc coating with a fine-grained crystalline structure along with a **much higher surface quality and corrosion resistance**. This process is ideal for automotive applications. StoreVan has introduced and implemented this technology in the commercial vehicles equipment field.

CATHODIC DIP PAINTING WITH ACRYLIC RESIN

Cataphoresis painting is a paint surface treatment able to give the equipment elements a **remarkable resistance to corrosion**; characterized by **uniform deposit** of an acrylic resin on the element surface, it ensures long lasting, high protection against chemical agents and other types of surface attacks. The acrylic resin allows a direct exposure to atmospheric agents without altering its technical features. This process ensures an increased protection against rust.

- Corrosion resistance of more than 500 hours (humidity ASTM D1735)
- Excellent hardness with a minimum rating of 2H



FLEXIBEL BEVESTIGINGSSYSTEEM

FLEXIBLE FIXING SYSTEM

FLEXIBILITEIT EN DUURZAAMHEID VAN STOREVAN MATERIAAL

StoreVan maakt gebruik van een speciaal bevestigingssysteem om modules voor bedrijfswagens aan het chassis van het voertuig te bevestigen. Daardoor wordt de flexibiliteit van de module-opstelling verbeterd. De zijwanden van de modules hebben een tweevoudige functie: zij verbinden schap-eenheden op uniforme wijze met de carrosserie van het voertuig én verdelen gelijkmatig alle dynamische krachten in uw bedrijfswagen, die tijdens het rijden optreden.

Speciale trillingsdempende verbindingsbeugels absorberen de torsiekrachten die door het chassis worden veroorzaakt, vooral in bochten. Dankzij dit systeem kunnen onze bevestigingen voor bedrijfswagens overal worden toegepast, waarbij hoge veiligheids-, stabiliteits- en duurzaamheidsnormen altijd worden gegarandeerd.

FLEXIBILITY AND DURABILITY OF STORE VAN EQUIPMENT

Store Van uses a special rail anchoring system to secure shelving units for vans to the chassis of your vehicle, improving the flexibility of module arrangement and maximising the internal spaces of your van.

This system is based on brackets sliding all along the rail rather than being riveted to chassis reinforcements, thus offering great flexibility in the management of internal spaces. The Store Van rail is secured to the uprights of your mobile workshop and has a two-fold function: it connects shelving units uniformly to the frame of your vehicle, and it evenly distributes all the dynamic forces your van equipment is subject to while travelling.

Special vibration damping joints, fitted on the brackets connecting the rail to the module, absorb the torsional vibration applied on the chassis especially when driving on a curve.

Thanks to this system, our fittings for vans can be designed with maximum freedom, always ensuring high safety, stability and durability standards.

Onze verankeringsystemen zijn uitgerust met snel-verbindingen, zodat u als gebruiker de modules kunt verwijderen zonder gereedschap. Vandaar dat de modules van uw mobiele werkplaats kunnen worden beschouwd als vervoerde goederen of ladingbevestigingshulpstukken die niet permanent aan het voertuig zijn bevestigd, in overeenstemming met Richtlijn 2014/47EU, hoofdstuk 1, artikel 3, item 5.

Our anchoring systems are fitted with quick locking/unlocking devices with adjustable handles, so users can remove the fittings with no need of tools. Hence the shelving units of your mobile workshop may be considered as transported goods or load securing fittings not permanently fixed to the vehicle, in compliance with Directive 2014/47EU, Chapter 1, Article 3, Item 5.



CERTIFICERINGEN CERTIFICATIONS

GECERTIFICEERDE PRODUCTIE

- ISO 9001: 2015 gecertificeerd.
- Succesvolle CRASH TEST volgens ECE-R17 met een snelheid van 50 km/u.
- GS-Certificaat voor de laadplatforms en inrichtingen.
- GS-Certificaat voor imperiaal en ladderdrager.

CERTIFIED PRODUCTION

- ISO 9001:2015 certified.
- Brilliantly passed the CRASH TEST carried out according to the most recent European regulations ECE-R17 with impact at 50 Km/h.
- GS certification for interior fittings and loading ramps.
- GS certification for roof and ladder racks.

CRASH TEST
ECE-R17



De basis voor de veilige bescherming van voertuigen

The basis for the safe
protection of vehicles

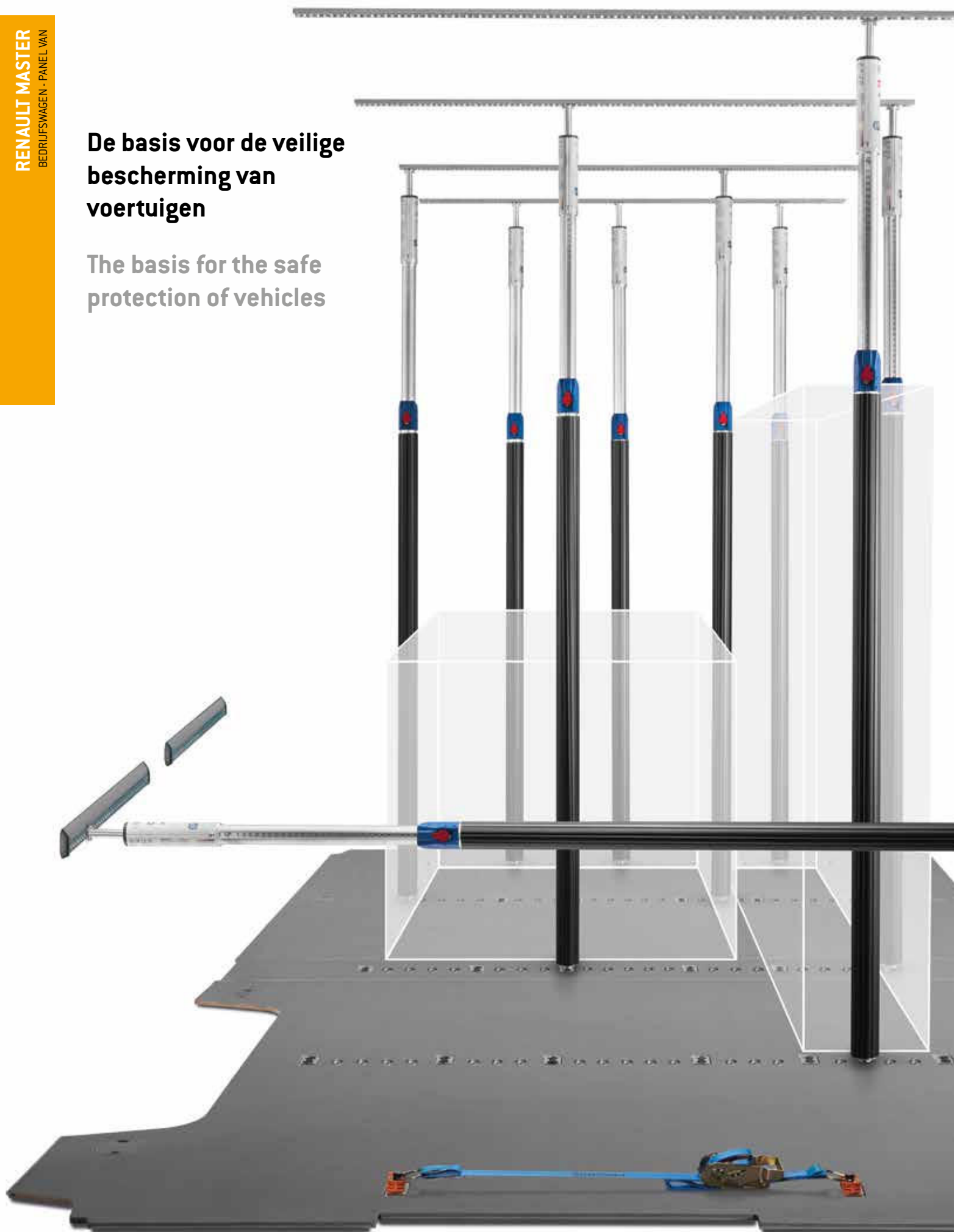

De invoering van Richtlijn 2014/47/EU zal de controle op voertuigen van de categorie N2 en N3 en de handhaving van de ladingbeveiligingssystemen intensiveren. Krachtens deze richtlijn kunnen de lidstaten voertuigen die buiten het toepassingsgebied van de richtlijn vallen, zoals voertuigen van de categorie N1, onderwerpen aan technische inspecties.

LADINGBEVEILIGING EN LADINGZEKERING

Het nieuwe geïntegreerde systeem van StoreVan volgt de richtlijnen van Richtlijn 2014/47/EU, terwijl de **verankering van de lading aan de vloer en wanden van de bedrijfswagen flexibel en veilig is.**

Met de toepassing van 'Airline' bevestigingscomponenten en gebruik van veel verschillende accessoires, zoals sjoorbanden, netten en telescopische laadbeugels, kunnen eindgebruikers hun laadruimte gemakkelijk en goedkoop configureren.

Het systeem gebruikt:

- Multiplex watervast verlijmd vloerplaten met speciale phenol coating, geschikt voor de reeds bestaande sjoorog bevestigingen en met extra 200 daN sterke verzonken bevestigingspunten (pagina 10);
- Aluminium 'Airline' rails verankerd aan het chassis (pagina 11);
- Zeer flexibele en sterke polypropyleen honingraat panelen om de binnenzijde van de laadruimte te beschermen tegen onbedoelde beschadigingen (pagina 8).

VOORDELEN VAN HET NIEUWE LAADBEVEILIGINGSSYSTEEM:

- Gebruikers kunnen de lading veilig met sjoorbanden aan de 'Airline'-rails bevestigen;
- Door het geïntegreerde ladingbeveiligingssysteem houdt men de laadruimte langer netjes;
- Zowel nieuwe als oudere voertuigen behouden langer hun waarde, doordat de laadruimte minder beschadigingen oploopt tijdens het gebruik.

Transposition of directive 2014/47/EU will intensify control of N2 and N3 category transport vehicles and cargo securement enforcement. Under this Directive, the Member States can subject vehicles that are beyond the scope of the Directive, such as N1 category vehicles, to technical inspections, and also monitor other transport and road safety aspects.

CARGO AREA PROTECTION SYSTEM AND CARGO RESTRAINT

The new Store Van integrated system for van protection follows the guidelines of Directive 2014/47/EU while making the **anchoring of the cargo to the van floor and walls flexible and safe.**

With the use of "Airline" securing components and integration of many different accessories such as belts, nets and telescopic load restraining bars, final users may configure their cargo platform easily and cheaply and in conformity with the European Directive.

The system uses:

- phenolic resin plywood floor panels, arranged to fit original anchoring fittings and additional 200 daN strength lashing points (page 10), flush with the floor panel;
- aluminium "Airline" bars anchored to the chassis (page 11);
- highly flexible and resistant polypropylene panelling to protect the internal body shell from accidental impacts (page 8).

THE NEW LOAD SECURING SYSTEM OFFERS NUMEROUS ADVANTAGES:

- users can safely secure the load to the "Airline" bars with load restraining belts;
- the integrated load securing system extends the body's good condition over the time;
- the protection system offers new added value, an important economic aspect for a new vehicle and a fundamental characteristic for a second-hand vehicle, that is usually exposed to damage.

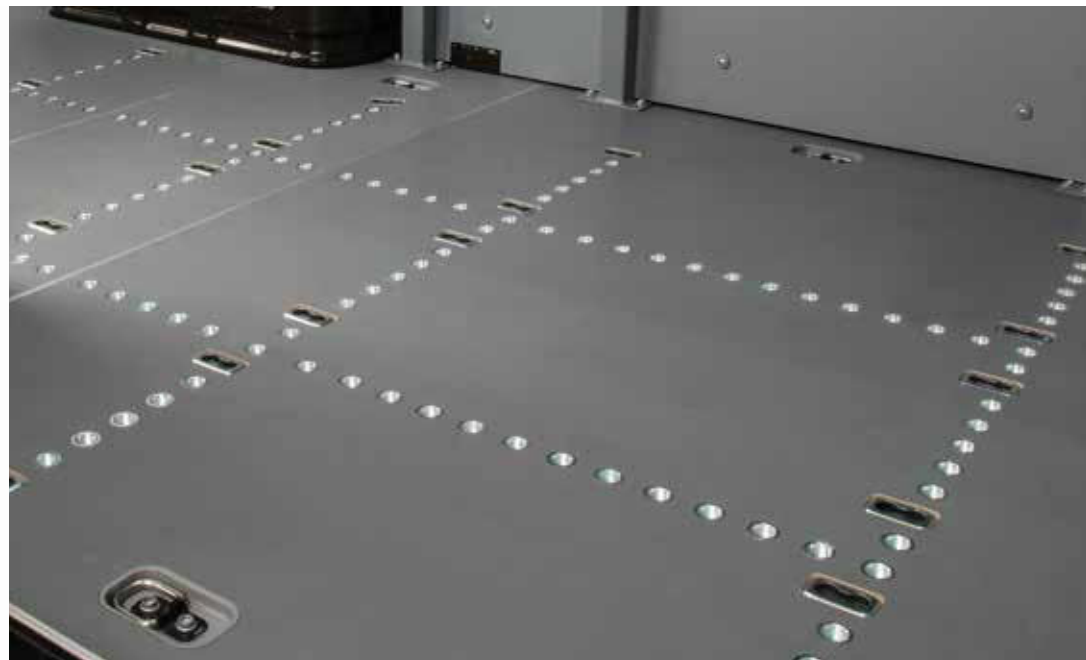

SAFETY CROSS: Bevestigingspunten in lengterichting en dwarsrichting op aanvraag.
SAFETY CROSS: longitudinal and transversal fixing points upon request.



- Zijwandbekledingen voor een voertuig met rechter schuifdeur en stalen zijwanden.
- Linings for right side door vehicle with metal sheet sidewalls.

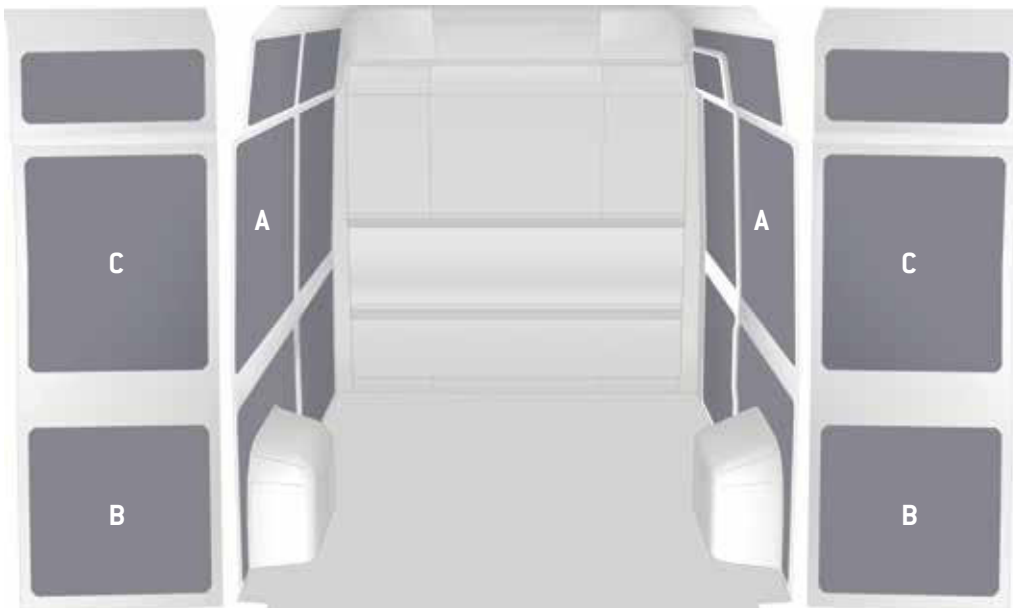

HONEYCOMB PANEL - A

- Wandbekleding uit polypropyleen voor:
 - linker zijwand
 - rechter zijwand en schuifdeur
- Polypropylene linings for:
 - LH sidewall
 - RH sidewall and sliding door

HONEYCOMB PANEL - B

- Wandbekleding uit polypropyleen voor:
 - onderste deel achterdeuren
- Polypropylene linings for:
 - lower part of rear hinged doors

HONEYCOMB PANEL - C

- Wandbekleding uit polypropyleen voor:
 - bovenste deel achterdeuren
- Polypropylene linings for:
 - upper part of rear hinged doors

VOERTUIG VEHICLE	WANDBEKLEDING LINING	
	A+B	C
	ART. NR. / ITEM NO.	ART. NR. / ITEM NO.
Voertuigtype - Model L1 H1 ^A	MA 10H1 A0 13,00 kg	MA DRH1 A0 2,13 kg
Voertuigtype - Model L1 H2 ^A	MA 10H2 A0 14,39 kg	MA DRH2 A0 2,65 kg
Voertuigtype - Model L2 H2/H3 ^A	MA 20H2 A0 17,91 kg	MA DRH2 A0 2,65 kg
Voertuigtype - Model L3 H2/H3 ^A	MA 30H2 A0 20,24 kg	MA DRH2 A0 2,65 kg
Voertuigtype - Model L3 H2/H3 ^B	MA 2LH2 JO 19,54 kg	MA DRH2 A0 2,65 kg
Voertuigtype - Model L3 H2/H3 ^C	MA 2LH2 JO 19,54 kg	MA DRH2 A0 2,65 kg
Voertuigtype - Model L4 H2/H3 ^B	MA 3LH2 JO 27,08 kg	MA DRH2 A0 2,65 kg
Voertuigtype - Model L4 H2/H3 ^C	MA 3LH2 JO 27,08 kg	MA DRH2 A0 2,65 kg

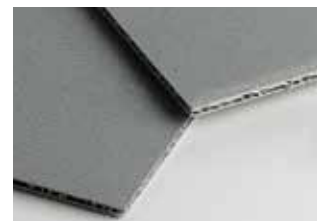

^A Voorwielaandrijving, enkele wielen
Front-wheel drive, single wheels

^B Achterwielaandrijving, enkele wielen
Rear-wheel drive, single wheels

^C Achterwielaandrijving, dubbele wielen
Rear-wheel drive, twin wheels



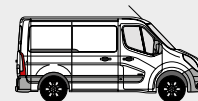

- Bodemplaat voor een voertuig met rechter schuifdeur en stalen zijwanden.
- Flooring for right side door vehicle with metal sheet sidewalls.



WOOD FLOOR - D

- Bodemplaat uit multiplex met phenolbekleding, dikte 9/12 mm, vorgeboord voor bevestiging d.m.v. de bestaande sjoorogen
- 9/12 mm thick wooden flooring with phenolic coating set for the vehicle original anchoring system

WOOD FLOOR - F

- Cabineshotplaat uit multiplex met phenolbekleding, dikte 12 mm
- 12 mm thick wooden bulkhead panel with phenolic coating

VOERTUIG VEHICLE	BODEMPLAAT 9 mm 9 mm FLOORING	BODEMPLAAT 12 mm 12 mm FLOORING	CABINESHOTPLAAT BULKHEAD
	D	D	F [1590x740x12 mm]
	ART. NR. / ITEM NO.	ART. NR. / ITEM NO.	ART. NR. / ITEM NO.
Voertuigtype - Model L1 ^A	MA 10D1 AO 27,83 kg	MA 10T1 AO 34,75 kg	MA WBT1 AO 9,79 kg
Voertuigtype - Model L2 ^A	MA 20D1 AO 33,88 kg	MA 20T1 AO 42,24 kg	MA WBT1 AO 9,79 kg
Voertuigtype - Model L3 ^A	MA 30D1 AO 41,94 kg	MA 30T1 AO 52,21 kg	MA WBT1 AO 9,79 kg
Voertuigtype - Model L3 ^B	MA 2LD1 JO 40,16 kg	MA 2LT1 JO 49,98 kg	MA WBT1 AO 9,79 kg
Voertuigtype - Model L3 ^C	MA 2LD1 SO 38,38 kg	MA 2LT1 SO 47,78 kg	MA WBT1 AO 9,79 kg
Voertuigtype - Model L4 ^B	MA 3LD1 JO 45,85 kg	MA 3LT1 JO 57,19 kg	MA WBT1 AO 9,79 kg
Voertuigtype - Model L4 ^C	MA 3LD1 SO 45,73 kg	MA 3LT1 SO 57,09 kg	MA WBT1 AO 9,79 kg



^A Voorwielaandrijving, enkele wielen - Front-wheel drive, single wheels
^B Achterwielaandrijving, enkele wielen - Rear-wheel drive, single wheels
^C Achterwielaandrijving, dubbele wielen - Rear-wheel drive, twin wheels





- Bodemplaat voor een voertuig met rechter schuifdeur en stalen zijwanden.
- Flooring for right side door vehicle with metal sheet sidewalls.

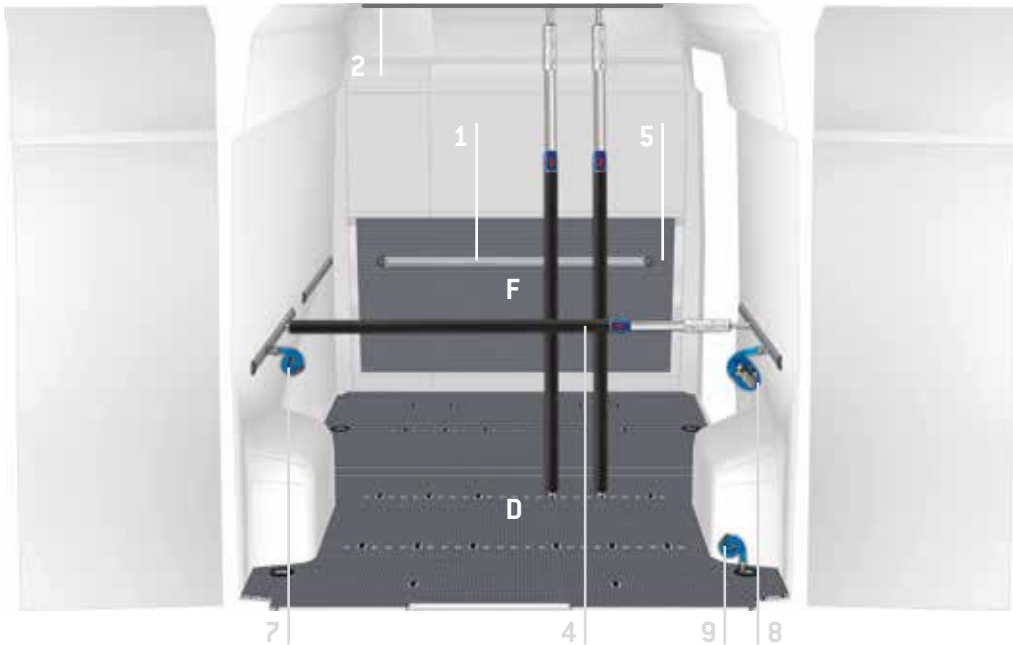

SAFETY FLOOR - D

- Bodemplaat uit multiplex phenolbekleding, dikte 9 mm, met extra sjoerpunten
- 9 mm phenol faced plywood flooring with additional lashing points

WOOD FLOOR - F

- Cabineshotplaat, dikte 12 mm, met phenolbekleding
- 12 mm thick wooden bulkhead panel with phenolic coating

VOERTUIG VEHICLE	BODEMPLAAT 9 mm FLOORING 9 mm	CABINESCHOTPLAAT BULKHEAD
	D	F (1590x740x12 mm)
	ART. NR. / ITEM NO.	ART. NR. / ITEM NO.
Voertuigtype - Model L1 ^A	MA 10G1 A0 31,44 kg	MA WBT1 A0 9,79 kg
Voertuigtype - Model L2 ^A	MA 20G1 A0 37,47 kg	MA WBT1 A0 9,79 kg
Voertuigtype - Model L3 ^A	MA 30G1 A0 46,45 kg	MA WBT1 A0 9,79 kg
Voertuigtype - Model L3 ^B	MA 2LG1 J0 42,66 kg	MA WBT1 A0 9,79 kg
Voertuigtype - Model L3 ^C	MA 2LG1 S0 42,56 kg	MA WBT1 A0 9,79 kg

^A Voorwielaandrijving, enkele wielen - Front-wheel drive, single wheels
^B Achterwielaandrijving, enkele wielen - Rear-wheel drive, single wheels
^C Achterwielaandrijving, dubbele wielen - Rear-wheel drive, twin wheels

⚠ De vloer dient aan het voertuig te worden gelijmd.
 The floor must be glued to the vehicle

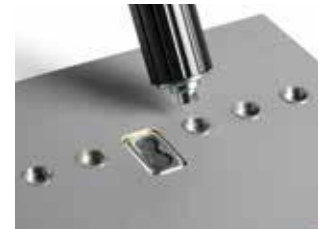

- Siliconenlijm voor vloeren.
- Silicone glue for flooring.

ART. NR. / ITEM NO. **V22585**

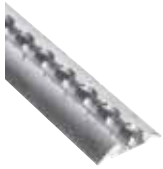

- Horizontale aluminium rail.
- Horizontal aluminium bar.

1

ART. NR. / ITEM NO.

- V18029 05 Lengte - Length 500 mm
- V18029 10 Lengte - Length 1000 mm
- V18029 15 Lengte - Length 1500 mm
- V18029 20 Lengte - Length 2000 mm
- V18029 25 Lengte - Length 2500 mm



- Telescopische spanstang.
- Telescopic load restraining bar.

4

ART. NR. / ITEM NO.

- V22149 Lengte - Length 650-900 mm
- V22734 Lengte - Length 850-1100 mm
- V22735 Lengte - Length 1050-1300 mm
- V22131 Lengte - Length 1250-1750 mm
- V22017 Lengte - Length 1550-2050 mm
- V22086 Lengte - Length 2000-2500 mm



- Eindstop voor rail serie V18029.
- Plastic end cap for bar series V18029.

5

ART. NR. / ITEM NO.

V22106



- Horizontale aluminium rail.
- Horizontal aluminium bar.

2

ART. NR. / ITEM NO.

- V18025 05 Lengte - Length 500 mm
- V18025 10 Lengte - Length 1000 mm
- V18025 15 Lengte - Length 1500 mm
- V18025 20 Lengte - Length 2000 mm



- Trekoog.
- Ring stud fitting.

6

ART. NR. / ITEM NO.

V225820



- Sjorband met snapsluiting 2500+500.
- Load restraining belt with clamp 2500+500.

7

ART. NR. / ITEM NO.

V22136



- Eindstop voor rail serie V18025.
- Plastic end cap for bar series V18025.

10

ART. NR. / ITEM NO.

V23389



- Horizontale aluminium rail.
- Horizontal aluminium bar.

3

ART. NR. / ITEM NO.

- V18030 10 Lengte - Length 1000 mm
- V18030 15 Lengte - Length 1500 mm
- V18030 20 Lengte - Length 2000 mm
- V18030 25 Lengte - Length 2500 mm
- V18030 30 Lengte - Length 3000 mm



- Sjorband met ratel 2500+500.
- Load restraining belt with ratchet 2500+500.

8

ART. NR. / ITEM NO.

V22124



- Sjorband met ratel 4500+500.
- Load restraining belt with ratchet 4500+500.

9

ART. NR. / ITEM NO.

V22148



- Voorbeeld van gereedschapskoffer met ladingzekering.
- Example of tool case for load securing.



1 ART. NR. / ITEM NO.
BOX080

B=440 T=350 H=80 mm
W=440 D=350 H=80 mm



2 ART. NR. / ITEM NO.
V22136



1 ART. NR. / ITEM NO.
CPV080



2 ART. NR. / ITEM NO.
V22124



4 ART. NR. / ITEM NO.
V225820



2 ART. NR. / ITEM NO.
V22148



1 ART. NR. / ITEM NO.
YELLOW



ONDERDELEN WANDBEKLEDING - LININGS LEGEND

RENAULT MASTER
BEDRIJFSWAGEN - PANEL VAN

HP HONEYCOMB
PANEL

- Voor een voertuig met rechter schuifdeur en stalen zijwanden.
- For right side door vehicle with metal sheet sidewalls.

Voertuigtype - Model
L1 H1^A

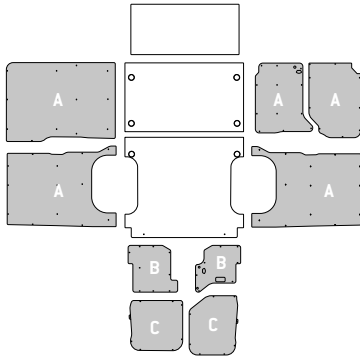

Voertuigtype - Model
L1 H2^A

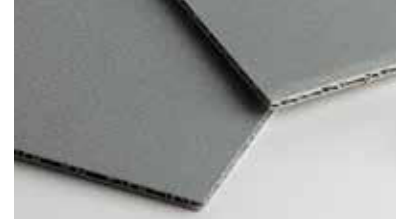
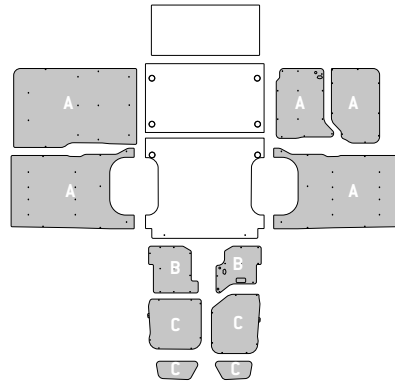

- A** Voorwielaandrijving, enkele wielen
Front-wheel drive, single wheels
- B** Achterwielaandrijving, enkele wielen
Rear-wheel drive, single wheels
- C** Achterwielaandrijving, dubbele wielen
Rear-wheel drive, twin wheels

Voertuigtype - Model
L2 H2/H3^A

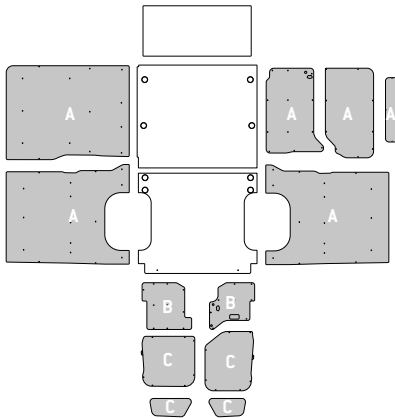

Voertuigtype - Model
L3 H2/H3^A

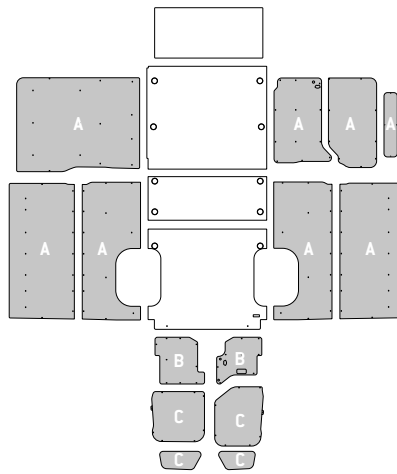

Voertuigtype - Model
L3 H2/H3^B

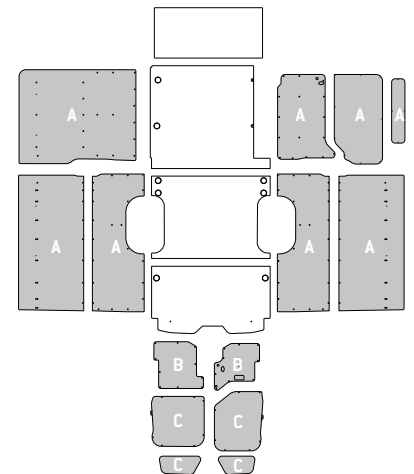

Voertuigtype - Model
L3 H2/H3^C

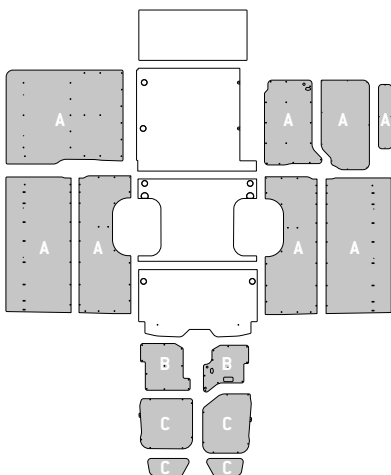

Voertuigtype - Model
L4 H2/H3^B

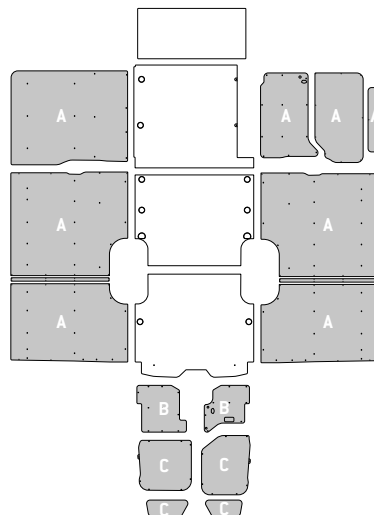

Voertuigtype - Model
L4 H2/H3^C

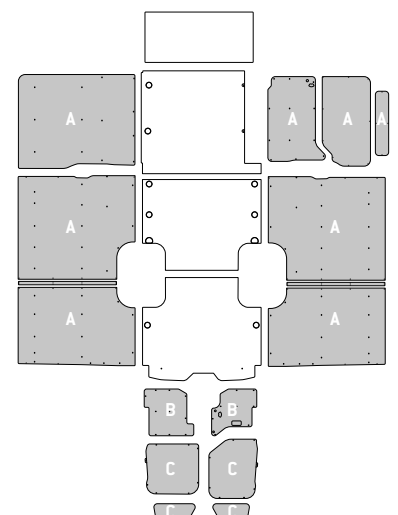



**Standaard met
ladingzekering**

Factory-fitted load
securing



De StoreVan **veilige bedrijfswageninrichtingen** voldoen aan de eisen van de nieuwste ladingbeveiligingsvoorschriften. In de module worden elementen gemonteerd die gebruik van bevestigingssystemen, zoals spanbanden, netten en telescopische spanstangen, mogelijk maken. Dit nieuwe niveau **van inrichtingen voor bedrijfswagens** vergemakkelijkt het verankeren van middelgrote en kleine voorwerpen. Zelfs wanneer de bodemplaat niet met bevestigingssystemen is uitgerust, garandeert het ladingszekeringsstelsel veiligheid zonder gewichtstoename van de module, doordat dit in de inrichting is geïntegreerd.

The Store Van **SAFETY equipment solution** meets the requirements of the new cargo restraint regulations. Our modules are integrated with structural elements where "Airline" anchoring fittings, such as belts, nets and telescopic bars can easily fit. This new equipment for commercial vehicles simplifies the securing of medium-sized or small parts, even if the floor panel of your van has no anchoring systems, to guarantee maximum load securing. The "Airline" anchoring fittings for SAFETY equipment improve the stability of modules with no weight increase, because they are built in the equipment structure.





INRICHTINGSVOORBEELDEN - FITTINGS EXAMPLES

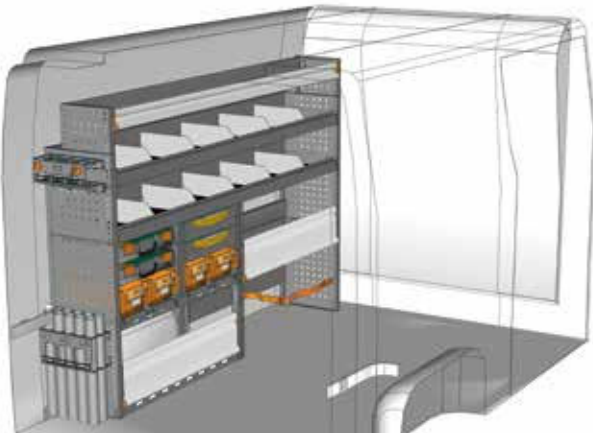

VOORBEELD - EXAMPLE

MA 2014 01*

B=2032 T=365 H=1400 mm - W=2032 D=365 H=1400 mm

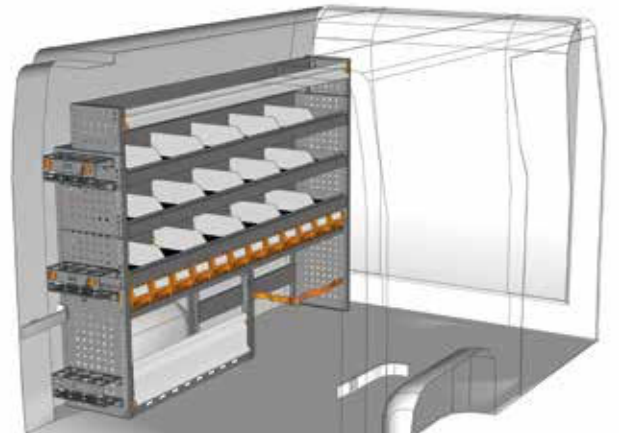
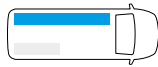

VOORBEELD - EXAMPLE

MA 2014 02*

B=2032 T=365 H=1400 mm - W=2032 D=365 H=1400 mm

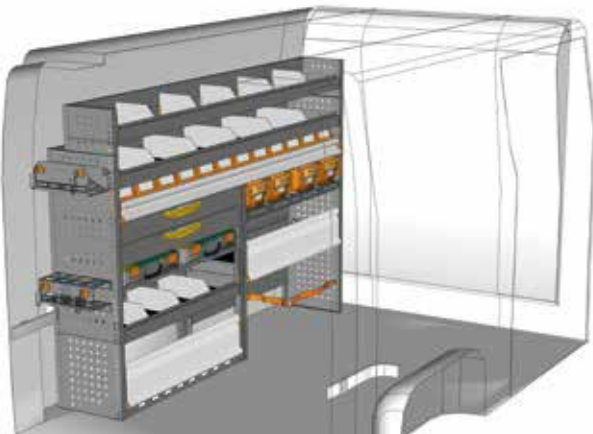

VOORBEELD - EXAMPLE

MA 2014 03*

B=2032 T=365 H=1400 mm - W=2032 D=365 H=1400 mm

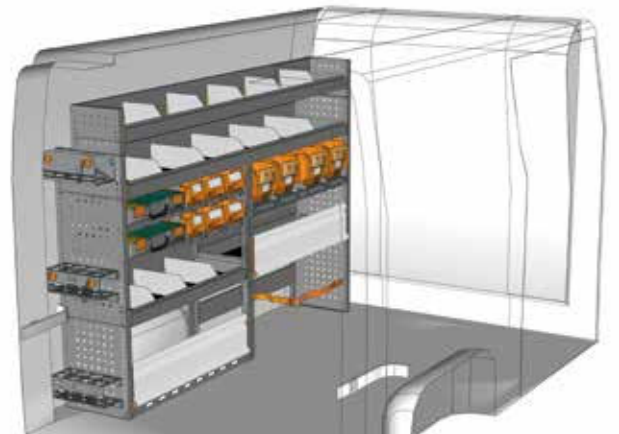
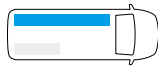

VOORBEELD - EXAMPLE

MA 2014 04*

B=2032 T=365 H=1400 mm - W=2032 D=365 H=1400 mm

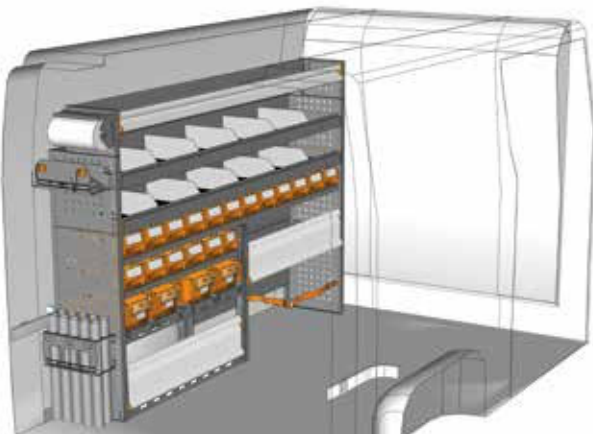

VOORBEELD - EXAMPLE

MA 2014 06*

B=2032 T=365 H=1400 mm - W=2032 D=365 H=1400 mm

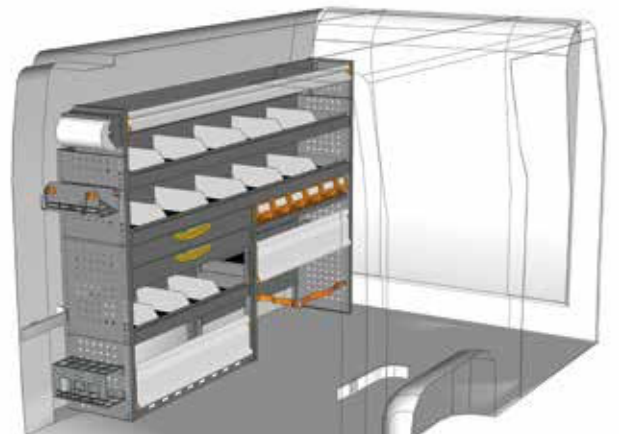
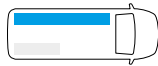

VOORBEELD - EXAMPLE

MA 2014 07*

B=2032 T=365 H=1400 mm - W=2032 D=365 H=1400 mm



* Inclusief bevestigingsmateriaal - Fixing kit included



INRICHTINGSVOORBEELDEN - FITTINGS EXAMPLES

BEDRIJFSWAGEN - PANEL VAN
RENAULT MASTER

SAFETY

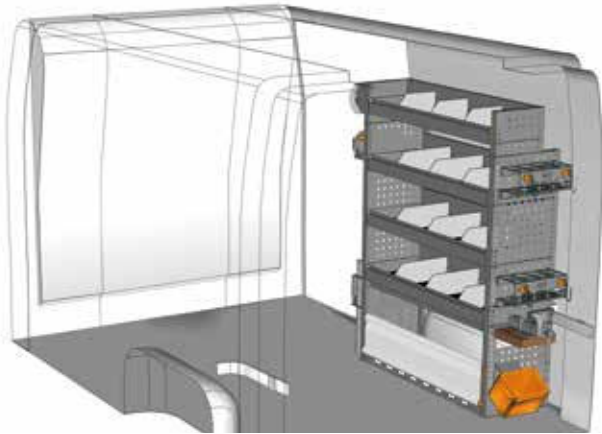

VOORBEELD - EXAMPLE

MA 1014 01*

B=1016 T=365 H=1400 mm - W=1016 D=365 H=1400 mm

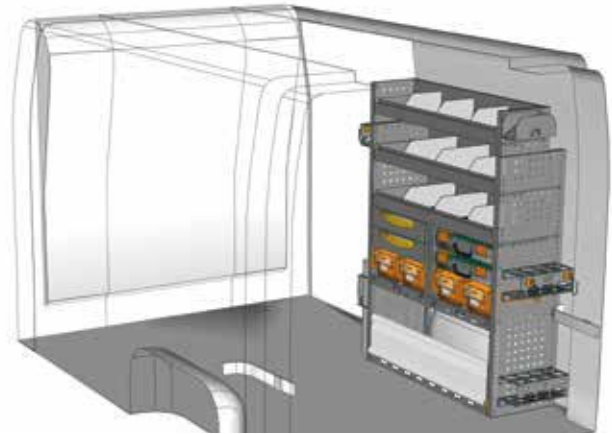
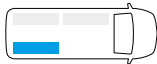

VOORBEELD - EXAMPLE

MA 1014 02*

B=1016 T=365 H=1400 mm - W=1016 D=365 H=1400 mm

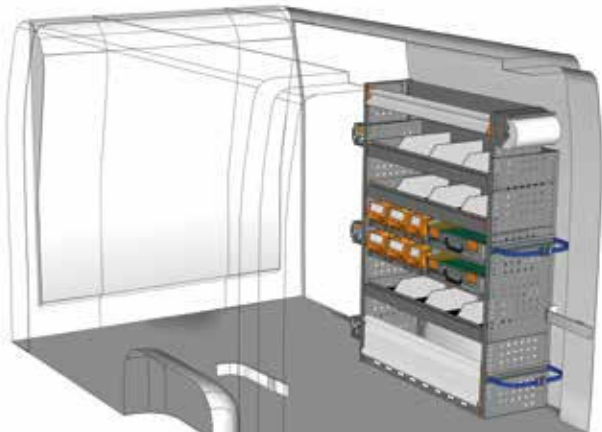
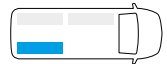

VOORBEELD - EXAMPLE

MA 1014 05*

B=1016 T=365 H=1400 mm - W=1016 D=365 H=1400 mm

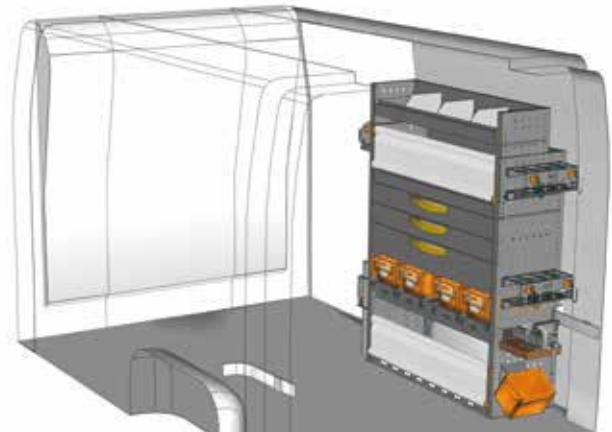
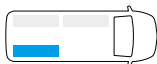

VOORBEELD - EXAMPLE

MA 1014 09*

B=1016 T=365 H=1400 mm - W=1016 D=365 H=1400 mm

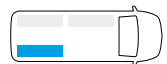

Aanzicht vanuit de schuifdeur
View from side door

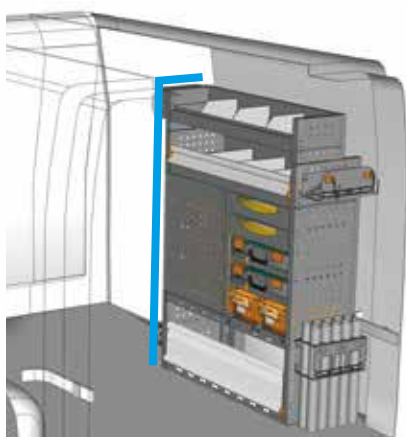

VOORBEELD - EXAMPLE

MA 1014 10*

B=1016 T=365 H=1400 mm - W=1016 D=365 H=1400 mm

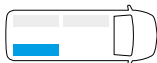

Heeft u uw ideale inrichting niet gevonden?
Voor bedrijfswageninrichtingen op maat neemt u contact op met onze vakmensen.
Op de achterzijde vindt u de adresgegevens of bezoek onze website www.storevannederland.nl

Didn't find the equipment you're looking for?
Leave it to our experts.
See the back of this catalogue and contact the nearest StoreVan point or visit our website.



* Inclusief bevestigingsmateriaal - Fixing kit included

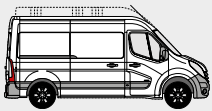

INRICHTINGSVOORBEELDEN - FITTINGS EXAMPLES

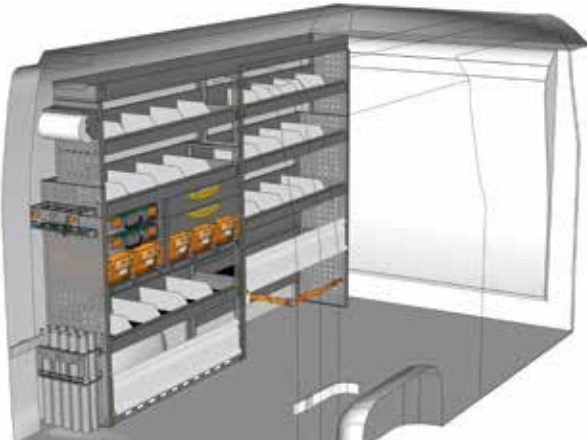

VOORBEELD - EXAMPLE

MA 2417 01*

B=2450 T=365 H=1690 mm - W=2450 D=365 H=1690 mm

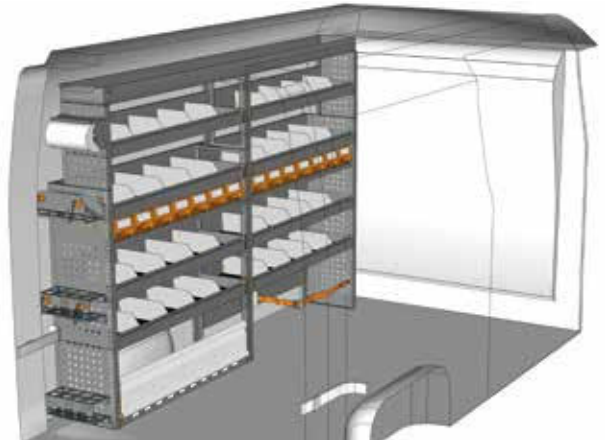
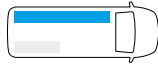

VOORBEELD - EXAMPLE

MA 2417 02*

B=2450 T=365 H=1690 mm - W=2450 D=365 H=1690 mm

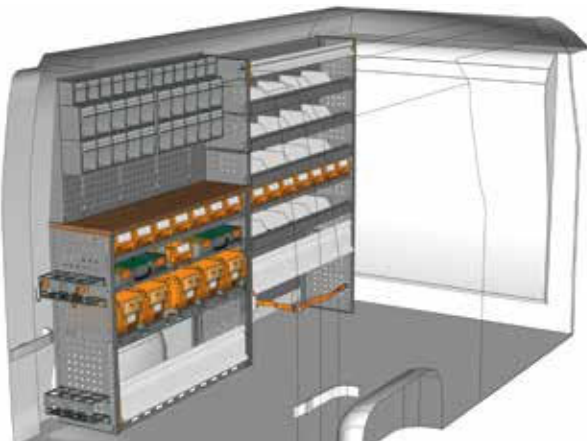
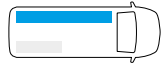

VOORBEELD - EXAMPLE

MA 2417 03*

B=2450 T=365 H=1725 mm - W=2450 D=365 H=1725 mm

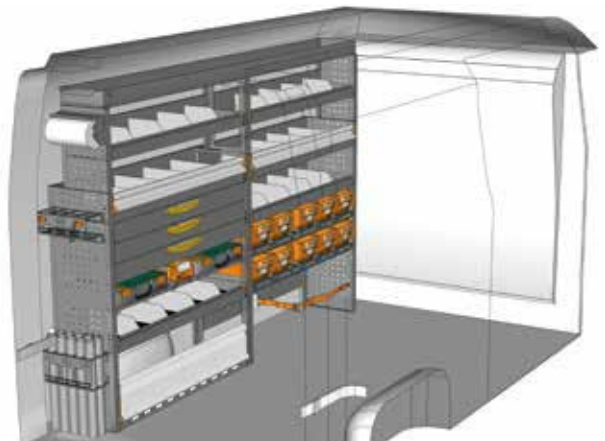
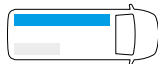

VOORBEELD - EXAMPLE

MA 2417 04*

B=2450 T=365 H=1690 mm - W=2450 D=365 H=1690 mm

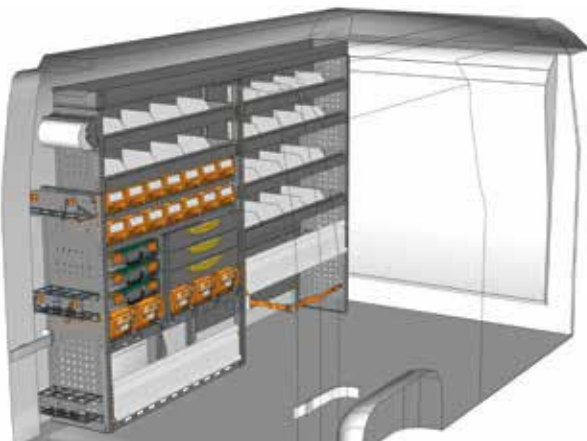
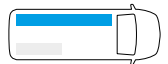

VOORBEELD - EXAMPLE

MA 2417 05*

B=2450 T=365 H=1690 mm - W=2450 D=365 H=1690 mm

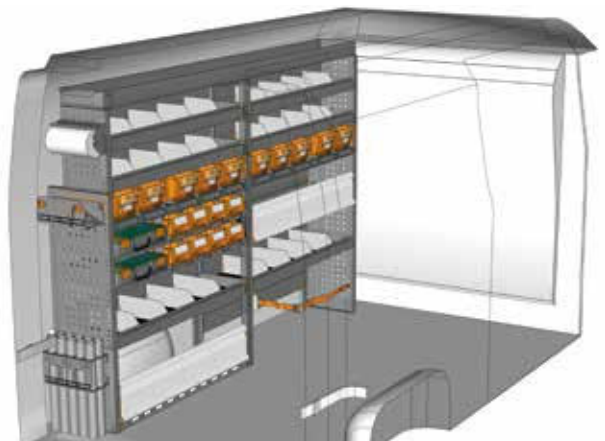
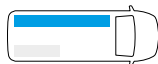

VOORBEELD - EXAMPLE

MA 2417 06*

B=2450 T=365 H=1690 mm - W=2450 D=365 H=1690 mm

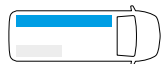

* Inclusief bevestigingsmateriaal - Fixing kit included

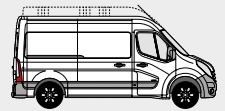

INRICHTINGSVOORBEELDEN - FITTINGS EXAMPLES



VOORBEELD - EXAMPLE

MA 1217 01*

B=1225 T=365 H=1700 mm - W=1225 D=365 H=1700 mm

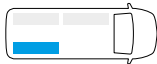

Aanzicht vanuit de schuifdeur
View from side door



VOORBEELD - EXAMPLE

MA 1217 02*

B=1225 T=365 H=1700 mm - W=1225 D=365 H=1700 mm

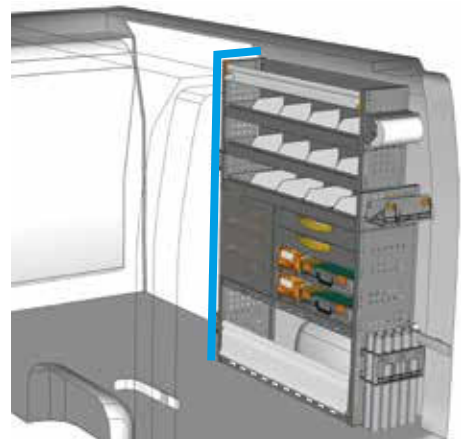
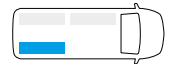

VOORBEELD - EXAMPLE

MA 1217 05*

B=1225 T=365 H=1700 mm - W=1225 D=365 H=1700 mm

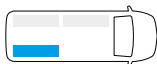

VOORBEELD - EXAMPLE

MA 1217 07*

B=1225 T=365 H=1700 mm - W=1225 D=365 H=1700 mm

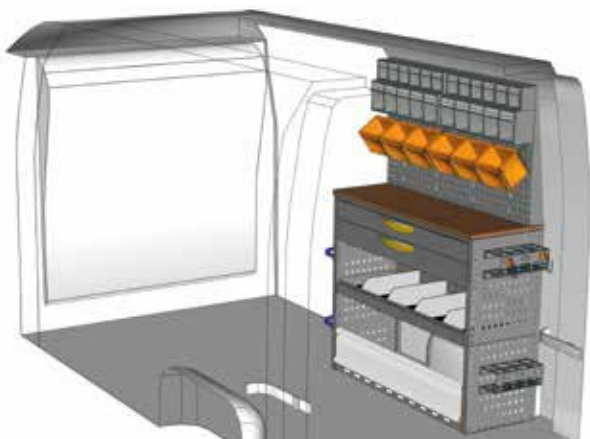
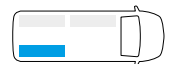

VOORBEELD - EXAMPLE

MA 1217 10*

B=1225 T=445 H=1725 mm - W=1225 D=445 H=1725 mm

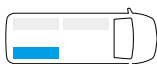

Heeft u uw ideale inrichting niet gevonden?
Voor bedrijfswageninrichtingen op maat neemt u contact op met onze vakmensen.
Op de achterzijde vindt u de adresgegevens of bezoek onze website www.storevannederland.nl

Didn't find the equipment you're looking for?
Leave it to our experts.
See the back of this catalogue and contact the nearest StoreVan point or visit our website.



* Inclusief bevestigingsmateriaal - Fixing kit included

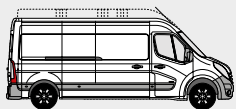

INRICHTINGSVOORBEELDEN - FITTINGS EXAMPLES

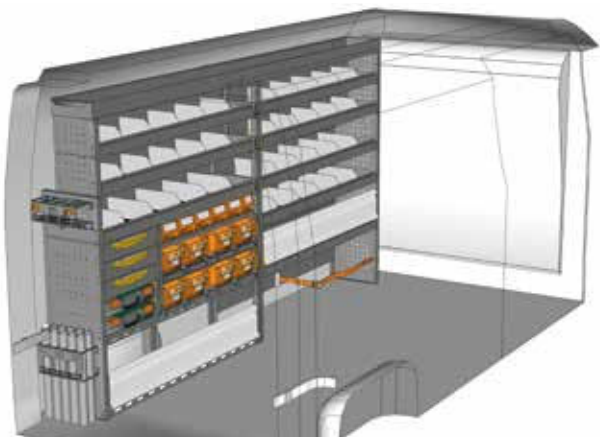

VOORBEELD - EXAMPLE

MA 3017 01*

B=3048 T=365 H=1690 mm - W=3048 D=365 H=1690 mm

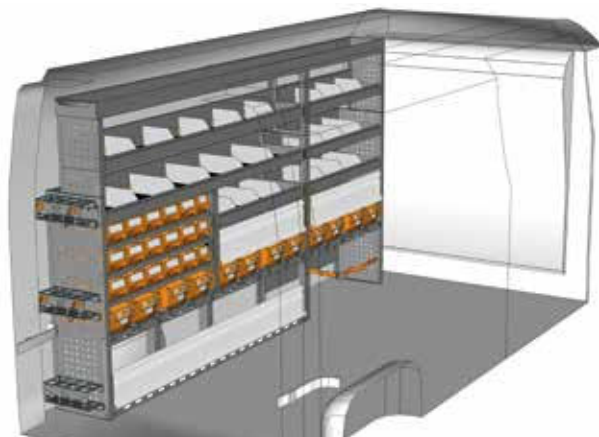
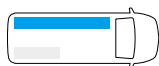

VOORBEELD - EXAMPLE

MA 3017 02*

B=3048 T=365 H=1690 mm - W=3048 D=365 H=1690 mm

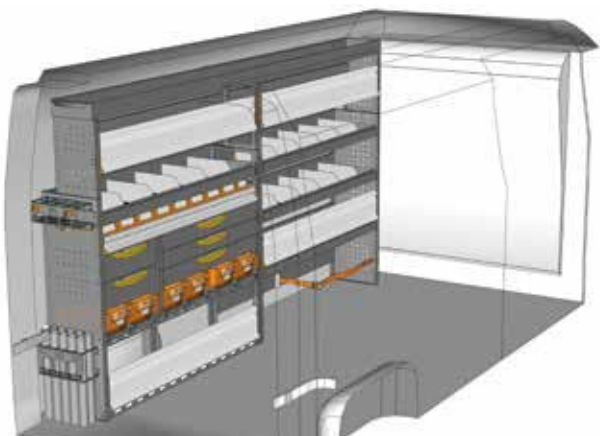
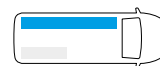

VOORBEELD - EXAMPLE

MA 3017 03*

B=3048 T=365 H=1690 mm - W=3048 D=365 H=1690 mm

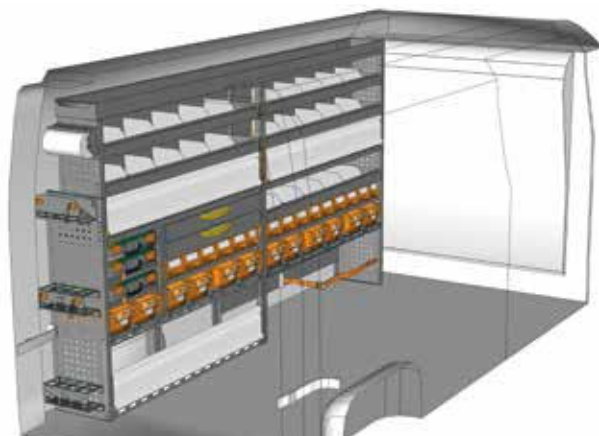
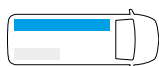

VOORBEELD - EXAMPLE

MA 3017 04*

B=3048 T=365 H=1690 mm - W=3048 D=365 H=1690 mm

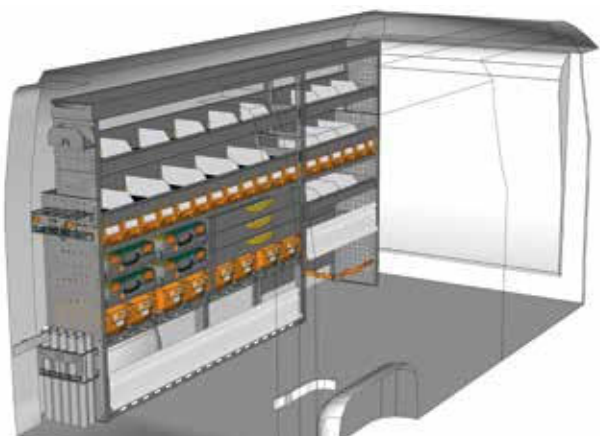
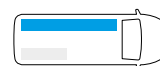

VOORBEELD - EXAMPLE

MA 3017 05*

B=3048 T=365 H=1690 mm - W=3048 D=365 H=1690 mm

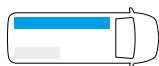

VOORBEELD - EXAMPLE

MA 3017 07*

B=3048 T=365 H=1690 mm - W=3048 D=365 H=1690 mm



* Inclusief bevestigingsmateriaal - Fixing kit included

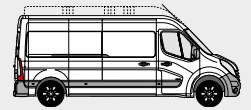

INRICHTINGSVOORBEELDEN - FITTINGS EXAMPLES

BEDRIJFSWAGEN - PANEL VAN
RENAULT MASTER

SAFETY

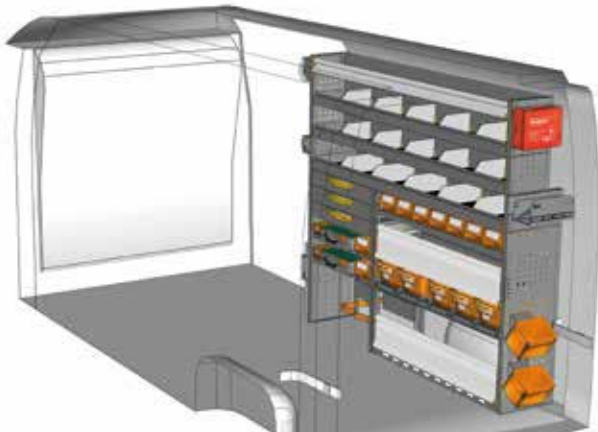

VOORBEELD - EXAMPLE

MA 1917 02*

B=1942 T=365 H=1700 mm - W=1942 D=365 H=1700 mm

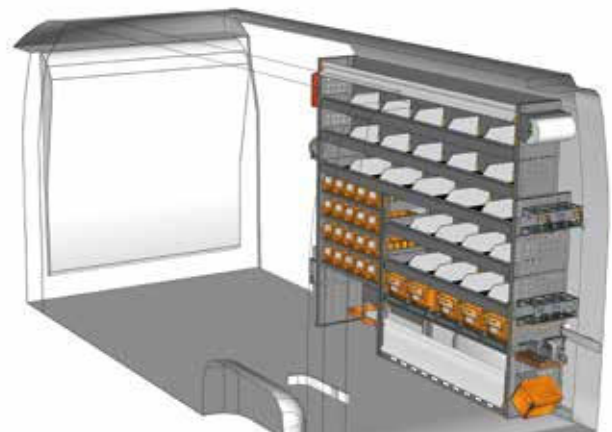
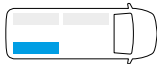

VOORBEELD - EXAMPLE

MA 1917 03*

B=1942 T=365 H=1700 mm - W=1942 D=365 H=1700 mm

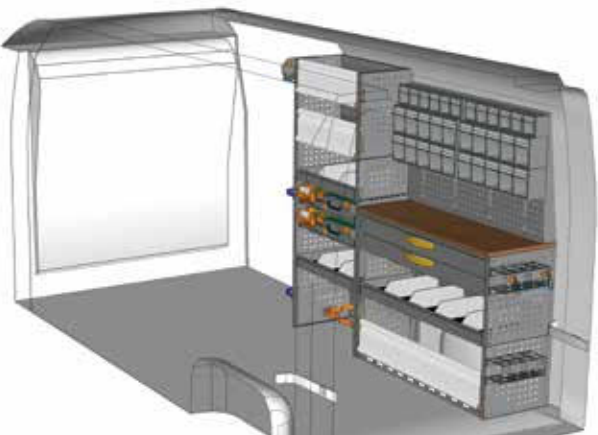
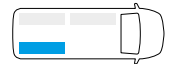

VOORBEELD - EXAMPLE

MA 1917 07*

B=1942 T=445 H=1700 mm - W=1942 D=445 H=1700 mm

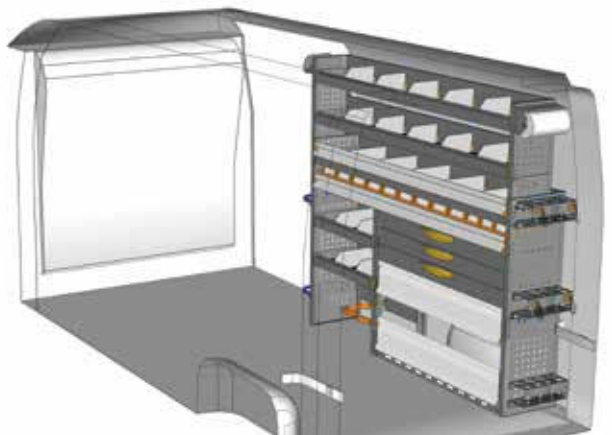
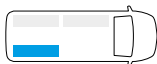

VOORBEELD - EXAMPLE

MA 1917 08*

B=1942 T=365 H=1700 mm - W=1942 D=365 H=1700 mm

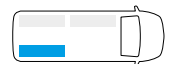

Aanzicht vanuit de schuifdeur
View from side door

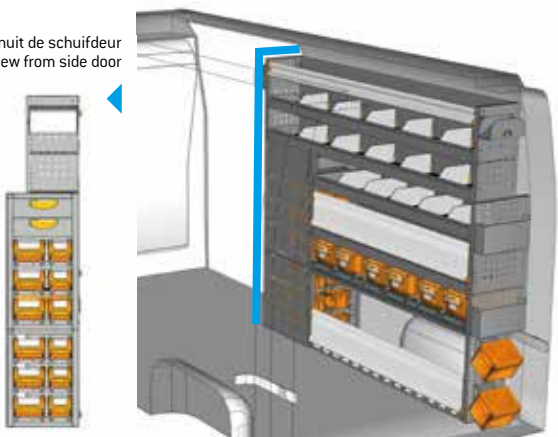

VOORBEELD - EXAMPLE

MA 2017 01*

B=2032 T=365 H=1700 mm - W=2032 D=365 H=1700 mm

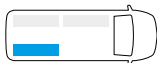

Heeft u uw ideale inrichting niet gevonden?
Voor bedrijfswageninrichtingen op maat neemt u contact op met onze vakmensen.
Op de achterzijde vindt u de adresgegevens of bezoek onze website www.storevannederland.nl

Didn't find the equipment you're looking for?
Leave it to our experts.
See the back of this catalogue and contact the nearest StoreVan point or visit our website.



* Inclusief bevestigingsmateriaal - Fixing kit included

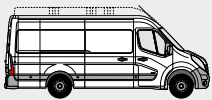

L3 H2 / H3

Achterwielaandrijving - Rear wheel drive

RENAULT MASTER
BEDRIJFSWAGEN - PANEL VAN

SAFETY

INRICHTINGSVOORBEELDEN - FITTINGS EXAMPLES

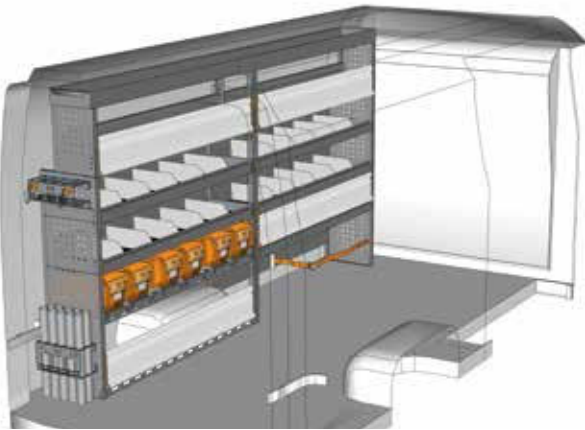

VOORBEELD - EXAMPLE

MA 3016 01*

B=3048 T=365 H=1640 mm - W=3048 D=365 H=1640 mm

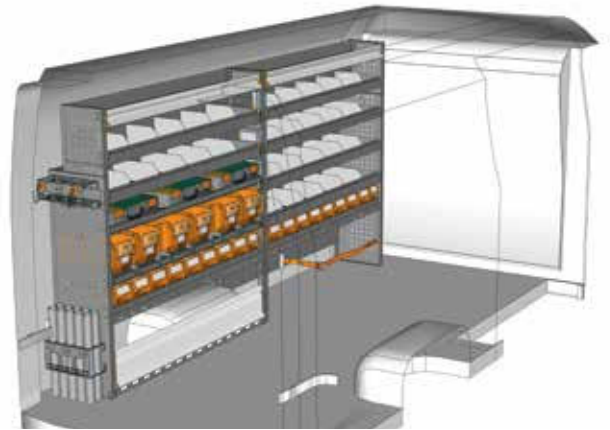
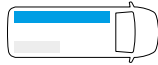

VOORBEELD - EXAMPLE

MA 3016 02*

B=3048 T=365 H=1550 mm - W=3048 D=365 H=1550 mm

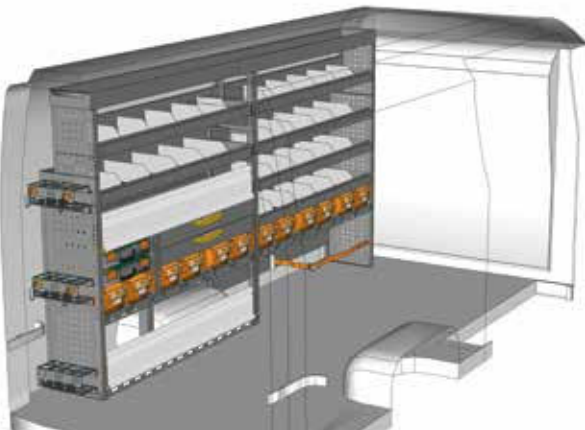

VOORBEELD - EXAMPLE

MA 3016 03*

B=3048 T=365 H=1640 mm - W=3048 D=365 H=1640 mm

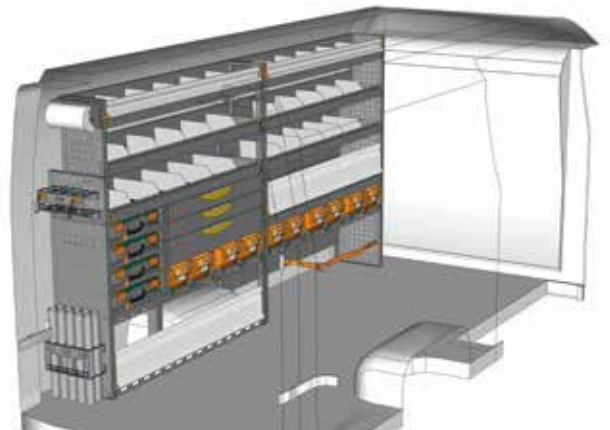
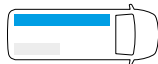

VOORBEELD - EXAMPLE

MA 3016 04*

B=3048 T=365 H=1600 mm - W=3048 D=365 H=1600 mm

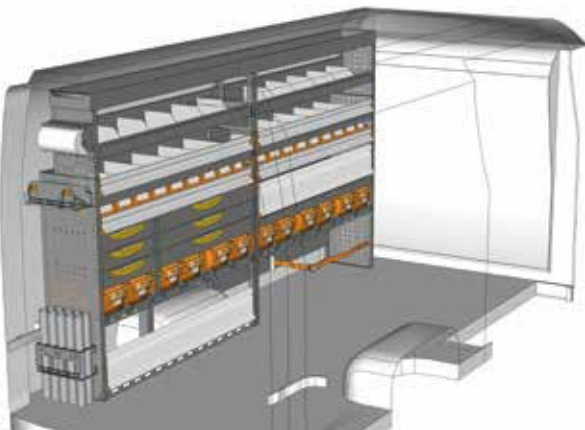

VOORBEELD - EXAMPLE

MA 3016 05*

B=3048 T=365 H=1640 mm - W=3048 D=365 H=1640 mm

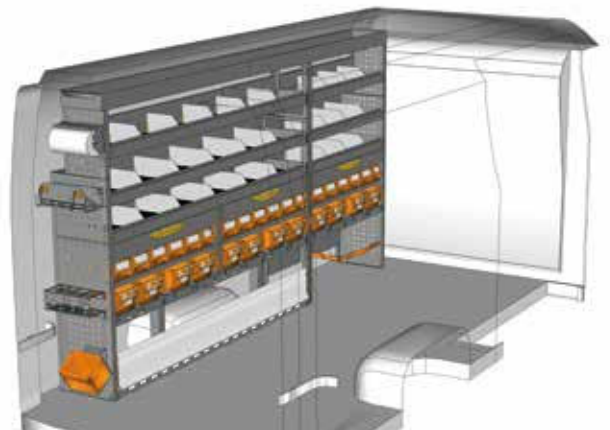
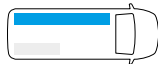

VOORBEELD - EXAMPLE

MA 3016 06*

B=3048 T=365 H=1640 mm - W=3048 D=365 H=1640 mm

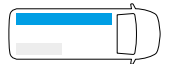

* Inclusief bevestigingsmateriaal - Fixing kit included

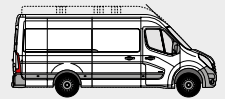

INRICHTINGSVOORBEELDEN - FITTINGS EXAMPLES

BEDRIJFSWAGEN - PANEL VAN
RENAULT MASTER

SAFETY

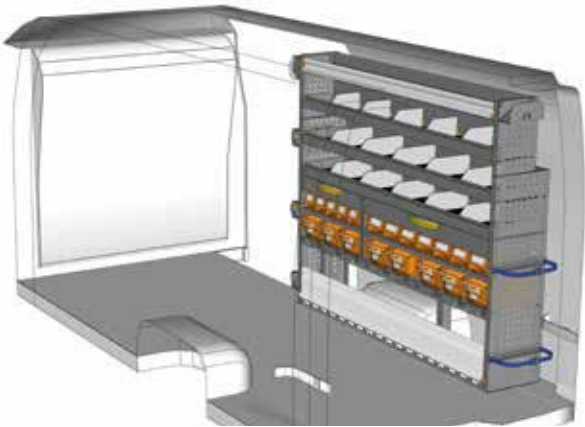

VOORBEELD - EXAMPLE

MA 1916 01*

B=1942 T=365 H=1600 mm - W=1942 D=365 H=1600 mm

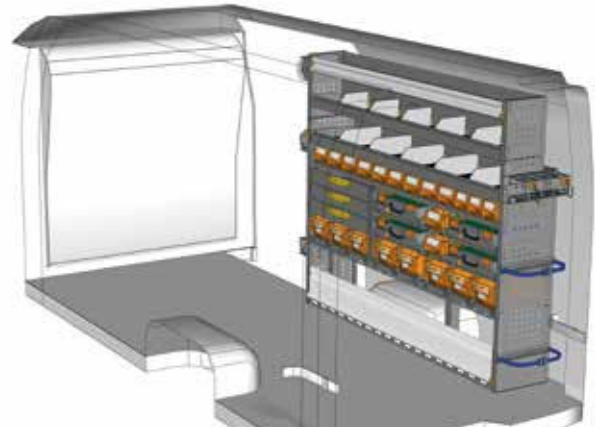
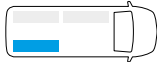

VOORBEELD - EXAMPLE

MA 1916 02*

B=1942 T=365 H=1600 mm - W=1942 D=365 H=1600 mm

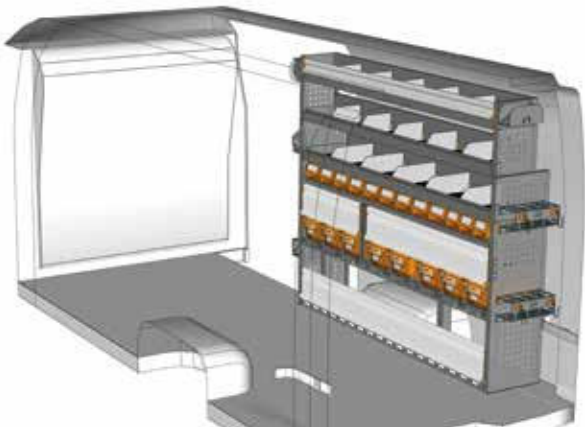
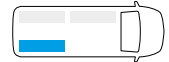

VOORBEELD - EXAMPLE

MA 1916 03*

B=1942 T=365 H=1600 mm - W=1942 D=365 H=1600 mm

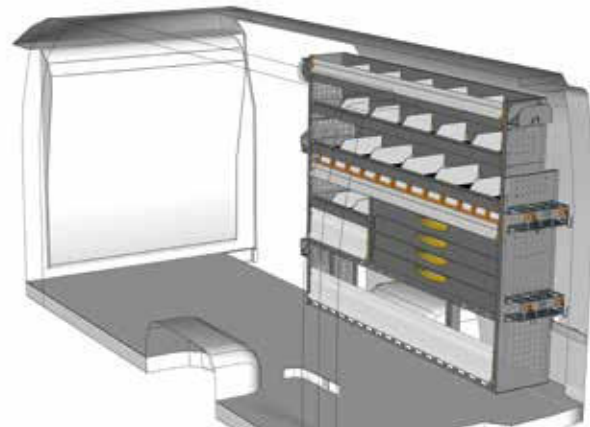
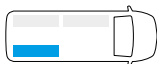

VOORBEELD - EXAMPLE

MA 1916 04*

B=1942 T=365 H=1600 mm - W=1942 D=365 H=1600 mm

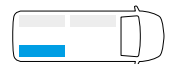

Aanzicht vanuit de schuifdeur
View from side door

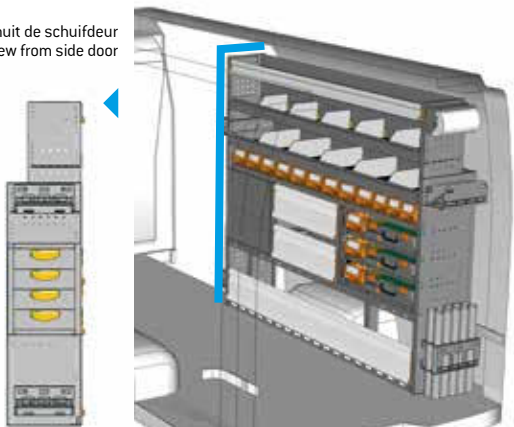

VOORBEELD - EXAMPLE

MA 1916 05*

B=1942 T=445 H=1600 mm - W=1942 D=445 H=1600 mm

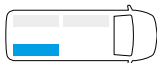

Heeft u uw ideale inrichting niet gevonden?
Voor bedrijfswageninrichtingen op maat neemt u contact op met onze vakmensen.
Op de achterzijde vindt u de adresgegevens of bezoek onze website www.storevannederland.nl

Didn't find the equipment you're looking for?
Leave it to our experts.
See the back of this catalogue and contact the nearest StoreVan point or visit our website.



* Inclusief bevestigingsmateriaal - Fixing kit included



RENAULT MASTER
BEDRIJFSWAGEN - PANEL VAN

PROFESSIONAL



**Perfekte integratie
tussen bedrijfswagen
en mobiele werkplaats**

Perfect integration
between vehicle and
mobile workshop
equipment



De professionele StoreVan bedrijfswageninrichting wordt perfect geïntegreerd in uw voertuig. Vervaardigd uit doos- en kokerprofielen van verzinkt staal, voorzien van een dompelbad verfsysteem, net als uw bedrijfswagen. Sterk als staal en licht als aluminium. Geïntegreerde bevestigingssysteem zorgen ervoor, dat volgens de nieuwste richtlijnen en wetgeving ladingen kunnen worden vervoerd.

The Store Van **PROFESSIONAL equipment solution** is perfectly integrated in your vehicle and has been designed to enhance its structural and dynamic characteristics. The modules of this new **equipment for commercial vehicles**, such as shelving units for vans, are factory fitted with elements ensuring a perfect load anchoring to the chassis of your vehicle with "Airline" anchoring systems. Both vertical and horizontal load restraining elements can be installed in your van thanks to the new SAFETY FLOOR panel.





INRICHTINGSVOORBEELDEN - FITTINGS EXAMPLES

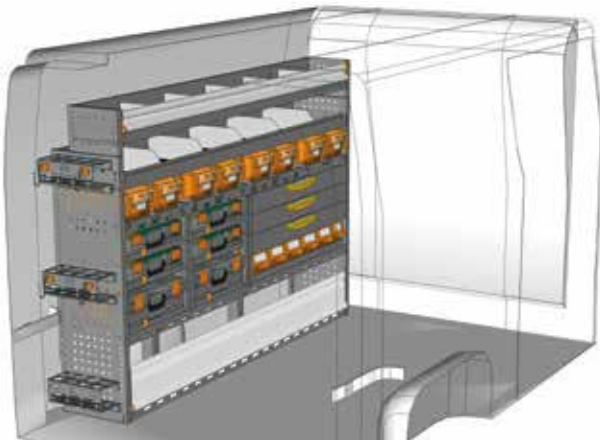

VOORBEELD - EXAMPLE

MA 2014 P1*

B=2032 T=365 H=1400 mm - W=2032 D=365 H=1400 mm

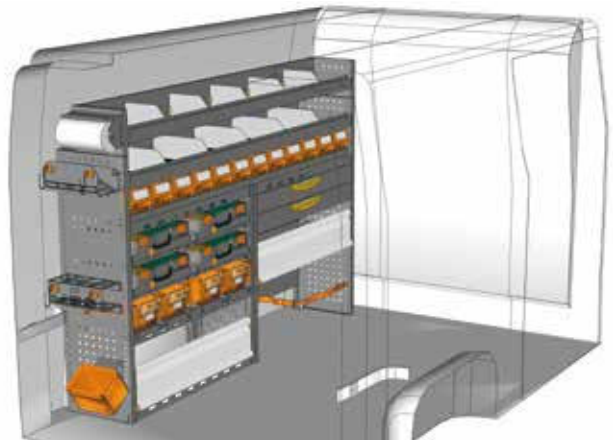
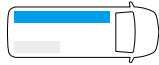

VOORBEELD - EXAMPLE

MA 2014 P2*

B=2032 T=365 H=1400 mm - W=2032 D=365 H=1400 mm

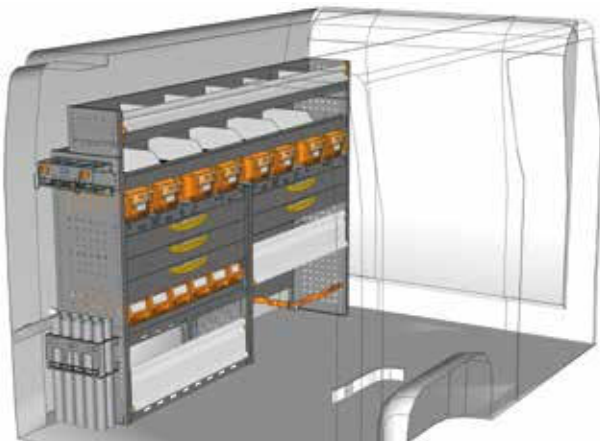
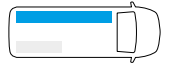

VOORBEELD - EXAMPLE

MA 2014 P3*

B=2032 T=365 H=1400 mm - W=2032 D=365 H=1400 mm

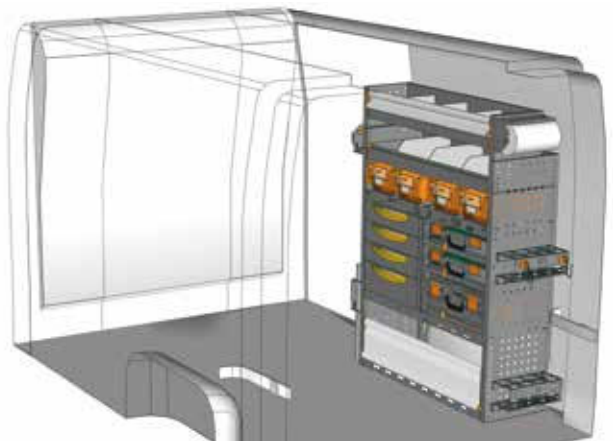
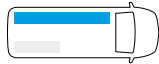

VOORBEELD - EXAMPLE

MA 1014 P1*

B=1016 T=365 H=1400 mm - W=1016 D=365 H=1400 mm

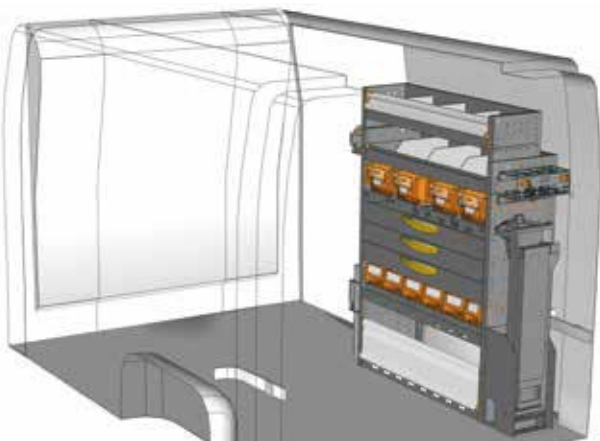
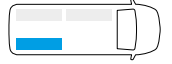

VOORBEELD - EXAMPLE

MA 1014 P2*

B=1016 T=365 H=1400 mm - W=1016 D=365 H=1400 mm

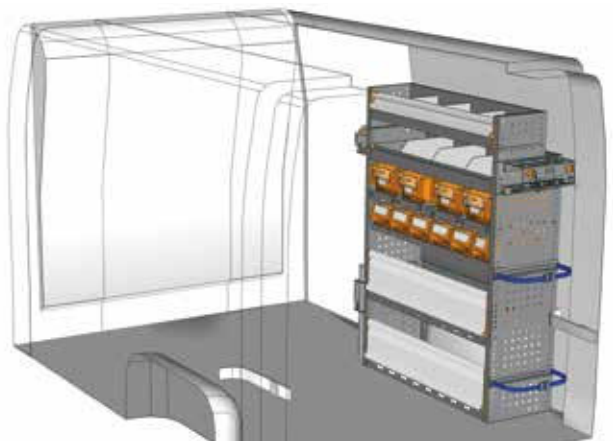
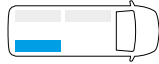

VOORBEELD - EXAMPLE

MA 1014 P3*

B=1016 T=365 H=1400 mm - W=1016 D=365 H=1400 mm



* Inclusief bevestigingsmateriaal - Fixing kit included



INRICHTINGSVOORBEELDEN - FITTINGS EXAMPLES

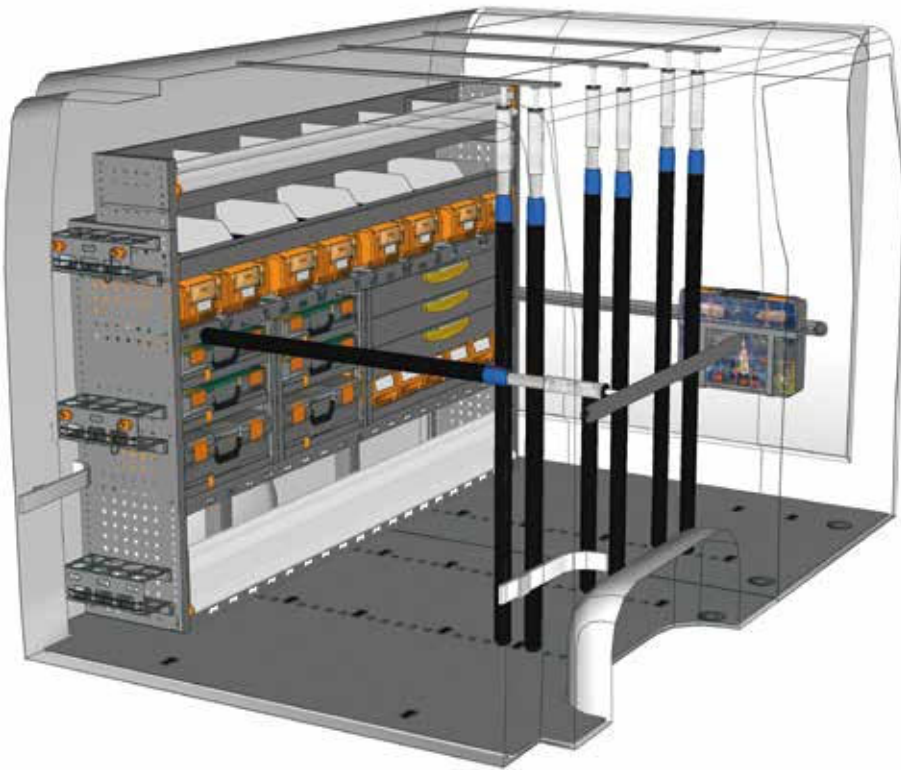

VOORBEELD - EXAMPLE

EXAMPLE MA L1H1 P1*



1 x MA 2014 P1	3 x V18025 15
1 x MA 10G1 A0	1 x B0X080
1 x V22585	1 x CPV080
1 x V22131	2 x V22136
6 x V22017	2 x V22124
1 x V18029 15	2 x V22148
1 x V18029 10	1 x YELLOW
4 x V22106	4 x V225820

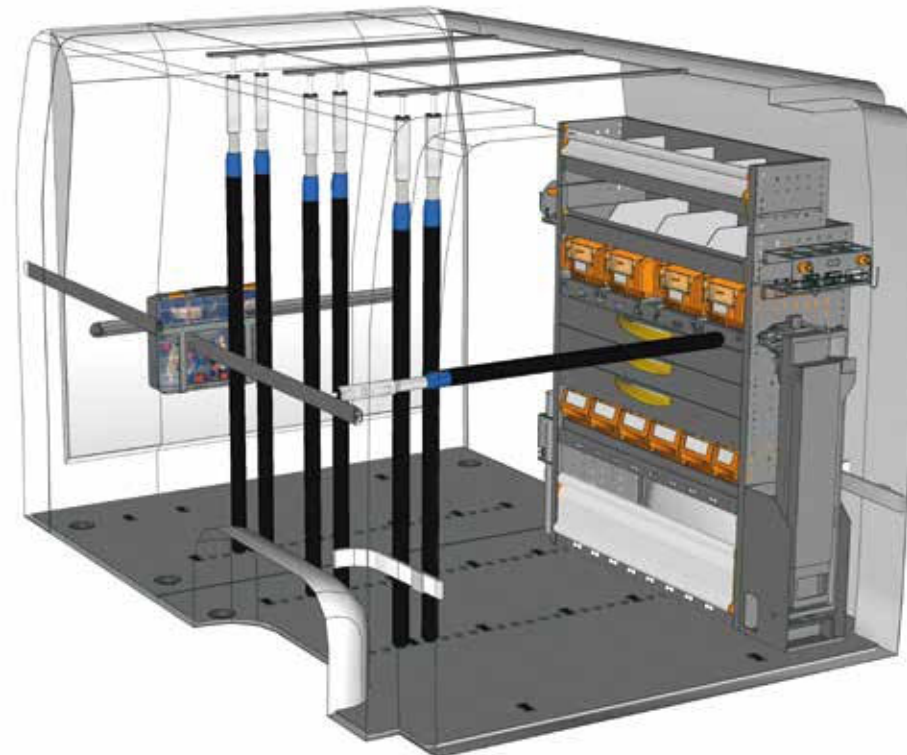

VOORBEELD - EXAMPLE

EXAMPLE MA L1H1 P2*



1 x MA 1014 P2	3 x V18025 15
1 x MA 10G1 A0	1 x B0X080
1 x V22585	1 x CPV080
1 x V22131	2 x V22136
6 x V22017	2 x V22124
2 x V18029 10	2 x V22148
1 x V18029 15	1 x YELLOW
6 x V22106	4 x V225820



Zie pagina's 10/11
see pages 10/11

* Inclusief bevestigingsmateriaal - Fixing kit included

BEDRIJFSWAGEN - PANEL VAN
RENAULT MASTER

PROFESSIONAL

Heeft u uw ideale inrichting niet gevonden?
Voor bedrijfswageninrichtingen op maat neemt u contact op met onze vakmensen.
Op de achterzijde vindt u de adresgegevens of bezoek onze website www.storevannederland.nl

Didn't find the equipment you're looking for?
Leave it to our experts.
See the back of this catalogue and contact the nearest StoreVan point or visit our website.



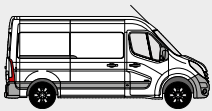

INRICHTINGSVOORBEELDEN - FITTINGS EXAMPLES

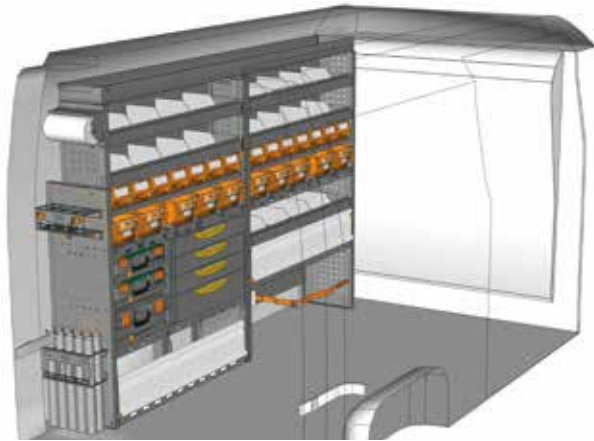

VOORBEELD - EXAMPLE

MA 2417 P1*

B=2450 T=365 H=1690 mm - W=2450 D=365 H=1690 mm

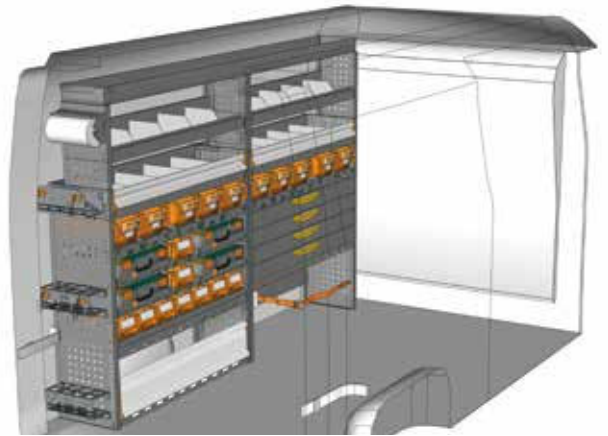
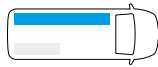

VOORBEELD - EXAMPLE

MA 2417 P2*

B=2450 T=365 H=1690 mm - W=2450 D=365 H=1690 mm

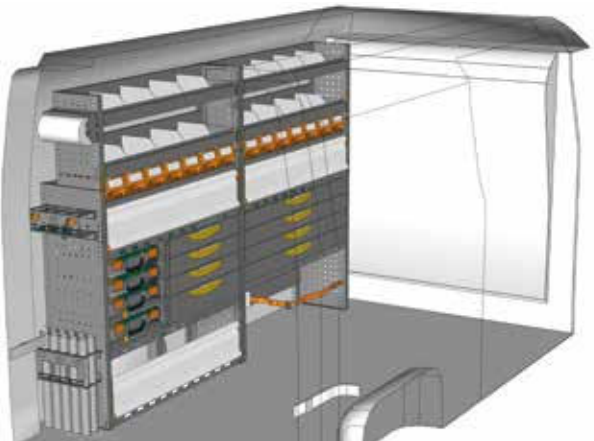

VOORBEELD - EXAMPLE

MA 2417 P3*

B=2450 T=365 H=1650 mm - W=2450 D=365 H=1650 mm

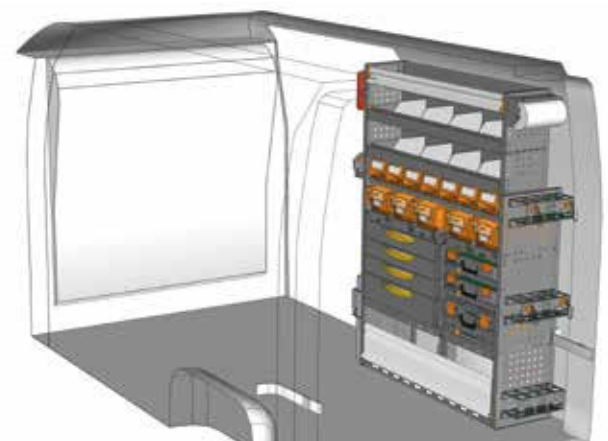
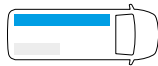

VOORBEELD - EXAMPLE

MA 1217 P1*

B=1225 T=365 H=1700 mm - W=1225 D=365 H=1700 mm

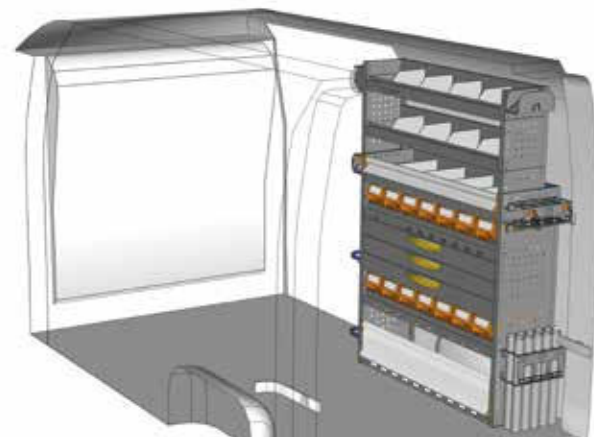
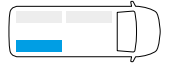

VOORBEELD - EXAMPLE

MA 1217 P2*

B=1225 T=365 H=1700 mm - W=1225 D=365 H=1700 mm

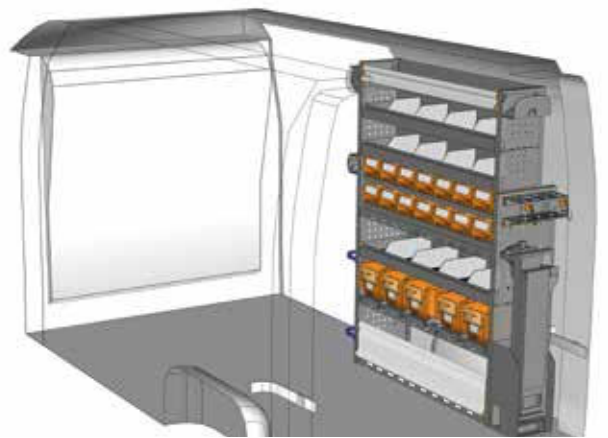
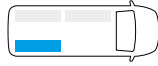

VOORBEELD - EXAMPLE

MA 1217 P3*

B=1225 T=365 H=1700 mm - W=1225 D=365 H=1700 mm

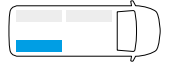

* Inclusief bevestigingsmateriaal - Fixing kit included

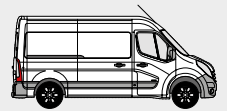

INRICHTINGSVOORBEELDEN - FITTINGS EXAMPLES

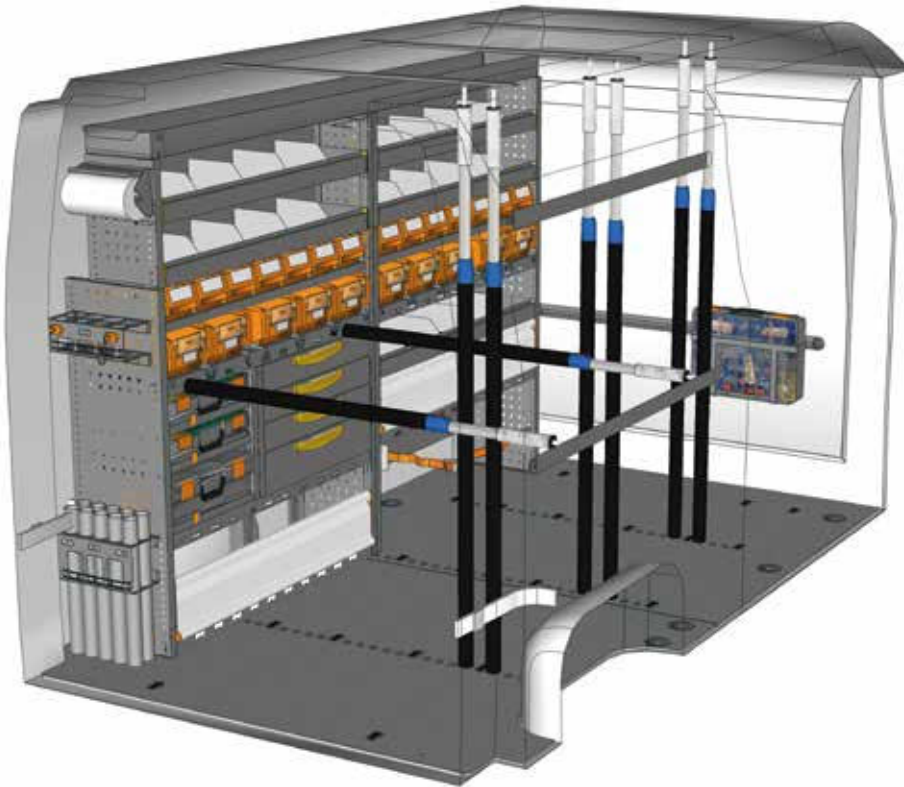

VOORBEELD - EXAMPLE

EXAMPLE MA L2H2 P1*



1 x MA 2417 P1	1 x BOX080
1 x MA 20G1 A0	1 x CPV080
1 x V22585	2 x V22136
2 x V22131	2 x V22124
6 x V22017	2 x V22148
3 x V18029 15	1 x YELLOW
6 x V22106	4 x V225820
3 x V18025 15	

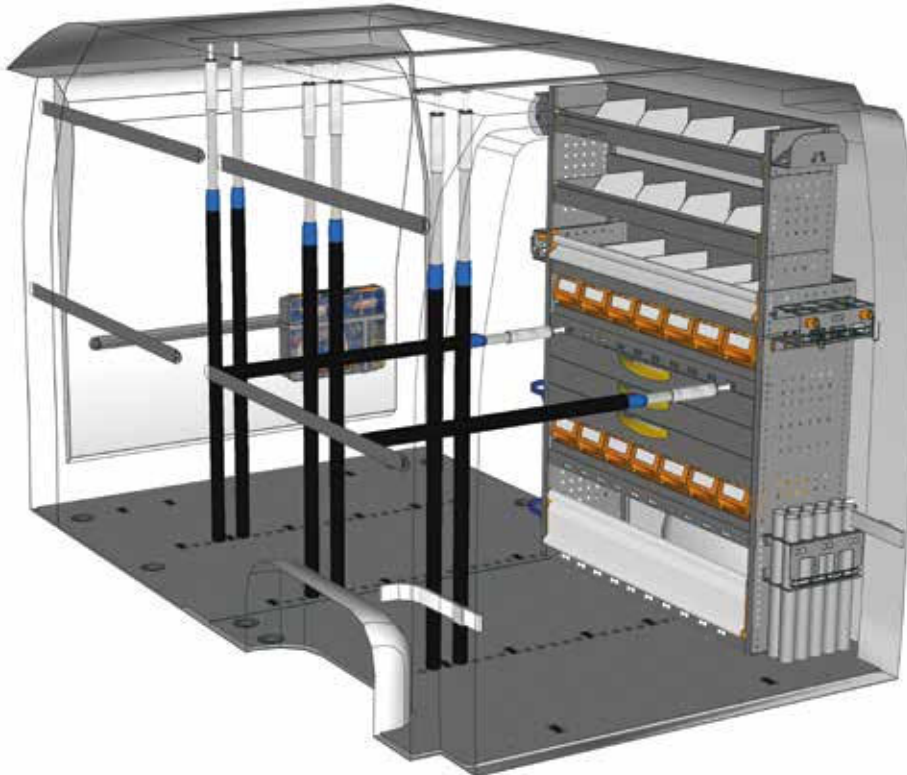

VOORBEELD - EXAMPLE

EXAMPLE MA L2H2 P2*



1 x MA 1217 P2	1 x BOX080
1 x MA 20G1 A0	1 x CPV080
1 x V22585	2 x V22136
2 x V22131	2 x V22124
6 x V22017	2 x V22148
5 x V18029 15	1 x YELLOW
10 x V22106	4 x V225820
3 x V18025 15	

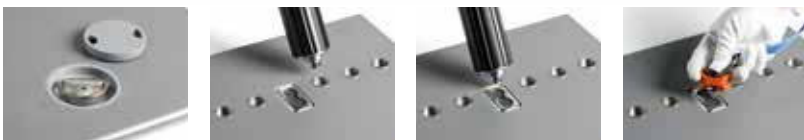

Zie pagina's 10/11
see pages 10/11

* Inclusief bevestigingsmateriaal - Fixing kit included

Heeft u uw ideale inrichting niet gevonden?
Voor bedrijfswageninrichtingen op maat neemt u contact op met onze vakmensen.
Op de achterzijde vindt u de adresgegevens of bezoek onze website www.storevannederland.nl

Didn't find the equipment you're looking for?
Leave it to our experts.
See the back of this catalogue and contact the nearest StoreVan point or visit our website.



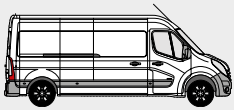

INRICHTINGSVOORBEELDEN - FITTINGS EXAMPLES

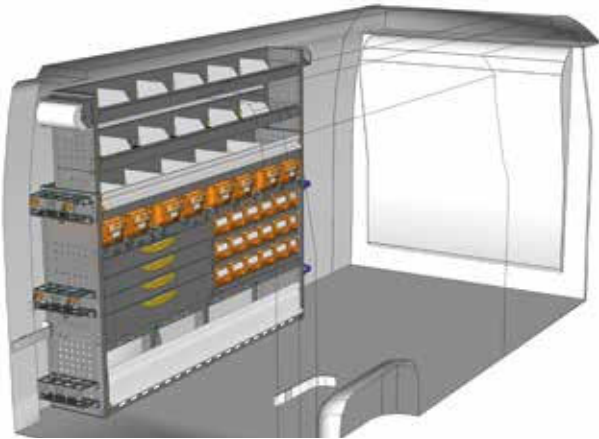

VOORBEELD - EXAMPLE

MA 2017 P1*

B=2032 T=365 H=1700 mm - W=2032 D=365 H=1700 mm

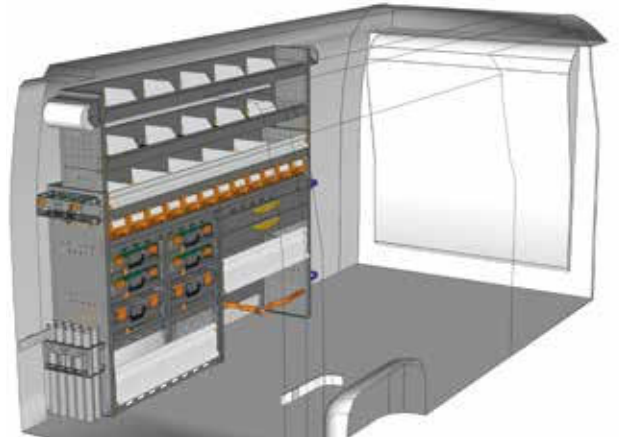
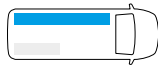

VOORBEELD - EXAMPLE

MA 2017 P2*

B=2032 T=365 H=1700 mm - W=2032 D=365 H=1700 mm

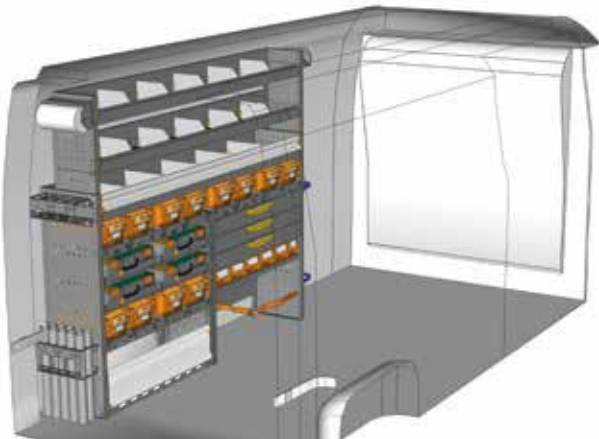
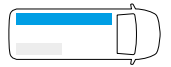

VOORBEELD - EXAMPLE

MA 2017 P3*

B=2032 T=365 H=1700 mm - W=2032 D=365 H=1700 mm

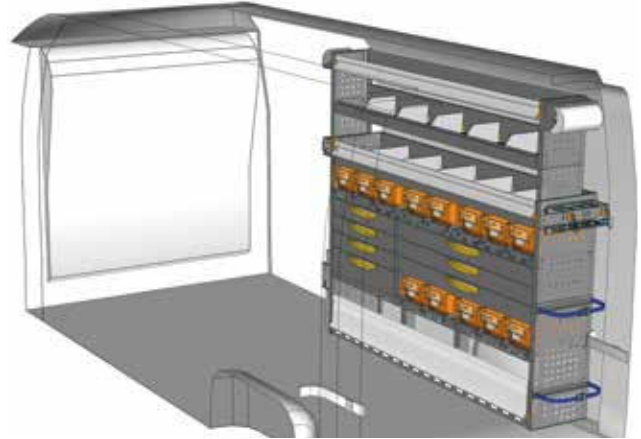
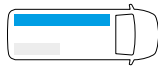

VOORBEELD - EXAMPLE

MA 1917 P1*

B=1942 T=365 H=1700 mm - W=1942 D=365 H=1700 mm

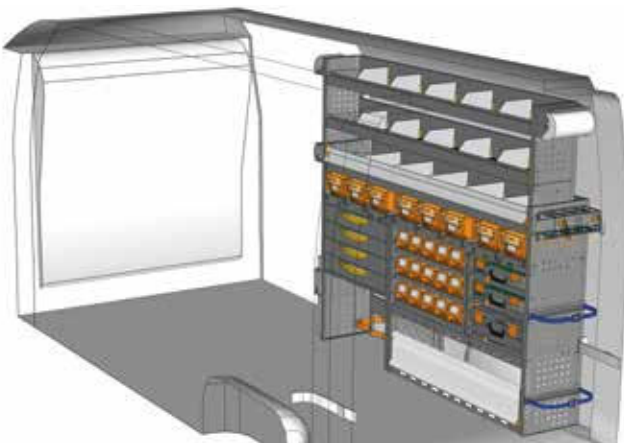
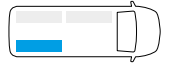

VOORBEELD - EXAMPLE

MA 1917 P2*

B=1942 T=365 H=1700 mm - W=1942 D=365 H=1700 mm

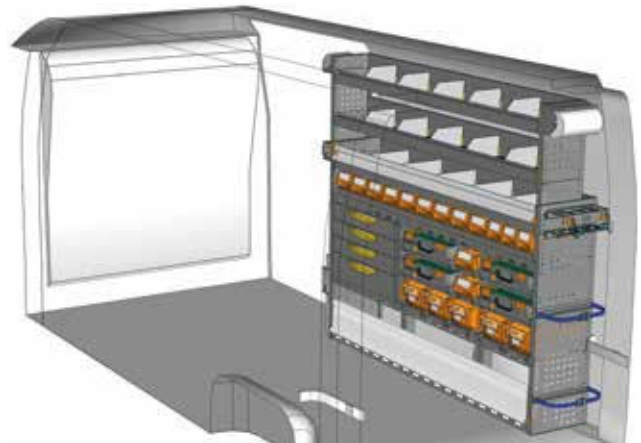
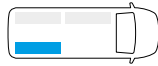

VOORBEELD - EXAMPLE

MA 1917 P3*

B=1942 T=365 H=1700 mm - W=1942 D=365 H=1700 mm

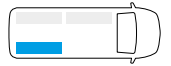

* Inclusief bevestigingsmateriaal - Fixing kit included

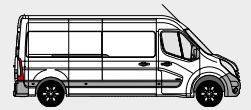

INRICHTINGSVOORBEELDEN - FITTINGS EXAMPLES

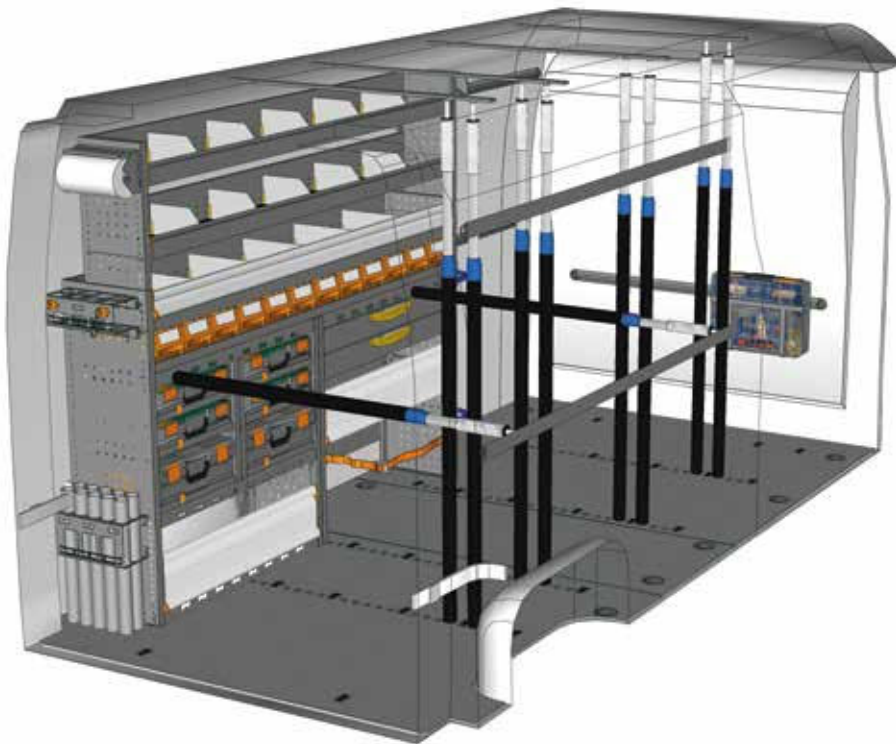

VOORBEELD - EXAMPLE

EXAMPLE MA L3H2 P1*



1 x MA 2017 P2	4 x V18025 15
1 x MA 30G1 A0	1 x B0X080
1 x V22585	1 x CPV080
2 x V22131	2 x V22136
8 x V22017	2 x V22124
3 x V18029 15	2 x V22148
2 x V18029 20	1 x YELLOW
10 x V22106	4 x V225820

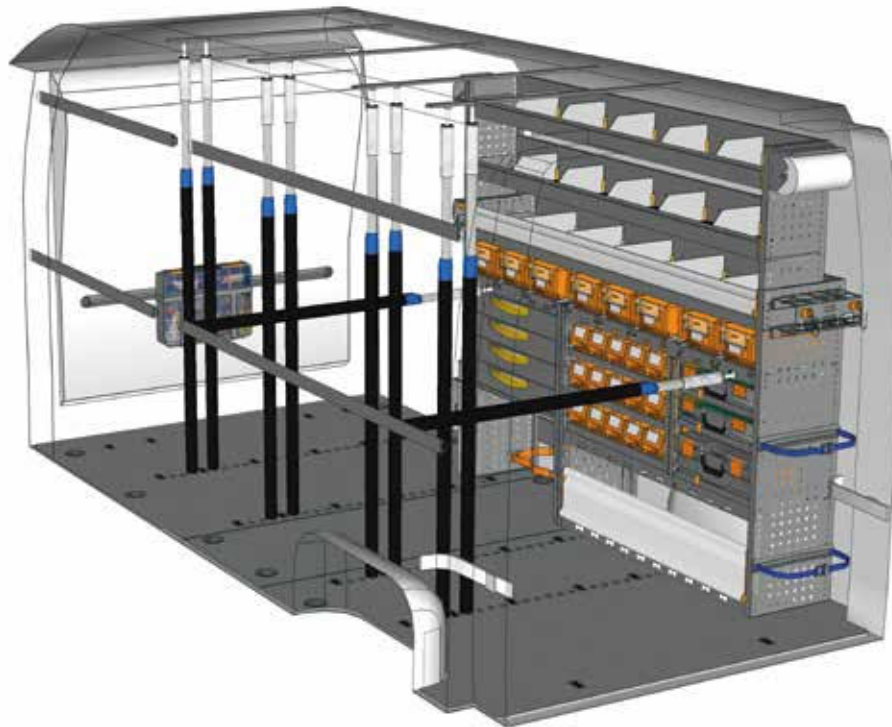

VOORBEELD - EXAMPLE

EXAMPLE MA L3H2 P2*



1 x MA 1917 P2	4 x V18025 15
1 x MA 30G1 A0	1 x B0X080
1 x V22585	1 x CPV080
2 x V22131	2 x V22136
8 x V22017	2 x V22124
3 x V18029 15	2 x V22148
2 x V18029 20	1 x YELLOW
10 x V22106	4 x V225820

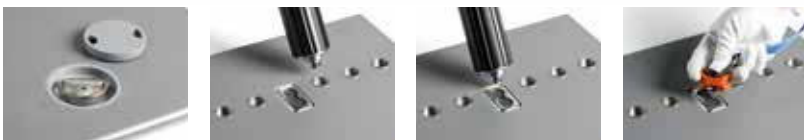

Zie pagina's 10/11
see pages 10/11

* Inclusief bevestigingsmateriaal - Fixing kit included

Heeft u uw ideale inrichting niet gevonden?
Voor bedrijfswageninrichtingen op maat neemt u contact op met onze vakmensen.
Op de achterzijde vindt u de adresgegevens of bezoek onze website www.storevannederland.nl

Didn't find the equipment you're looking for?
Leave it to our experts.
See the back of this catalogue and contact the nearest StoreVan point or visit our website.



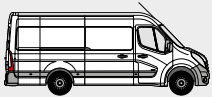

INRICHTINGSVOORBEELDEN - FITTINGS EXAMPLES

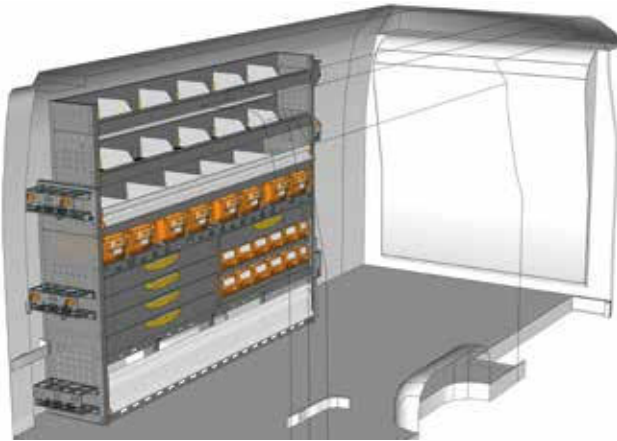

VOORBEELD - EXAMPLE

MA 2016 P1*

B=2032 T=365 H=1600 mm - W=2032 D=365 H=1600 mm

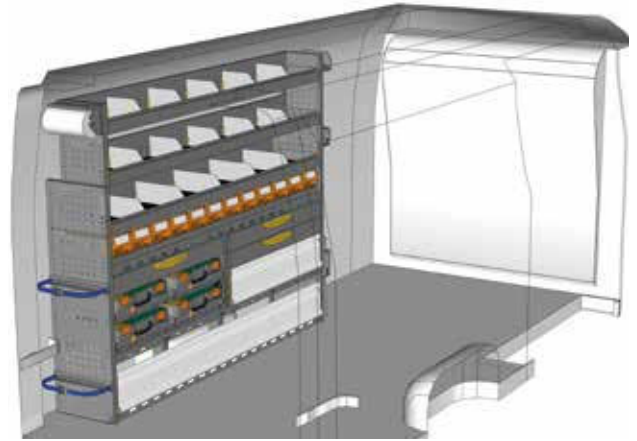
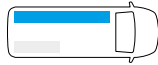

VOORBEELD - EXAMPLE

MA 2016 P2*

B=2032 T=365 H=1600 mm - W=2032 D=365 H=1600 mm

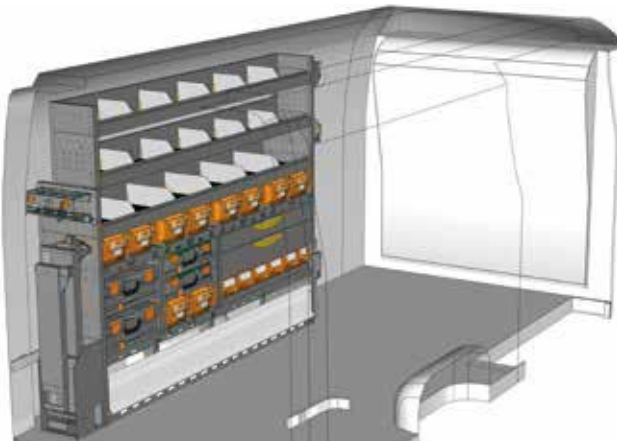
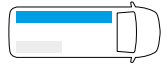

VOORBEELD - EXAMPLE

MA 2016 P3*

B=2032 T=365 H=1600 mm - W=2032 D=365 H=1600 mm

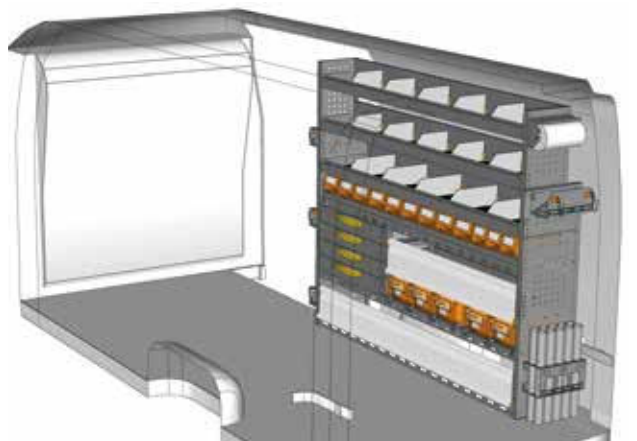
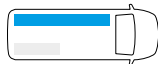

VOORBEELD - EXAMPLE

MA 1916 P1*

B=1942 T=365 H=1600 mm - W=1942 D=365 H=1600 mm

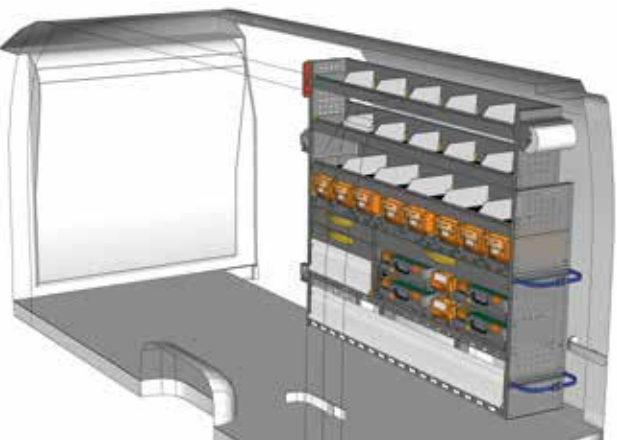
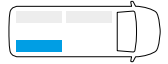

VOORBEELD - EXAMPLE

MA 1916 P2*

B=1942 T=365 H=1600 mm - W=1942 D=365 H=1600 mm

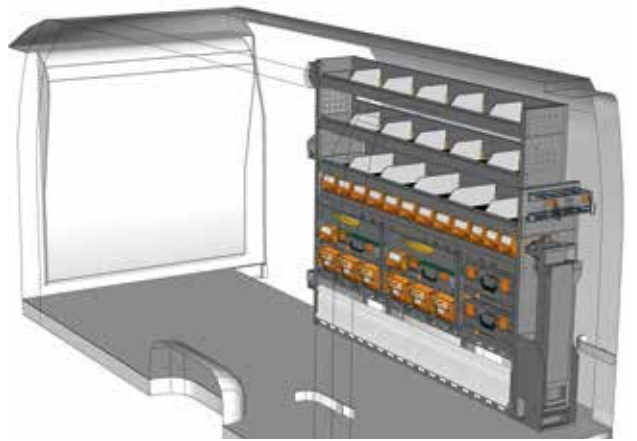
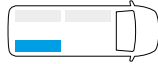

VOORBEELD - EXAMPLE

MA 1916 P3*

B=1942 T=365 H=1600 mm - W=1942 D=365 H=1600 mm

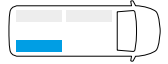

* Inclusief bevestigingsmateriaal - Fixing kit included

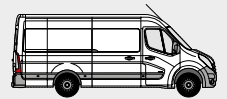

INRICHTINGSVOORBEELDEN - FITTINGS EXAMPLES

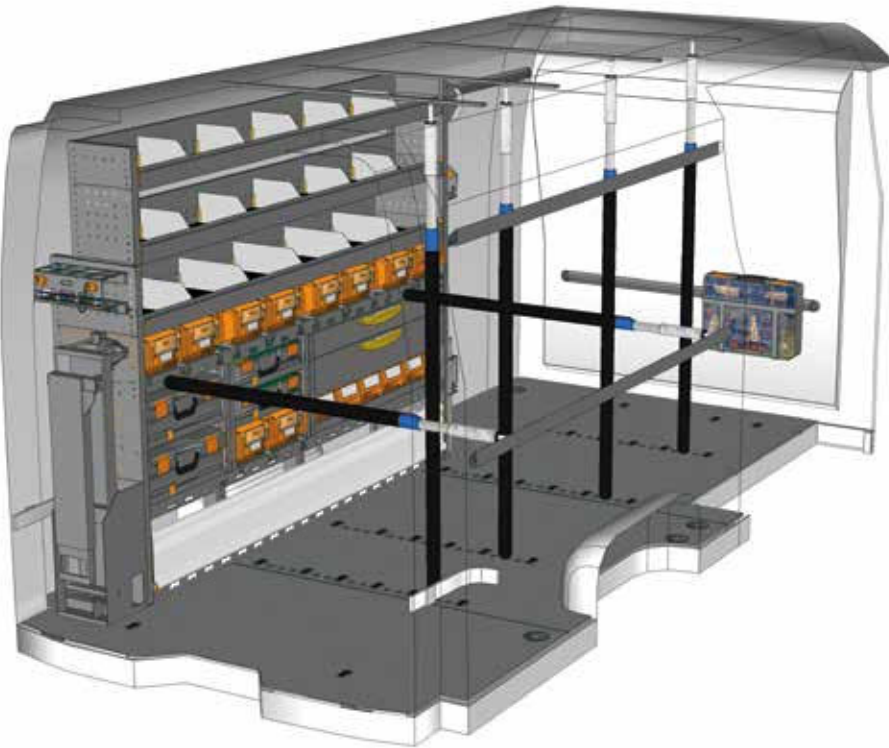

VOORBEELD - EXAMPLE

EXAMPLE MA L2LH2 P1*



1 x MA 2016 P3	4 x V18025 15
1 x MA 2LG1 J0	1 x B0X080
1 x V22585	1 x CPV080
2 x V22131	2 x V22136
4 x V22017	2 x V22124
3 x V18029 15	2 x V22148
2 x V18029 20	1 x YELLOW
10 x V22106	4 x V225820

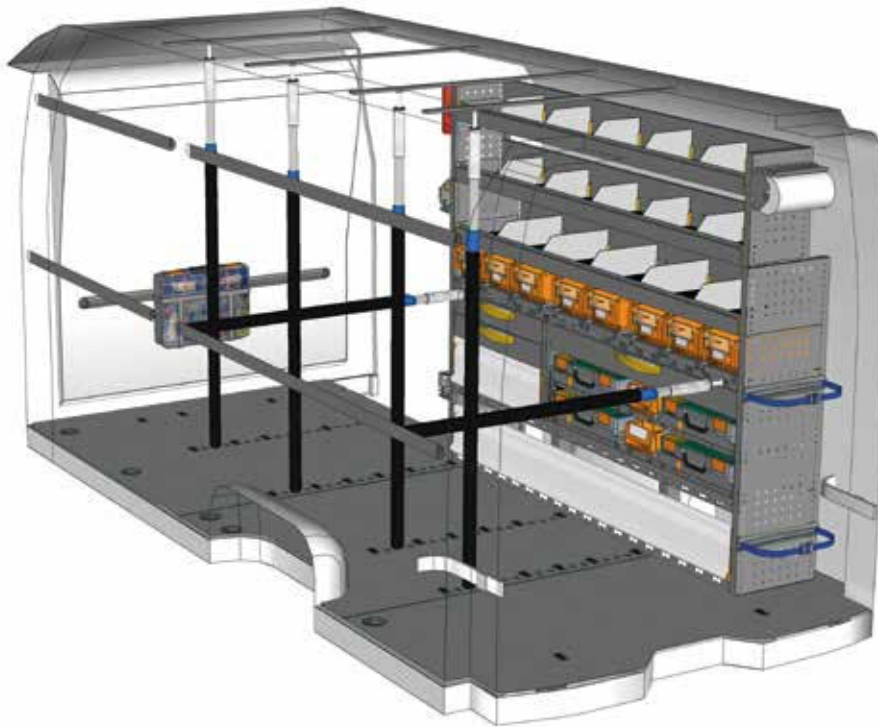

VOORBEELD - EXAMPLE

EXAMPLE MA L2LH2 P2*



1 x MA 1916 P2	4 x V18025 15
1 x MA 2LG1 J0	1 x B0X080
1 x V22585	1 x CPV080
2 x V22131	2 x V22136
4 x V22017	2 x V22124
3 x V18029 15	2 x V22148
2 x V18029 20	1 x YELLOW
10 x V22106	4 x V225820

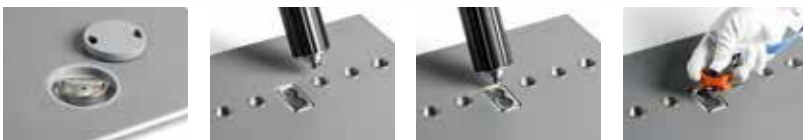

Zie pagina's 10/11
see pages 10/11

* Inclusief bevestigingsmateriaal - Fixing kit included

Heeft u uw ideale inrichting niet gevonden?
Voor bedrijfswageninrichtingen op maat neemt u contact op met onze vakmensen.
Op de achterzijde vindt u de adresgegevens of bezoek onze website www.storevannederland.nl

Didn't find the equipment you're looking for?
Leave it to our experts.
See the back of this catalogue and contact the nearest StoreVan point or visit our website.





**Voertuigen
en mobiliteit**

All-out
mobility



De **mobiele bedrijfswagenuitrustingen** van StoreVan helpen de gebruiker de goederen en gereedschappen gemakkelijk en snel van de bedrijfswagen naar de werkplek te vervoeren. De StoreBoxes 102/136/238 zijn hiervoor een goed voorbeeld. In de module fungeren zij als opbergplaats, maar de koffers kunnen natuurlijk ook uit de module worden gehaald. Op die manier heeft de gebruiker gereedschappen en onderdelen altijd bij de hand. De nieuwe bevestigingsprofielen verbeteren de functionaliteit van de modules zonder gewichtstoename. Zowel verticale als horizontale lading-zekering accessoires kunnen door de SAFETY FLOOR en bevestigingsprofielen worden toegepast.

The **MOBILE equipment solution** integrates Store Van fittings for commercial vehicles with small-parts cases, series STORE BOX 102 – 136 – 238, and trolleys by which **mobile workshop** users can easily carry their goods and tools from their van to the workplace.

The new "Airline" anchoring fittings improve the stability of modules with no weight increase. Here shelving units are integrated with elements where "Airline" anchoring systems can easily fit. Both vertical and horizontal load restraining elements can be installed in your van thanks to the new SAFETY FLOOR flooring panels.



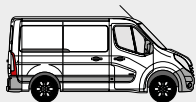

INRICHTINGSVOORBEELDEN - FITTINGS EXAMPLES

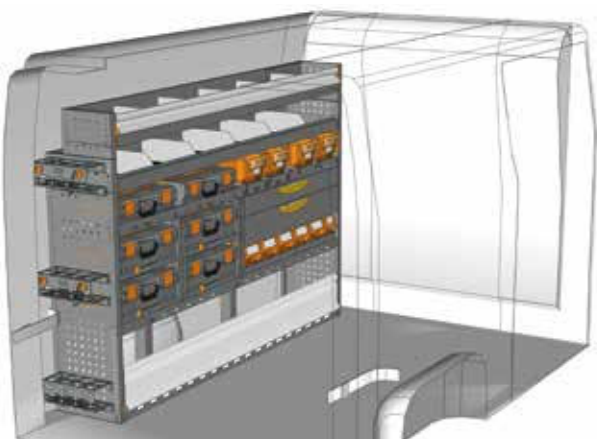

VOORBEELD - EXAMPLE

MA 2014 M1*

B=2032 T=365 H=1400 mm - W=2032 D=365 H=1400 mm

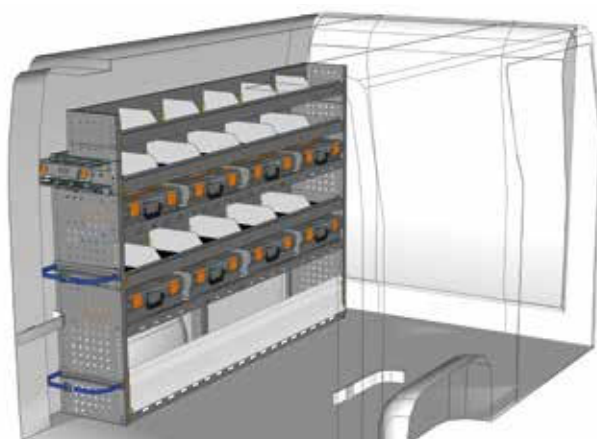
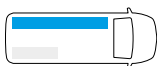

VOORBEELD - EXAMPLE

MA 2014 M2*

B=2032 T=365 H=1400 mm - W=2032 D=365 H=1400 mm

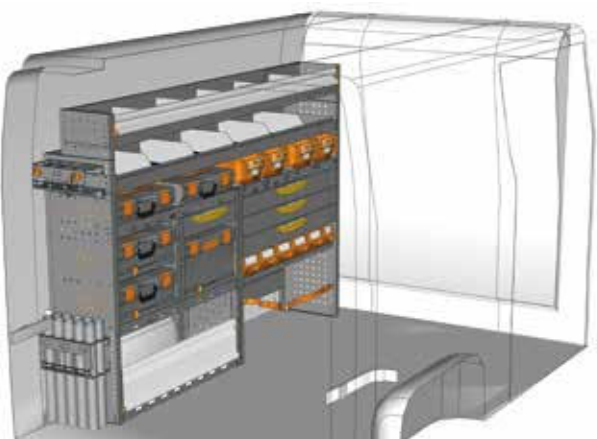
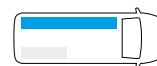

VOORBEELD - EXAMPLE

MA 2014 M3*

B=2032 T=365 H=1400 mm - W=2032 D=365 H=1400 mm

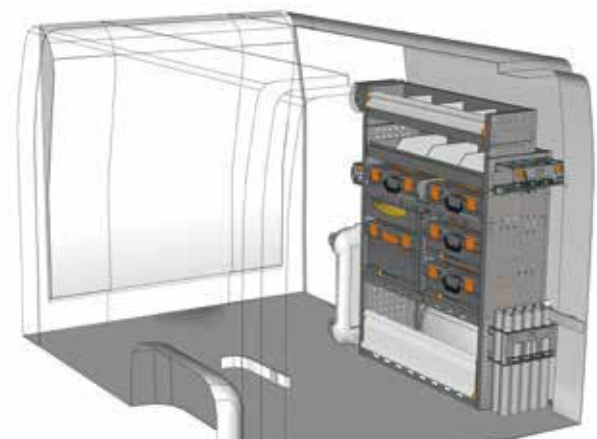
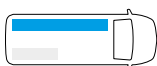

VOORBEELD - EXAMPLE

MA 1014 M1*

B=1016 T=365 H=1400 mm - W=1016 D=365 H=1400 mm

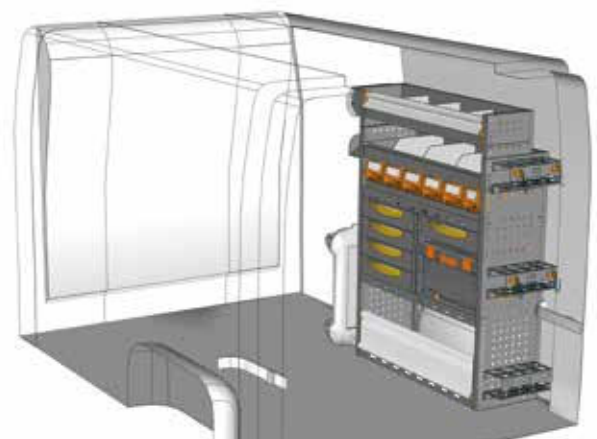
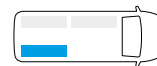

VOORBEELD - EXAMPLE

MA 1014 M2*

B=1016 T=365 H=1400 mm - W=1016 D=365 H=1400 mm

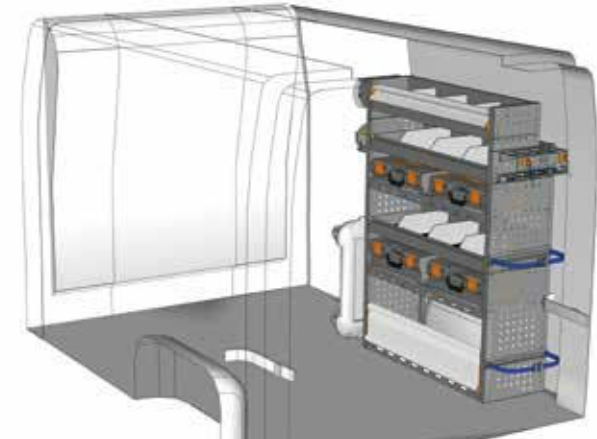
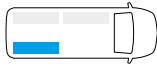

VOORBEELD - EXAMPLE

MA 1014 M3*

B=1016 T=365 H=1400 mm - W=1016 D=365 H=1400 mm

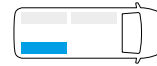

* Inclusief bevestigingsmateriaal - Fixing kit included



INRICHTINGSVOORBEELDEN - FITTINGS EXAMPLES

BEDRIJFSWAGEN - PANEL VAN
RENAULT MASTER

MOBILE

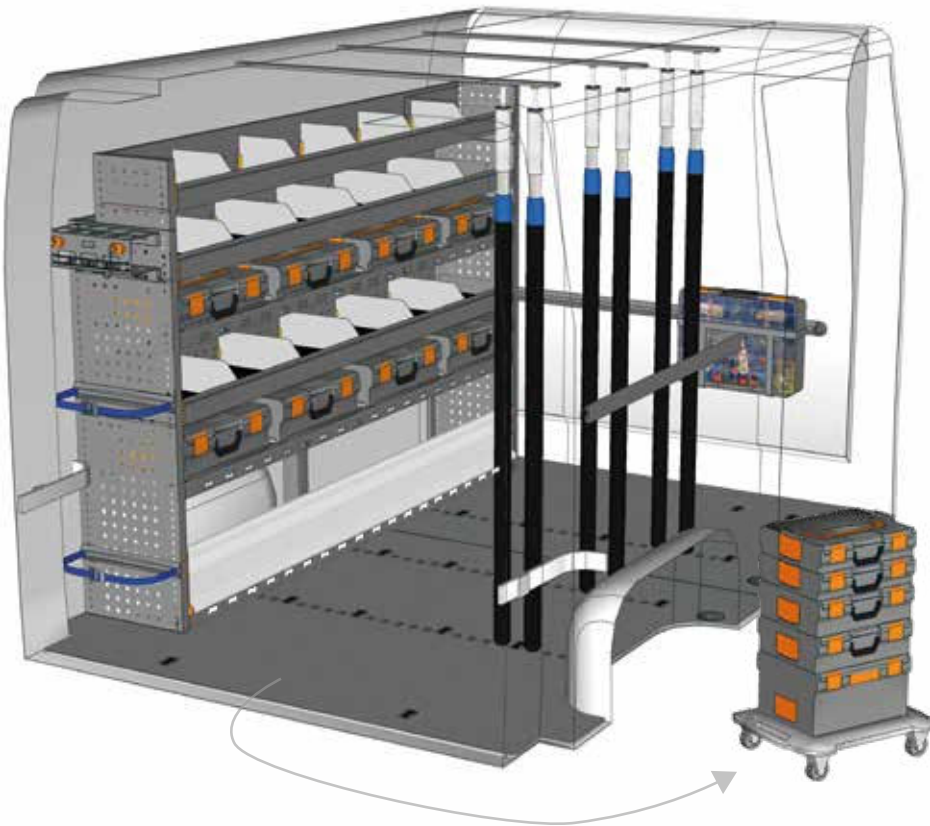

VOORBEELD - EXAMPLE

EXAMPLE MA L1H1 M1*



- | | |
|----------------|-------------|
| 1 x MA 2014 M2 | 1 x BOX080 |
| 1 x MA 10G1 A0 | 1 x CPV080 |
| 1 x V22585 | 2 x V22136 |
| 6 x V22017 | 2 x V22124 |
| 1 x V18029 15 | 2 x V22148 |
| 1 x V18029 10 | 1 x YELLOW |
| 4 x V22106 | 4 x V225820 |
| 3 x V18025 15 | |

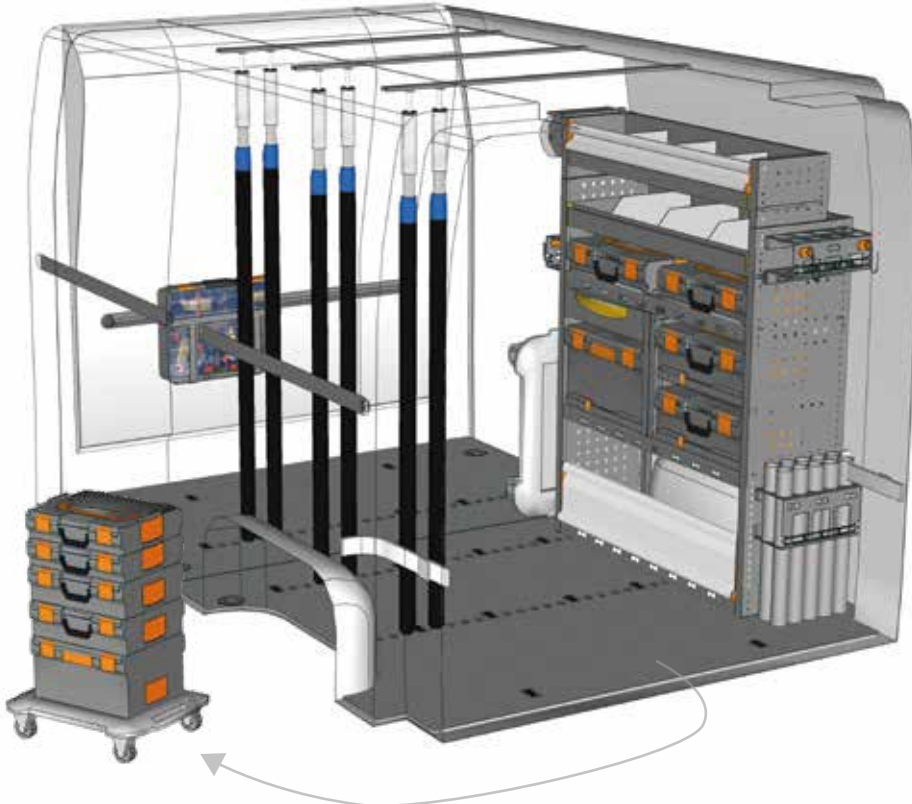

VOORBEELD - EXAMPLE

EXAMPLE MA L1H1 M2*



- | | |
|----------------|-------------|
| 1 x MA 1014 M1 | 1 x BOX080 |
| 1 x MA 10G1 A0 | 1 x CPV080 |
| 1 x V22585 | 2 x V22136 |
| 6 x V22017 | 2 x V22124 |
| 2 x V18029 10 | 2 x V22148 |
| 1 x V18029 15 | 1 x YELLOW |
| 6 x V22106 | 4 x V225820 |
| 3 x V18025 15 | |

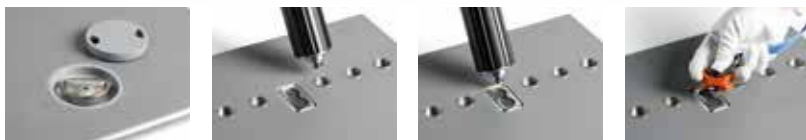

Zie pagina's 10/11
see pages 10/11

* Inclusief bevestigingsmateriaal - Fixing kit included

Heeft u uw ideale inrichting niet gevonden?
Voor bedrijfswageninrichtingen op maat neemt u contact op met onze vakmensen.
Op de achterzijde vindt u de adresgegevens of bezoek onze website www.storevannederland.nl

Didn't find the equipment you're looking for?
Leave it to our experts.
See the back of this catalogue and contact the nearest StoreVan point or visit our website.



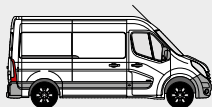

INRICHTINGSVOORBEELDEN - FITTINGS EXAMPLES

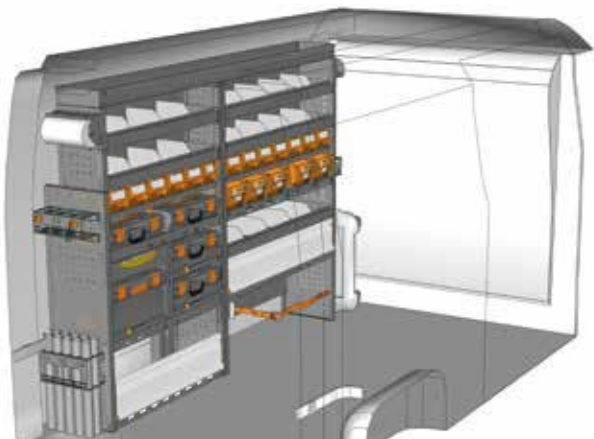

VOORBEELD - EXAMPLE

MA 2217 M1*

B=2241 T=365 H=1690 mm - W=2241 D=365 H=1690 mm

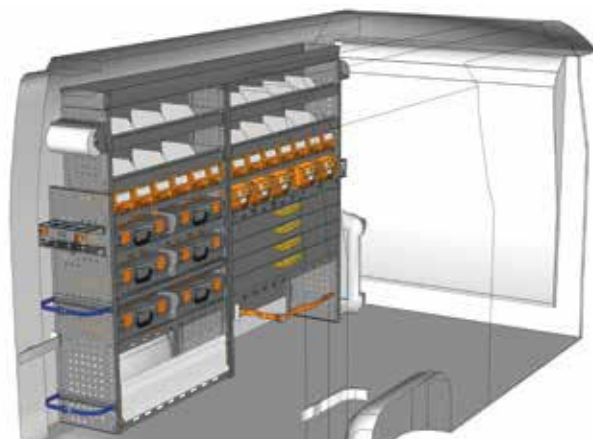
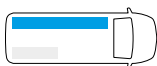

VOORBEELD - EXAMPLE

MA 2217 M2*

B=2241 T=365 H=1690 mm - W=2241 D=365 H=1690 mm

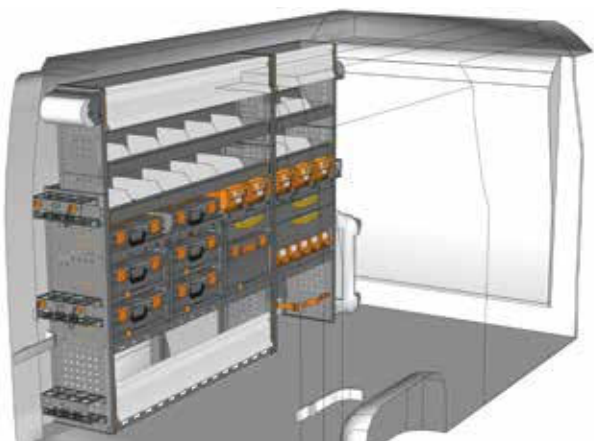
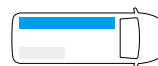

VOORBEELD - EXAMPLE

MA 2217 M3*

B=2241 T=365 H=1700 mm - W=2241 D=365 H=1700 mm

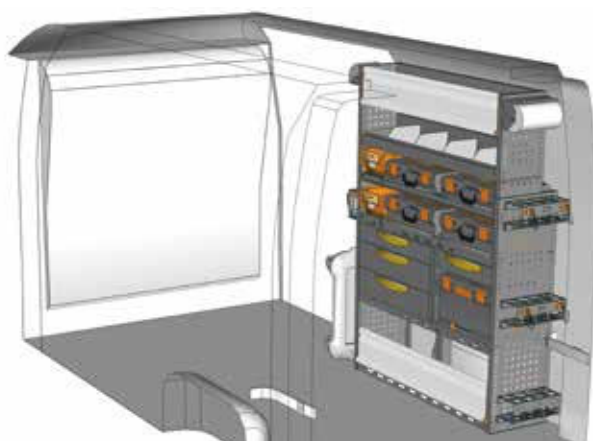
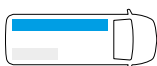

VOORBEELD - EXAMPLE

MA 1217 M1*

B=1225 T=365 H=1700 mm - W=1225 D=365 H=1700 mm

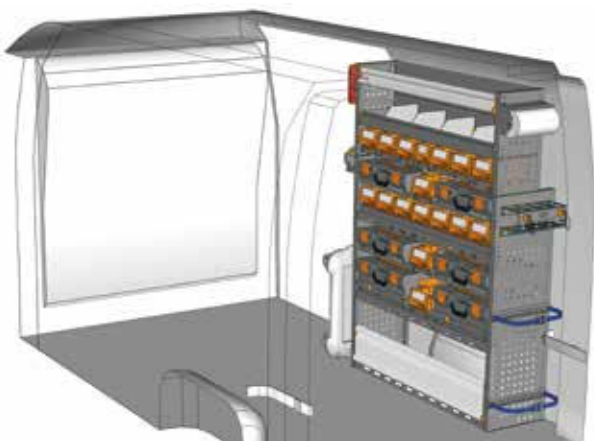
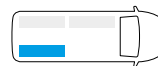

VOORBEELD - EXAMPLE

MA 1217 M2*

B=1225 T=365 H=1700 mm - W=1225 D=365 H=1700 mm

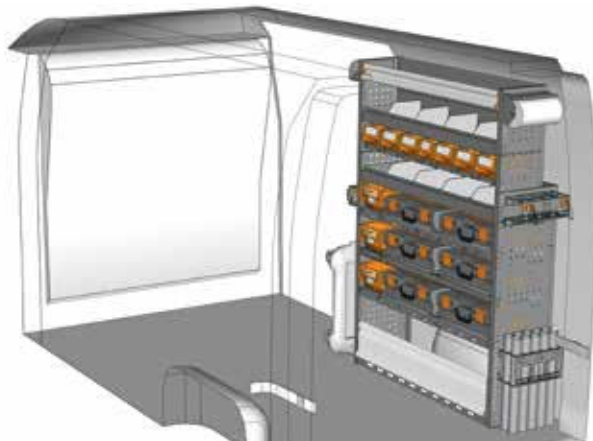
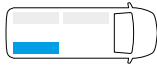

VOORBEELD - EXAMPLE

MA 1217 M3*

B=1225 T=365 H=1700 mm - W=1225 D=365 H=1700 mm

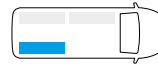

* Inclusief bevestigingsmateriaal - Fixing kit included

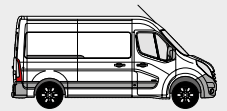

INRICHTINGSVOORBEELDEN - FITTINGS EXAMPLES

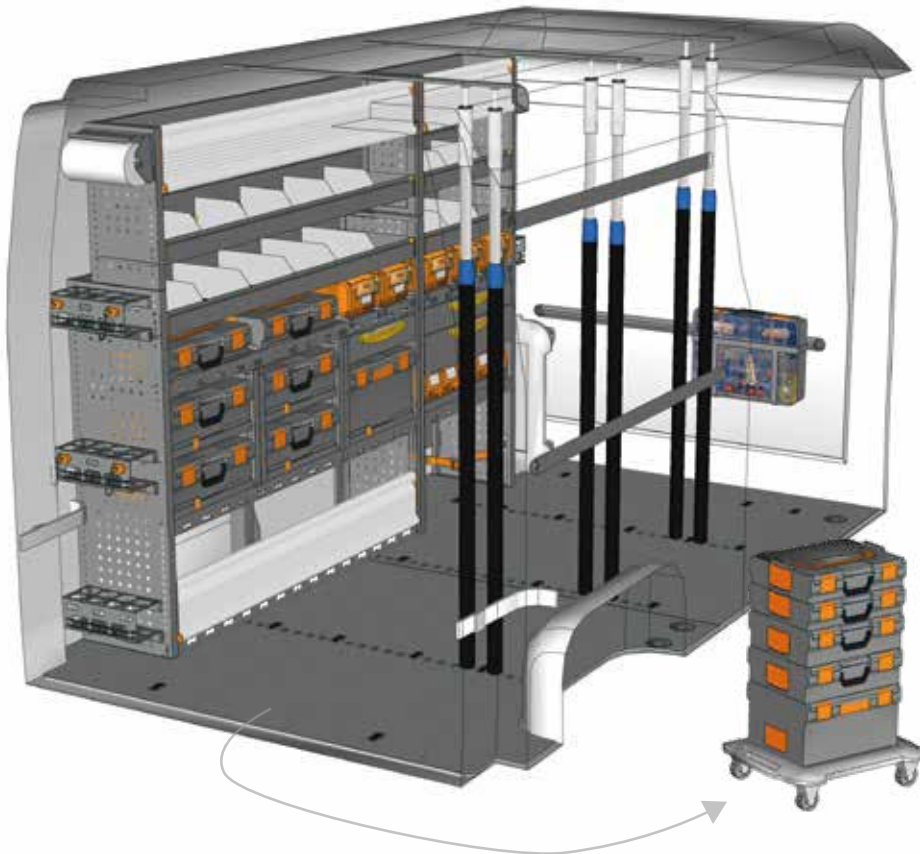

VOORBEELD - EXAMPLE

EXAMPLE MA L2H2 M1*



- | | |
|----------------|-------------|
| 1 x MA 2217 M3 | 1 x CPV080 |
| 1 x MA 20G1 A0 | 2 x V22136 |
| 1 x V22585 | 2 x V22124 |
| 6 x V22017 | 2 x V22148 |
| 3 x V18029 15 | 1 x YELLOW |
| 6 x V22106 | 4 x V225820 |
| 3 x V18025 15 | |
| 1 x BOX080 | |

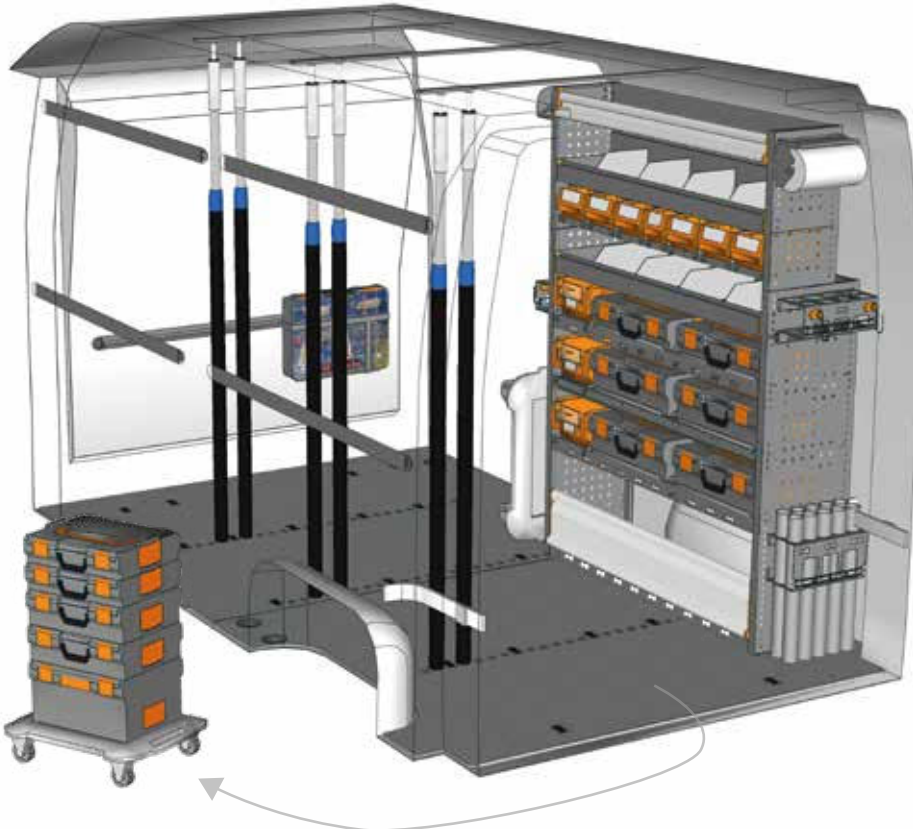

VOORBEELD - EXAMPLE

EXAMPLE MA L2H2 M2*



- | | |
|----------------|-------------|
| 1 x MA 1217 M3 | 1 x CPV080 |
| 1 x MA 20G1 A0 | 2 x V22136 |
| 1 x V22585 | 2 x V22124 |
| 6 x V22017 | 2 x V22148 |
| 5 x V18029 15 | 1 x YELLOW |
| 10 x V22106 | 4 x V225820 |
| 3 x V18025 15 | |
| 1 x BOX080 | |

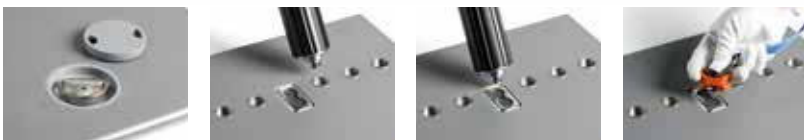

Zie pagina's 10/11
see pages 10/11

* Inclusief bevestigingsmateriaal - Fixing kit included

Heeft u uw ideale inrichting niet gevonden?
Voor bedrijfswageninrichtingen op maat neemt u contact op met onze vakmensen.
Op de achterzijde vindt u de adresgegevens of bezoek onze website www.storevannederland.nl

Didn't find the equipment you're looking for?
Leave it to our experts.
See the back of this catalogue and contact the nearest StoreVan point or visit our website.



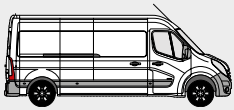

INRICHTINGSVOORBEELDEN - FITTINGS EXAMPLES

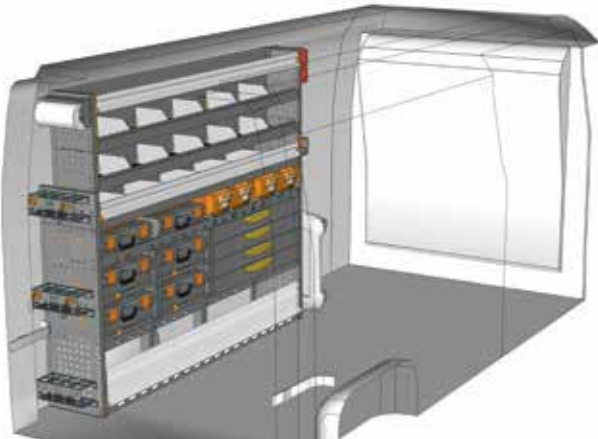

VOORBEELD - EXAMPLE

MA 2017 M1*

B=2032 T=365 H=1700 mm - W=2032 D=365 H=1700 mm

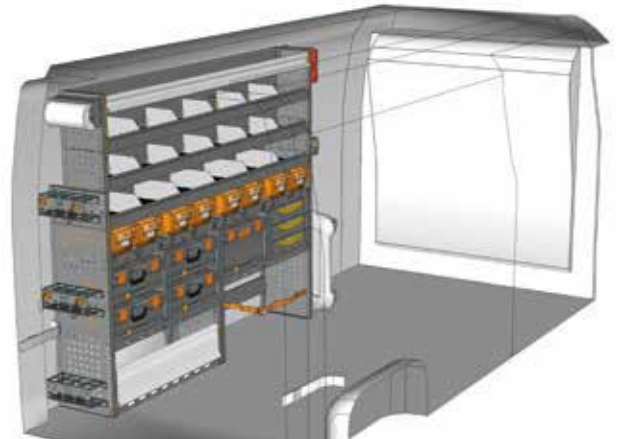
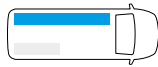

VOORBEELD - EXAMPLE

MA 2017 M2*

B=2032 T=365 H=1700 mm - W=2032 D=365 H=1700 mm

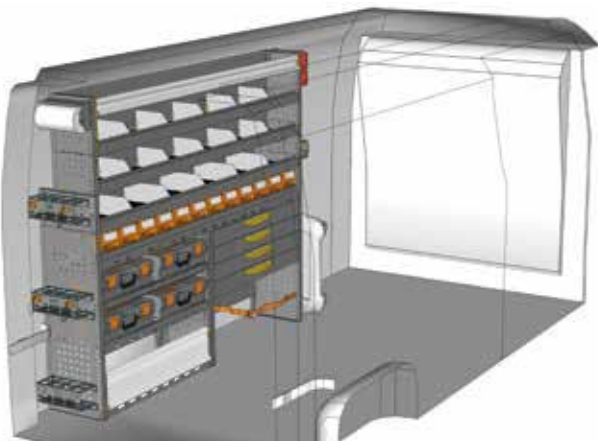

VOORBEELD - EXAMPLE

MA 2017 M3*

B=2032 T=365 H=1700 mm - W=2032 D=365 H=1700 mm

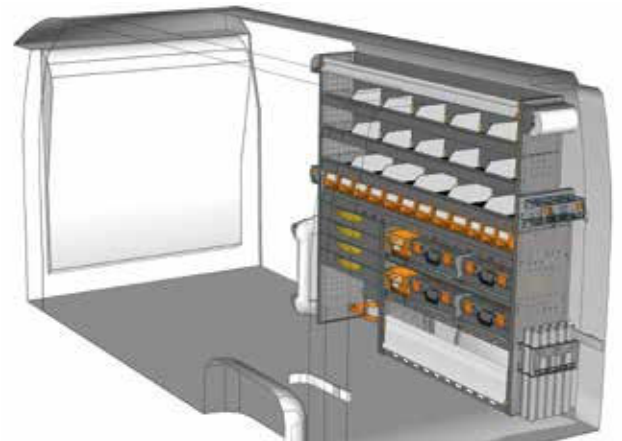
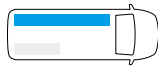

VOORBEELD - EXAMPLE

MA 1917 M1*

B=1942 T=365 H=1700 mm - W=1942 D=365 H=1700 mm

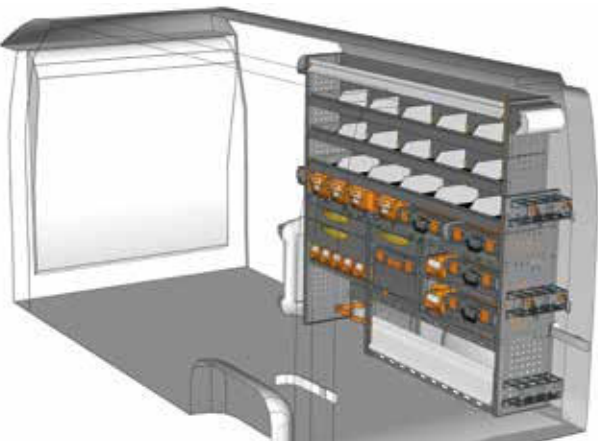
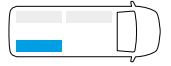

VOORBEELD - EXAMPLE

MA 1917 M2*

B=1942 T=365 H=1700 mm - W=1942 D=365 H=1700 mm

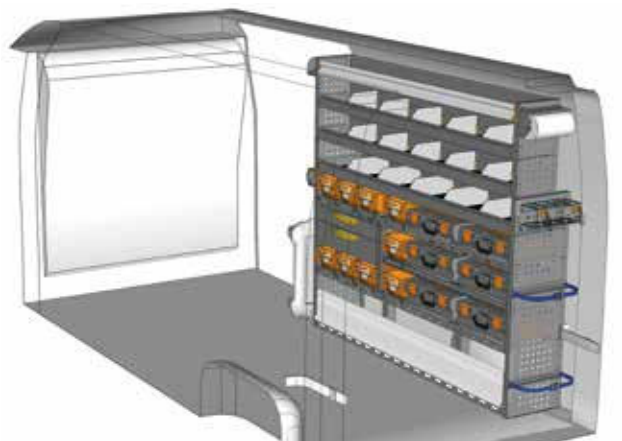
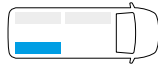

VOORBEELD - EXAMPLE

MA 1917 M3*

B=1942 T=365 H=1700 mm - W=1942 D=365 H=1700 mm



* Inclusief bevestigingsmateriaal - Fixing kit included

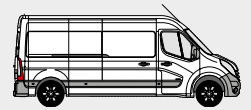

INRICHTINGSVOORBEELDEN - FITTINGS EXAMPLES

BEDRIJFSWAGEN - PANEL VAN
RENAULT MASTER

MOBILE

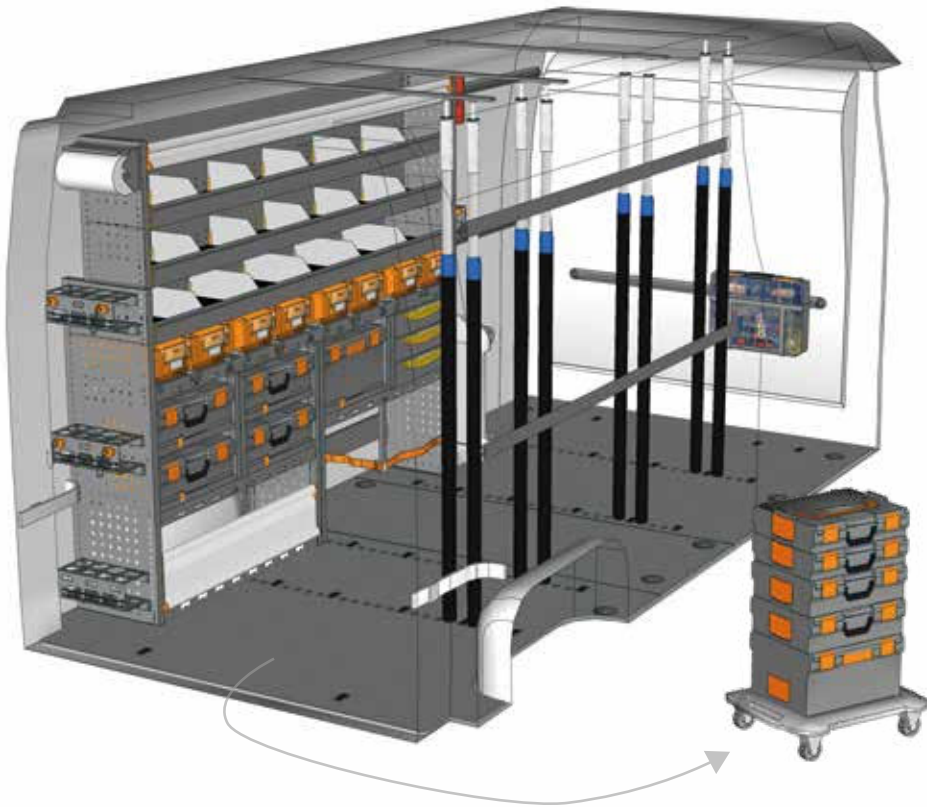

VOORBEELD - EXAMPLE

EXAMPLE MA L3H2 M1*



- | | |
|----------------|-------------|
| 1 x MA 2017 M2 | 1 x BOX080 |
| 1 x MA 30G1 A0 | 1 x CPV080 |
| 1 x V22585 | 2 x V22136 |
| 8 x V22017 | 2 x V22124 |
| 3 x V18029 15 | 2 x V22148 |
| 2 x V18029 20 | 1 x YELLOW |
| 10 x V22106 | 4 x V225820 |
| 4 x V18025 15 | |

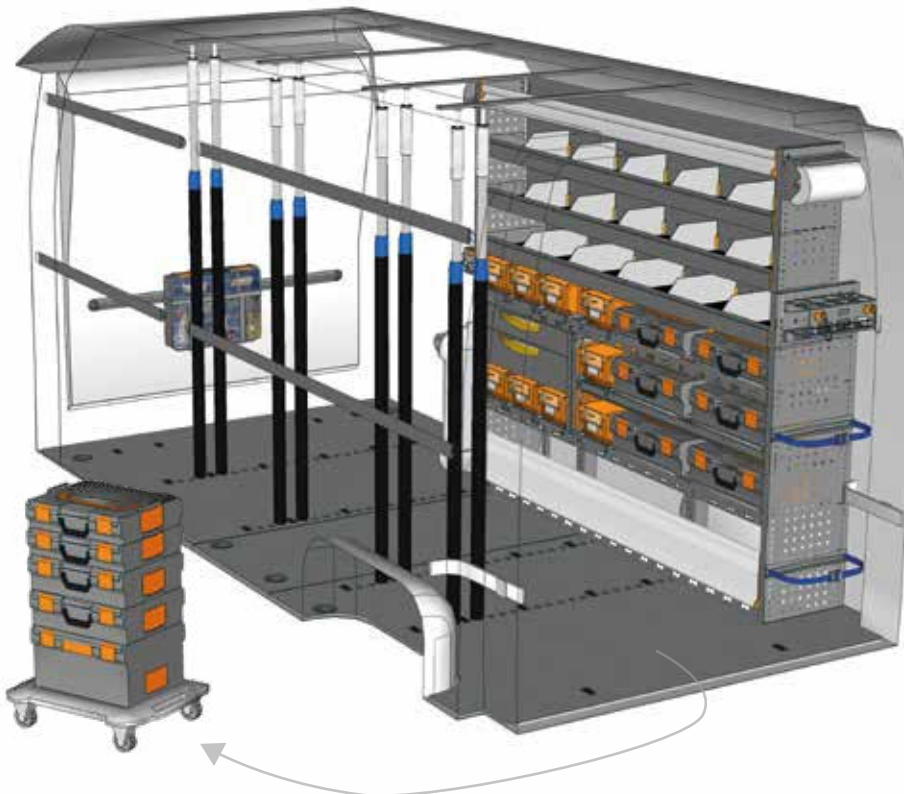

VOORBEELD - EXAMPLE

EXAMPLE MA L3H2 M2*



- | | |
|----------------|-------------|
| 1 x MA 1917 M3 | 1 x BOX080 |
| 1 x MA 30G1 A0 | 1 x CPV080 |
| 1 x V22585 | 2 x V22136 |
| 8 x V22017 | 2 x V22124 |
| 3 x V18029 15 | 2 x V22148 |
| 2 x V18029 20 | 1 x YELLOW |
| 10 x V22106 | 4 x V225820 |
| 4 x V18025 15 | |

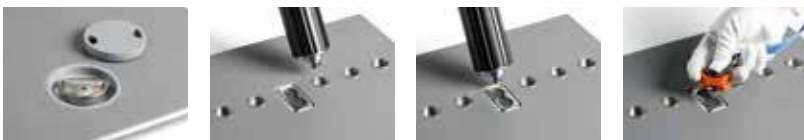

Zie pagina's 10/11
see pages 10/11

* Inclusief bevestigingsmateriaal - Fixing kit included

Heeft u uw ideale inrichting niet gevonden?
Voor bedrijfswageninrichtingen op maat neemt u contact op met onze vakmensen.
Op de achterzijde vindt u de adresgegevens of bezoek onze website www.storevannederland.nl

Didn't find the equipment you're looking for?
Leave it to our experts.
See the back of this catalogue and contact the nearest StoreVan point or visit our website.



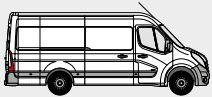

INRICHTINGSVOORBEELDEN - FITTINGS EXAMPLES

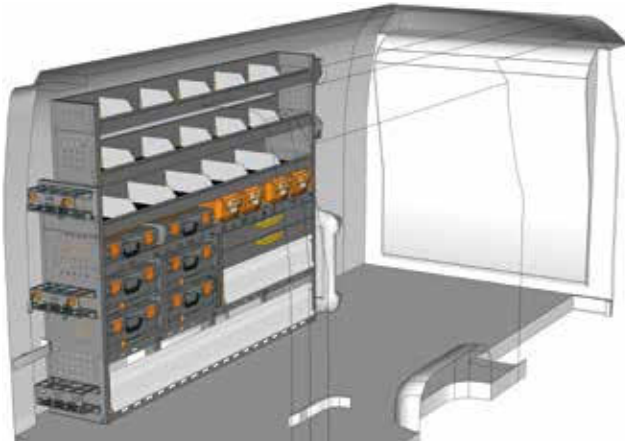

VOORBEELD - EXAMPLE

MA 2016 M1*

B=2032 T=365 H=1600 mm - W=2032 D=365 H=1600 mm

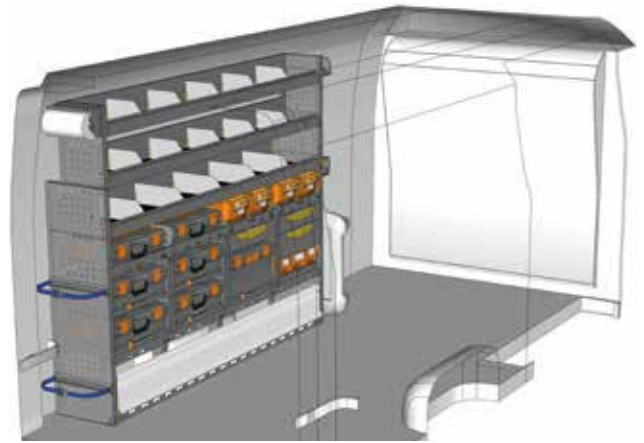
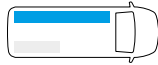

VOORBEELD - EXAMPLE

MA 2016 M2*

B=2032 T=365 H=1600 mm - W=2032 D=365 H=1600 mm

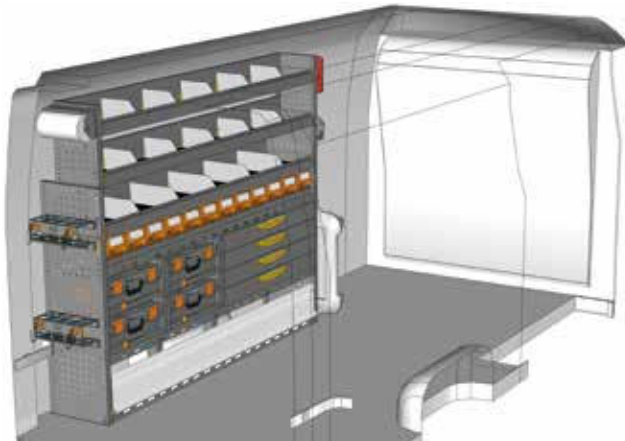
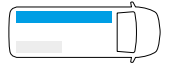

VOORBEELD - EXAMPLE

MA 2016 M3*

B=2032 T=365 H=1600 mm - W=2032 D=365 H=1600 mm

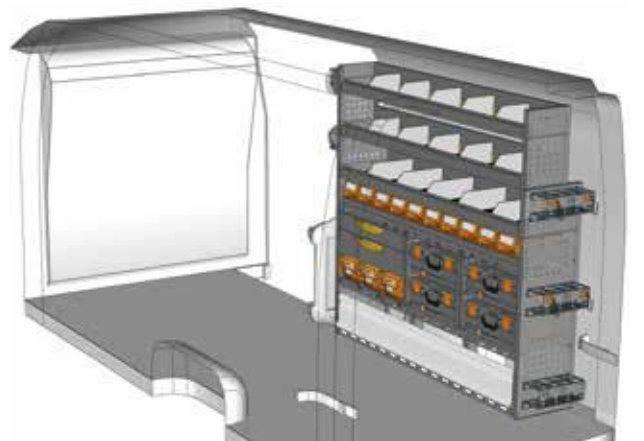
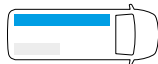

VOORBEELD - EXAMPLE

MA 1716 M1*

B=1733 T=365 H=1600 mm - W=1733 D=365 H=1600 mm

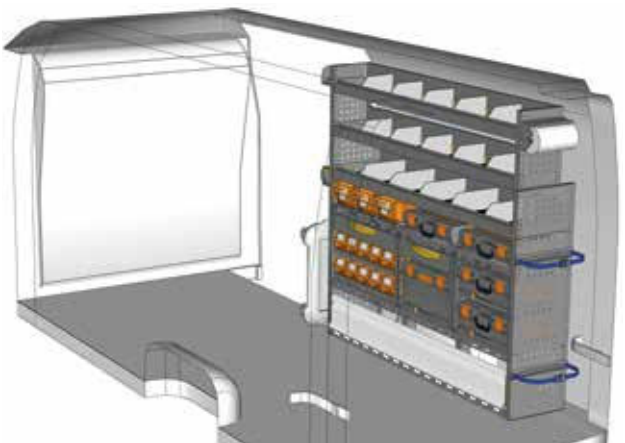
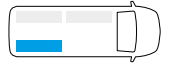

VOORBEELD - EXAMPLE

MA 1716 M2*

B=1733 T=365 H=1600 mm - W=1733 D=365 H=1600 mm

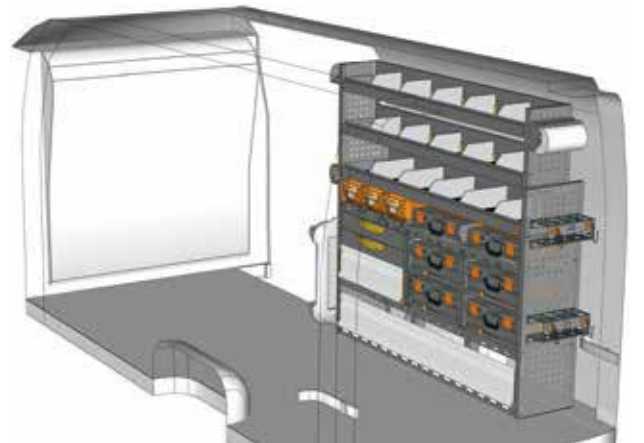
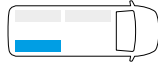

VOORBEELD - EXAMPLE

MA 1716 M3*

B=1733 T=365 H=1600 mm - W=1733 D=365 H=1600 mm

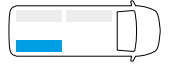

* Inclusief bevestigingsmateriaal - Fixing kit included

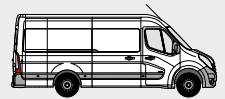

INRICHTINGSVOORBEELDEN - FITTINGS EXAMPLES

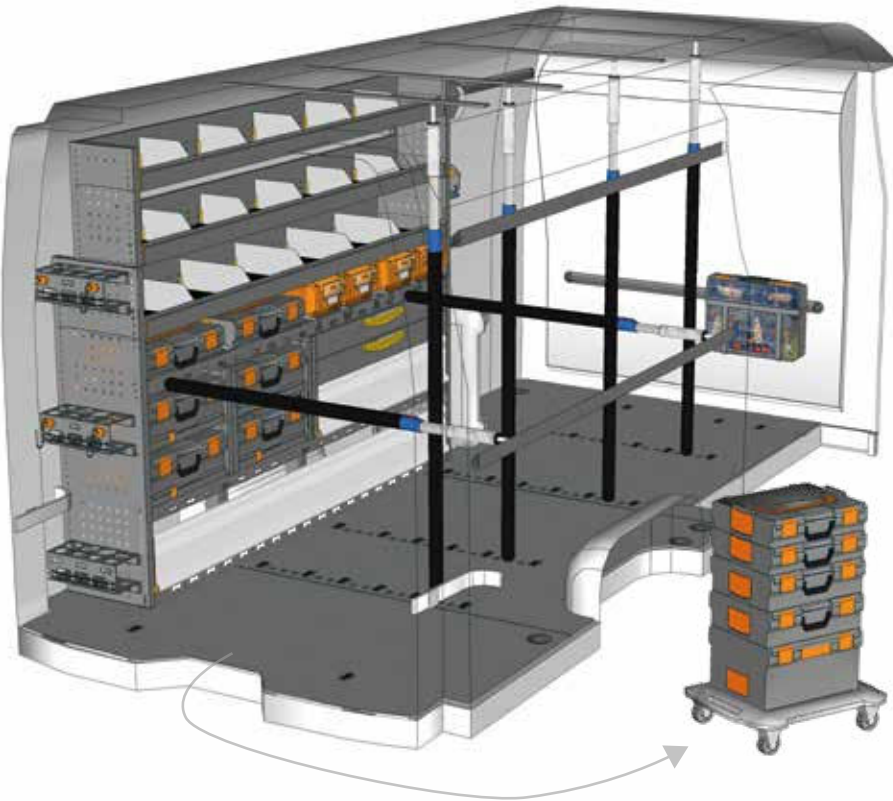

VOORBEELD - EXAMPLE

EXAMPLE MA L2LH2 M1*



- | | |
|----------------|---------------|
| 1 x MA 2016 M1 | 4 x V18025 15 |
| 1 x MA 2LG1 J0 | 1 x BOX080 |
| 1 x V22585 | 1 x CPV080 |
| 2 x V22131 | 2 x V22136 |
| 4 x V22017 | 2 x V22124 |
| 3 x V18029 15 | 2 x V22148 |
| 2 x V18029 20 | 1 x YELLOW |
| 10 x V22106 | 4 X V225820 |

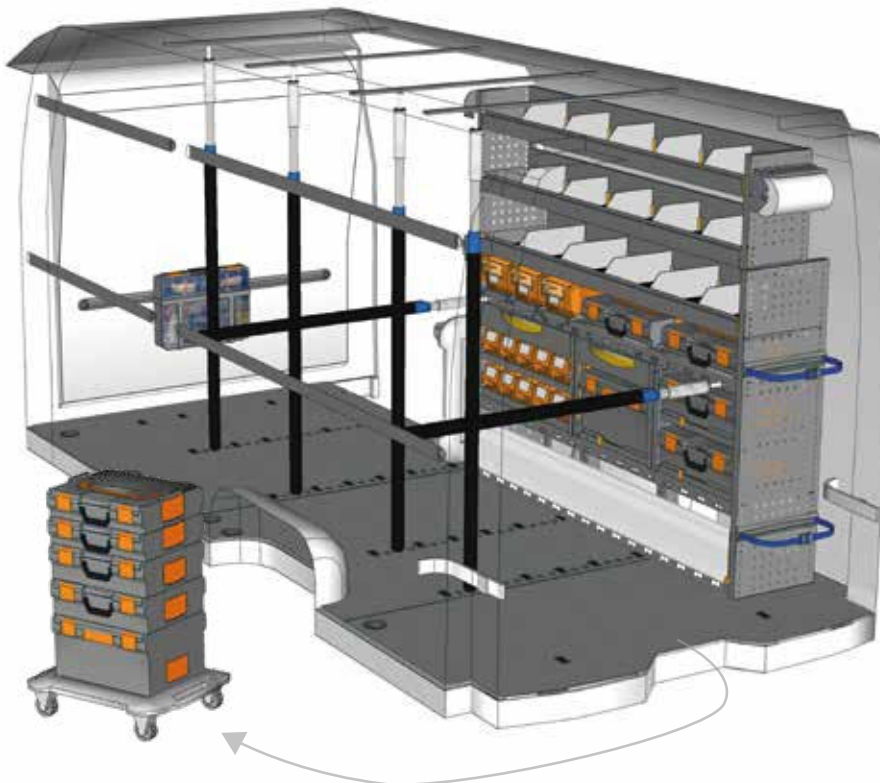

VOORBEELD - EXAMPLE

EXAMPLE MA L2LH2 M2*



- | | |
|----------------|---------------|
| 1 x MA 1716 M2 | 4 x V18025 15 |
| 1 x MA 2LG1 J0 | 1 x BOX080 |
| 1 x V22585 | 1 x CPV080 |
| 2 x V22131 | 2 x V22136 |
| 4 x V22017 | 2 x V22124 |
| 3 x V18029 15 | 2 x V22148 |
| 2 x V18029 20 | 1 x YELLOW |
| 10 x V22106 | 4 x V225820 |

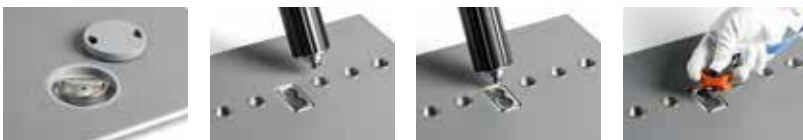

Zie pagina's 10/11
see pages 10/11

* Inclusief bevestigingsmateriaal - Fixing kit included

Heeft u uw ideale inrichting niet gevonden?
Voor bedrijfswageninrichtingen op maat neemt u contact op met onze vakmensen.
Op de achterzijde vindt u de adresgegevens of bezoek onze website www.storevannederland.nl

Didn't find the equipment you're looking for?
Leave it to our experts.
See the back of this catalogue and contact the nearest StoreVan point or visit our website.





VOERTUIG VEHICLE	DAKDRAGER ROOF RACK	AFMETINGEN DIMENSIONS	GEWICHT WEIGHT	DRAAGVERMOGEN LOAD CAPACITY
	ART.			
Voertuigtype - Model L1 H1	POT 219	2750x1700 mm	33,44 kg	166,00 kg
Voertuigtype - Model L1 H2	POT 220	3000x1600 mm	33,23 kg	166,00 kg
Voertuigtype - Model L2 H2	POT 214	3400x1600 mm	34,81 kg	165,00 kg
Voertuigtype - Model L3 H2	POT 215	4000x1600 mm	40,59 kg	159,00 kg
Voertuigtype - Model L4 H2	POT 216	4350x1600 mm	45,80 kg	154,00 kg

POT

- Dakdrager compleet met:
 - Aluminium dwarsliggers met bevestigingsonderdelen en rubberen profiel
 - Aluminium zijhekken
 - Aluminium geleidingsrol
 - Bevestigingsmaterialen in roestvrijstaal
- Roof rack complete of:
 - aluminium crossbars with fixing parts and rubber profile
 - aluminium side rails
 - aluminium loading roller
 - fixing screws in stainless steel



VOERTUIG VEHICLE	LADDERREK LADDER RACK	AFMETINGEN DIMENSIONS	GEWICHT WEIGHT	DRAAGVERMOGEN LOAD CAPACITY
	ART.			
Voertuigtype - Model L1 H1	POS 219	2750x1680 mm	61,35 kg	138,00 kg
Voertuigtype - Model L1 H2	POS 220	3000x1580 mm	60,61 kg	139,00 kg
Voertuigtype - Model L2 H2	POS 214	3400x1580 mm	64,30 kg	135,00 kg
Voertuigtype - Model L3 H2	POS 215	4000x1580 mm	69,08 kg	131,00 kg
Voertuigtype - Model L4 H2	POS 216	4350x1580 mm	73,56 kg	126,00 kg

POS

- Ladderrek compleet met:
 - Aluminium dwarsliggers met bevestigingsonderdelen en rubberen profiel
 - Aluminium zijhek
 - Aluminium geleidingsrol
 - Ladderrail van aluminium en roestvrijstaal
 - Bevestigingsmaterialen in roestvrijstaal
- Ladder rack complete of:
 - aluminium crossbars with fixing parts and rubber profile
 - aluminium side rail
 - aluminium loading roller
 - ladder rack rail made of aluminium and stainless steel
 - fixing screws in stainless steel







ART. NR. / ITEM NO. **PAP 265 00**

- Papierrolhouder met papier Ø 130 mm
- Paper towel holder kit with paper towel Ø 130 mm



ART. NR. / ITEM NO. **CAB 220 00**

- Slanghaspel
- Cable saddle



ART. NR. / ITEM NO. **SPR 365 00**

- Spuitbus- of kitpatroonhouder D=365 mm
- Spray-can holder kit D=365 mm



ART. NR. / ITEM NO. **PAP 365 00**

- Papierrolhouder met papier Ø 240 mm
- Paper towel holder kit with paper towel Ø 240 mm



ART. NR. / ITEM NO. **CAB 296 00**

- Slanghaspel kit
- Cable saddle-kit



ART. NR. / ITEM NO. **SIL 296 00**

- Spuitbus- en kitpatroonhouder
- Kit silicone - spray cans holder



ART. NR. / ITEM NO. **LED 001 00**

- LED-lamp L=600 mm, IP20, 12V
- Led lamp IP20 12V W=600 mm



ART. NR. / ITEM NO. **WAS 365 00**

- Handenwaskit
- Hand wash kit



ART. NR. / ITEM NO. **SPR 160 00**

- Spuitbus- of kitpatroonhouder
- Spray-can holder kit (2 slots)



ART. NR. / ITEM NO. **AID 265 00**

- EHBO-koffer
- First aid kit



ART. NR. / ITEM NO. **DOC 265 00**

- Documentenhouder A4
- A4 documents holder



ART. NR. / ITEM NO. **DOC 365 00**

- Documentenhouder A4 - 362x68x209 mm H
- A4 documents holder - 362x68x209 mm H

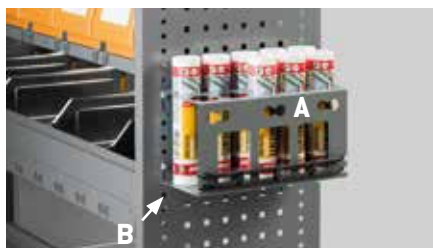
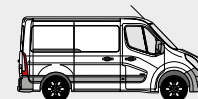

Kitpatroon houder
Kit silicone holder

A + B

ART. NR. / ITEM NO. **BAR 296 00**

A

- Kokerhouder t.b.v. kitpatronen
- Support for silicone cartridges / threaded-bar holder

ART. NR. / ITEM NO. **BAR 296 02**

B

- Adapter t.b.v. kitpatronen
- Adapter for silicone cartridges

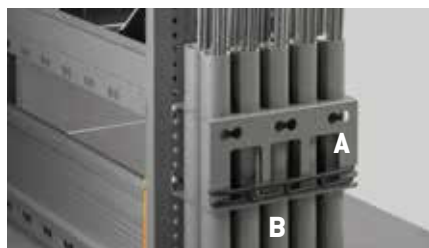

Kokerhouder t.b.v. draadeinden
Threaded-bar holder kit

A + B

ART. NR. / ITEM NO. **BAR 296 00**

A

- Kokerhouder t.b.v. draadeinden
- Support for silicone cartridges / threaded-bar holder

ART. NR. / ITEM NO. **BAR 296 01**

B

- Houder met 5 kokers voor draadeinden
- 5 Pipe for threaded-bar holder

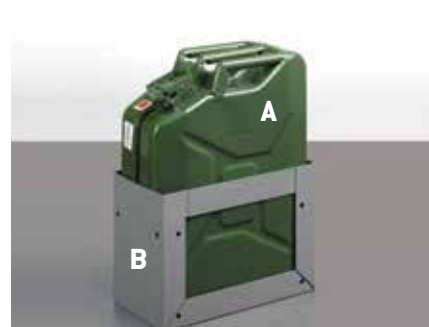

ART. NR. / ITEM NO. **OIL 20L 00**

A

- Jerrycanhouder incl. stalen jerrycan 20L
- Metal can capacity 20 LT

ART. NR. / ITEM NO. **OIL 365 00**

B

- Jerrycanhouder
- Can holder

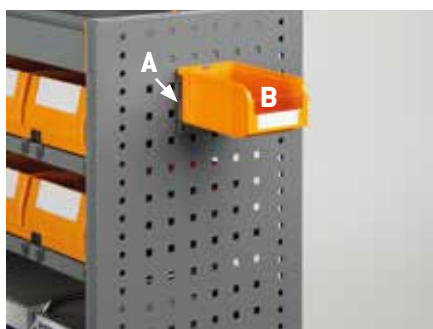

ART. NR. / ITEM NO. **BL 7433 00**

A

- Houder voor 1 container grootte 1PL
- Container rail for 1 container size 1PL

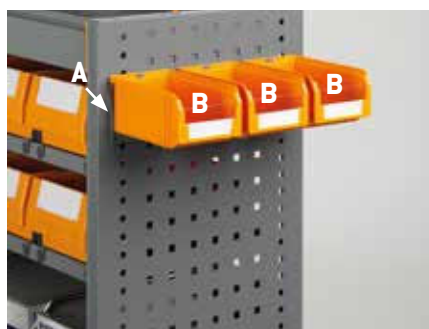

ART. NR. / ITEM NO. **BL 7434 00**

A

- Houder voor 3 containers grootte 1PL
- Container rail for 3 containers size 1PL

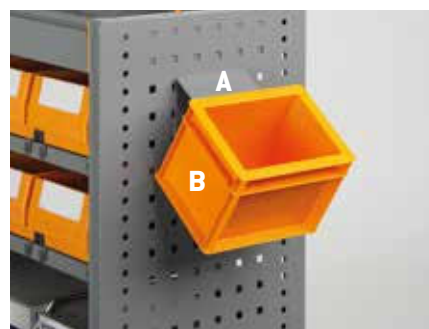

ART. NR. / ITEM NO. **BL 7432 00**

A

- Houder voor 1 Athena container
- Container rail for 1 container Athena

ART. NR. / ITEM NO. **PM 1751 00**

B

- Polypropyleen container grootte 1PL
- Polypropylene container size 1PL

ART. NR. / ITEM NO. **PM 1751 00**

B

- Polypropyleen container grootte 1PL
- Polypropylene container size 1PL

ART. NR. / ITEM NO. **PA 2251 A0**

B

- Polypropyleen Athena container
- Polypropylene boxes series Athena



ART. NR. / ITEM NO. **MAG 020**

- Set à 10 magneten Ø 20 mm
- Set of 10 magnets Ø 20 mm

ART. NR. / ITEM NO. **MAG 025**

- Set à 10 magneten Ø 25 mm
- Set of 10 magnets Ø 25 mm



ART. NR. / ITEM NO. **RUB 160 00**

- Anti-slip mat holder - 158x50x171 mm H
- Non-slip mats holder - 158x50x171 mm H

ART. NR. / ITEM NO. **RUB 000 00**

- 6 anti-slip matjes - 150x150x3 mm H
- 6 non-slip mats kit - 150x150x3 mm H



GEBRUIK VAN DE ANTI-SLIP MAT

Anti-slip matten worden gebruikt om de coëfficiënt van de wrijving te verhogen tot μD 0.6 volgens de DIN EN 12195-1: 2004 en VDI 2700 ff norm. De meetmethode moet de richtlijn "VDI 2700 pagina 15" volgen.

USE CASE FOR NON-SLIP MAT

Non-slip mats are used to increase the coefficient of friction up to μD 0.6 following the calculus DIN EN 12195-1: 2004 and VDI 2700 ff. The measuring procedure should follow the directive "VDI 2700 - 15".



ART. NR. / ITEM NO. **FIR 000** A

- Houder met sjaorband voor flessen en/of brandblussers
- Gas cylinder kit



ART. NR. / ITEM NO. **V18029 03** A

- All Safe Bar met middelgroot gat L=365 mm
- Horizontal load restraining bar with medium hole connector W=365 mm

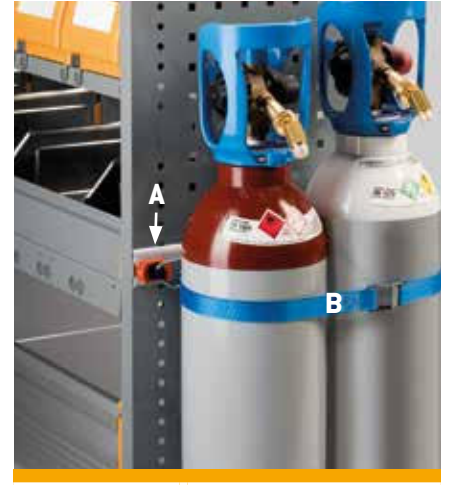

ART. NR. / ITEM NO. **V18029 03** A

- All Safe Bar met connector L=365 mm
- Horizontal load restraining bar with medium hole connector W=365 mm

ART. NR. / ITEM NO. **FIR 4KG** B

- Brandblusser 4kg
- Fire extinguisher [powder] 4 KG

ART. NR. / ITEM NO. **V18029 04** A

- All Safe Bar met middelgroot gat L=445 mm
- Horizontal load restraining bar with medium hole connector W=445 mm

ART. NR. / ITEM NO. **V18029 04** A

- All Safe Bar met connector L=445 mm
- Horizontal load restraining bar with medium hole connector W=445 mm

ART. NR. / ITEM NO. **V22868** B

- Medium sjaorband met ratel t.b.v. All Safe Bar.
- Medium connector ratchet load restraining belt

ART. NR. / ITEM NO. **V22869** B

- Medium sjaorband met snapsluiting
- Medium connector clamp load restraining belt



Voorbeeld met
2 ART.NR FIR 000
Example with
2 ITEM NO. FIR 000



Voorbeeld met
2 ART.NR V18029 03
2 ART.NR V22868
Example with
2 ITEM NO. V18029 03
2 ITEM NO. V22868



Voorbeeld met
2 ART.NR V18029 03
2 ART.NR V22869
Example with
2 ITEM NO. V18029 03
2 ITEM NO. V22869

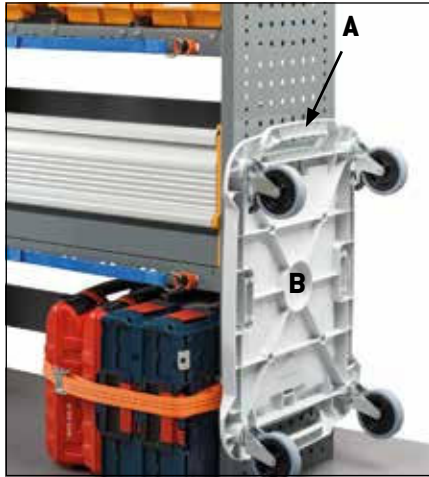

ART. NR. / ITEM NO. **00 ROLL SU** A

- Draagset t.b.v. Store Box Roll
- Set of supports for STORE BOX ROLL

ART. NR. / ITEM NO. **00 ROLL 00** B

- Trolley met wielen en remmen t.b.v. Store Box 102/136/238/374
- Trolley with castors with brakes for tool case BOX 102-136-238-374







RENAULT MASTER

LEVERINGSVOORWAARDEN

- Wandbekleding en bodemplaten worden als losse pakketten geleverd.
- Dak- en ladderrekken worden **flat-packed** (prefab) geleverd.
- Modules worden **geprefabriceerd** en compleet **met bevestigingsmaterialen** geleverd.
- **Gecertificeerde montage** door gecertificeerde technici mogelijk.
- Producten worden **verpakt** geleverd.
- **3 jaar garantie** op de inrichtingen van Store Van.
- De genoemde draagvermogens in deze brochure hebben betrekking op **gelijkmatig verdeelde last**.

SUPPLY CONDITIONS

- Flooring and linings supplied in several pieces.
- Roof and ladder racks supplied **flat-packed**.
- Modules are supplied **preassembled** complete of fixing material to the vehicle.
- For products installation, please get in touch with our **approved installer's network**.
- Products provided **with packaging**.
- Our products are covered by a **3-years warranty**.
- Load capacities refer to **uniformly distributed loads**.



FAMI S.R.L.

VIA STAZIONE ROSSANO, 13 – 36027 ROSÀ (VI) ITALY
TEL +39 0424 585455 R.A. – FAX +39 0424 585482
INFO@FAMISPA.COM – WWW.FAMISPA.COM

INFO@STOREVAN.COM – WWW.STOREVAN.COM

STOREVANNEDERLAND IS EEN DIVISIE VAN:
KÜSTER-EFFORT B.V. - T. 088 – 1301 400
E. INFO@STOREVANNEDERLAND.NL - WWW.STOREVANNEDERLAND.NL
VOLG ONS OP FACEBOOK, INSTAGRAM EN LINKEDIN

